

# 2013 **C**hip Resistors

## Product catalog

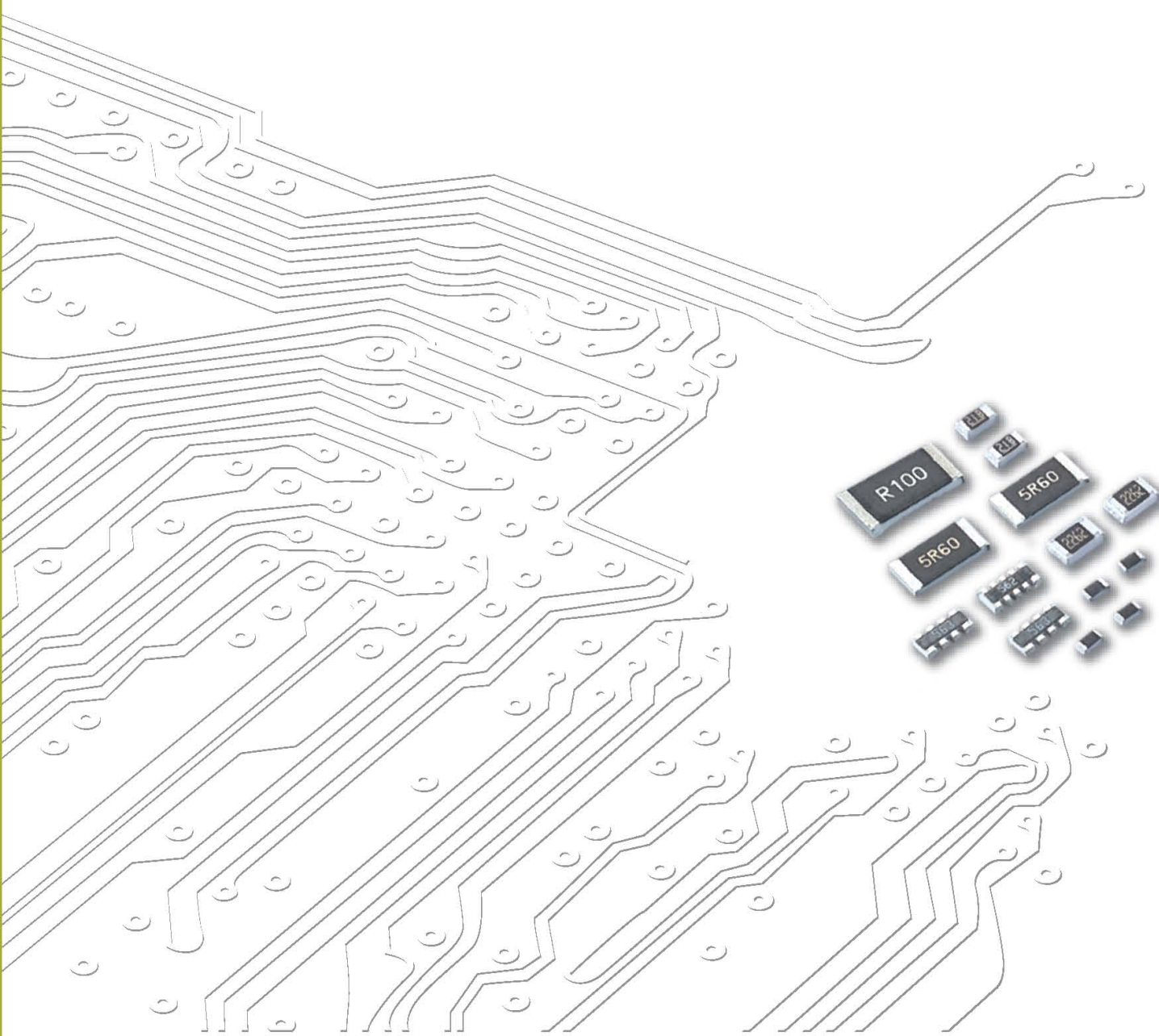

## Product Portfolio

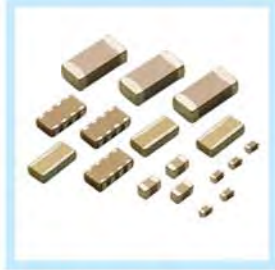

**Multilayer Ceramic Capacitors (MLCC)**



**Chip-Resistor**



**Disc Capacitors**



**RF Device and High Frequency Inductors**

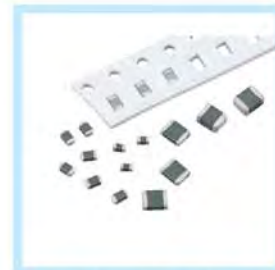

**Varistors and SMD-Varistors**

## IEC-63 Nominal Resistance / Capacitance

|            |     |     |     |     |     |     |     |     |     |     |     |     |     |     |     |     |     |     |     |     |     |     |     |     |
|------------|-----|-----|-----|-----|-----|-----|-----|-----|-----|-----|-----|-----|-----|-----|-----|-----|-----|-----|-----|-----|-----|-----|-----|-----|
| <b>E1</b>  | 100 |     |     |     |     |     |     |     |     |     |     |     |     |     |     |     |     |     |     |     |     |     |     |     |
| <b>E3</b>  | 100 |     |     | 220 |     |     | 470 |     |     |     |     |     |     |     |     |     |     |     |     |     |     |     |     |     |
| <b>E6</b>  | 100 | 150 | 220 | 330 | 470 | 680 |     |     |     |     |     |     |     |     |     |     |     |     |     |     |     |     |     |     |
| <b>E12</b> | 100 | 120 | 150 | 180 | 220 | 270 | 330 | 390 | 470 | 560 | 680 | 820 |     |     |     |     |     |     |     |     |     |     |     |     |
| <b>E24</b> | 100 | 110 | 120 | 130 | 150 | 160 | 180 | 200 | 220 | 240 | 270 | 300 | 330 | 360 | 390 | 430 | 470 | 510 | 560 | 620 | 680 | 750 | 820 | 910 |
| <b>E96</b> | 100 | 102 | 121 | 124 | 147 | 150 | 178 | 182 | 215 | 221 | 261 | 267 | 316 | 324 | 383 | 392 | 464 | 475 | 562 | 576 | 681 | 698 | 825 | 845 |
|            | 105 | 107 | 127 | 130 | 154 | 158 | 187 | 191 | 226 | 232 | 274 | 280 | 332 | 340 | 402 | 412 | 487 | 499 | 590 | 604 | 715 | 732 | 866 | 887 |
|            | 110 | 113 | 133 | 137 | 162 | 165 | 196 | 200 | 237 | 243 | 287 | 294 | 348 | 357 | 422 | 432 | 511 | 523 | 619 | 634 | 750 | 768 | 909 | 931 |
|            | 115 | 118 | 140 | 143 | 169 | 174 | 205 | 210 | 249 | 255 | 301 | 309 | 365 | 374 | 442 | 453 | 536 | 549 | 649 | 665 | 787 | 806 | 953 | 976 |

E6:  $\sqrt[6]{10} \approx 1.46$  E12:  $\sqrt[12]{10} \approx 1.21$

E1 series resistance: 1Ω, 10Ω, 100Ω, 1000Ω, 10000Ω, 100000Ω

## INDEX

| <b>Subject</b>   | <b>Page</b> |
|--|-------------|
| How to Order.....  | 1           |
| Chip resistors Selection Guide .....                                     | 2           |
| General Purpose Chip Resistors ( 1Ω ~10MΩ ) .....                        | 5           |
| Thick Film Low Ohm/ Power Low Ohm Chip Resistors ( 0.02Ω ~ 0.976Ω) ..... | 6           |
| Metal Low Ohm Current Sensing Chip resistors ( 0.001Ω ~ 0.050Ω) .....    | 7           |
| Chip Resistor Array:Convex Termination .....                             | 8           |
| WA06W Chip Resistor Array 16P8R .....                                    | 9           |
| Chip Resistor Array:Concave Termination .....                            | 10          |
| WT04X Chip Resistor Network .....  | 11          |
| WA04P Chip Attenuator .....  | 12          |
| Special Chip Resistors .....   | 13          |
| MR/SR Series of Automotive & Anti-Sulfuration Chip Resistors .....       | 13          |
| WR_R Series of Total Lead Free Chip Resistors .....                      | 13          |
| WKxxM Series of Trimmable Chip Resistors .....                           | 14          |
| WKxxV Series of High Voltage Chip Resistors.....                         | 14          |
| WFxxP Series of High Power Chip Resistors .....                          | 15          |
| WKxxS series of Surge Chip Resistors .....                               | 15          |
| High Precision Chip Resistors .....                                      | 16          |
| Test and Requirements .....  | 17          |
| Packing on Tape and Reel .....   | 19          |
| Footprint Design .....   | 20          |
| Storage and Handling Condition.....                                      | 21          |
| Recommendation of Soldering Profiles .....                               | 21          |

\*The specifications are subject to change or our products in it may be discontinued without advance notice. Please check with our sales representatives or product engineers before ordering.

\*This catalog has only typical specifications because there is no space for detailed specifications. Therefore, please approve our product specifications or transact the approval sheet for product specification before ordering.

## HOW TO ORDER

| WR   | 12  | X   | 1000  | F   | T   | L  |
|--|---|---|---|---|---|--|
| <b>Type code</b><br>WR : General 1~10MR<br>MR: Automotive<br>SR: Anti-Sulfuration<br>ZR: Non magnetic                                      | <b>Size code</b><br>25 : 2512 (6432)<br>20 : 2010 (5025)<br>18 : 1218 (3248)<br>12 : 1206 (3216)<br>10 : 1210 (3225)<br>08 : 0805 (2012)<br>06 : 0603 (1608)<br>04 : 0402 (1005)<br>02 : 0201 (0603)<br>01 : 01005 (0402) | <b>Functional code</b><br>X : 5% for 1 ~ 10MΩ<br>1% for 10 ~ 1MΩ<br>W : 1% for <10Ω and >1MΩ<br>Y : 5% for 1 ~ 10MΩ (Low profile)<br>Z : 1% for <10Ω or >1MΩ (Low profile)<br>F: TC100 1-10ohm, 1%<br>E: TC100, 100-1Mohm, 5%   | <b>Resistance</b><br>E24(J tol.) : 2 significant digits followed by No. of zeros and a blank<br>e.g. : 3ohm = 3R0_<br>10ohm = 100_<br>220ohm = 221_<br>56Kohm = 563_<br>("_" means blank)<br>E24+E96 (F tol.) : 3 significant digits followed by No. of zeros<br>e.g. : 3Ω = 3R00<br>10Ω = 10R0<br>220Ω = 2200<br>56KΩ = 5602 | <b>Tolerance</b><br>F : ± 1%<br>J : ± 5%<br>P : Jumper<br>H : +5% ~ 0%  | <b>Packaging code</b><br>P : 4" reel taping<br>T : 7" reel taping<br>A : 7" reel taping 15Kpcs<br>D : 7" reel taping 20Kpcs<br>E : 7" up side down taping<br>V : 7" reel taping 1Kpcs<br>Q : 10" reel taping<br>G : 13" reel taping<br>H : 0402-50K/13" reel<br>R : 0603 2mm pitch taping<br>B : Bulk<br>K : Bulkcase<br>C : Bulk after measuring | <b>Termination code</b><br>L = Sn base (Lead free)<br>R = Pb ≤100ppm (total)<br>W = Wide term.<br>A = Anti-leaching          |
| WW   | 12  | M   | R002  | F   | T   | L  |
| <b>Type code</b><br>WW: R < 1Ω<br>MW: R < 1Ω, AUTO<br>SW: R < 1Ω, Anti-Sulfu   | <b>Size code</b><br>25 : 2512 (6432)<br>20 : 2010 (5025)<br>18 : 1218 (3248)<br>12 : 1206 (3216)<br>10 : 1210 (3225)<br>08 : 0805 (2012)<br>06 : 0603 (1608)<br>04 : 0402 (1005)  | <b>Functional code</b><br>X: Thick film low ohm<br>W: Thick film low ohm low TCR<br>Q: Metal low ohm<br>M: Metal low ohm<br>R: Metal low ohm high power<br>N: Metal low ohm high power<br>P: Thick film low TCR high Power<br>2512 = 2W<br>2010 = 1W<br>1210 = 0.5W<br>1206 = 0.5W<br>C: Thick film Power low ohm up side down  | <b>Resistance</b><br>R followed by 3 significant digits<br>e.g. :<br>0.1Ω = R100<br>0.033Ω = R033<br>0.56Ω = R560   | <b>Tolerance</b><br>F : ± 1%<br>G : ± 2%<br>J : ± 5%  | <b>Packaging code</b><br>P : 4" reel taping<br>T : 7" reel taping<br>Q : 10" reel taping<br>G : 13" reel taping<br>R : 0603 2mm pitch taping<br>B : Bulk<br>K : Bulkcase  | <b>Termination code</b><br>L = Sn base (Lead free)<br>G = Au base<br>S = Ag base   |
| WF   | 12  | T   | 1001  | B   | T   | L  |
| <b>Type code</b><br>WF : Special function<br>MF : Special function AUTO<br>SF : Special function Anti-S<br>WK: Special function made in KM | <b>Size code</b><br>25 : 2512 (6432)<br>20 : 2010 (5025)<br>18 : 1218 (3248)<br>12 : 1206 (3216)<br>10 : 1210 (3225)<br>08 : 0805 (2012)<br>06 : 0603 (1608)<br>04 : 0402 (1005)  | <b>Functional code</b><br>G : High ohm (>10MΩ)<br>H : Thick film, High Precision <1%<br>K : Thick film, TCR50ppm<br>M : Trimmable<br>P : High Power<br>S : Surge<br>T : Thin film, TCR50ppm<br>U : Thin film, TCR25ppm<br>Q : Thin film, TCR50ppm, power<br>R : Thin film, TCR25ppm, power<br>F : Thin film TCR15ppm<br>W : Thin film TCR10ppm<br>Z : Thin film TCR 5ppm<br>V : High voltage<br>X : Special resistance<br>Y : E24/E96 resistance with special termination | <b>Resistance</b><br>E24(J tol.) : 2 significant digits followed by No. of zeros and a blank<br>e.g. : 3ohm = 3R0_<br>10ohm = 100_<br>220ohm = 221_<br>56Kohm = 563_<br>("_" means blank)<br>E24+E96 (F tol.) : 3 significant digits followed by No. of zeros<br>e.g. : 3Ω = 3R00<br>10Ω = 10R0<br>220Ω = 2200<br>56KΩ = 5602 | <b>Tolerance</b><br>A : ± 0.05%<br>B : ± 0.1%<br>C : ± 0.25%<br>D : ± 0.5%<br>F : ± 1%<br>G : ± 2%<br>J : ± 5%<br>K : ± 10%<br>L : ± 15%<br>M : ± 20%<br>P : Jumper<br>X : 0/-30%<br>Y : 0/-20%<br>Z : 0/-10%<br>Q : -0.8%~-1.0%<br>Y : +0.8%~+1.0%<br>Y : -10% ~ -9% | <b>Packaging code</b><br>P : 4" reel taping<br>T : 7" reel taping<br>Q : 10" reel taping<br>G : 13" reel taping<br>R : 0603 2mm pitch taping<br>B : Bulk<br>K : Bulkcase<br>D : 7" reel taping 20Kpcs<br>V : 7" reel taping 1Kpcs<br>A : 7" reel taping 15Kpcs  | <b>Termination code</b><br>L = Sn base (Lead free)<br>G = Au base<br>S = Ag base<br>C = Cu base<br>D = Cu base + Low profile |
| WA   | 04  | X   | 103_  | J   | T   | L  |
| <b>Type code</b><br>WA: Array<br>MA: Convex Array Auto<br>SA: Concave Array Anti-Sulfu   | <b>Size code</b><br>06 : 0603 (1608)<br>04 : 0402 (1005)<br>02 : 0201 (0603)  | <b>Functional code</b><br>X : *4, convex<br>Y : *2, convex<br>W : *8, convex<br>T : *4, concave<br>U : *2, concave<br>P : *3, convex (Attenuator)<br>A : *4, FLAT<br>B : *2, FLAT   | <b>Resistance</b><br>E24(J tol.) : 2 significant digits followed by No. of zeros and a blank<br>e.g. : 3ohm = 3R0_<br>10ohm = 100_<br>220ohm = 221_<br>56Kohm = 563_<br>("_" means blank)<br>E24+E96 (F tol.) : 3 significant digits followed by No. of zeros<br>e.g. : 3Ω = 3R00<br>10Ω = 10R0<br>220Ω = 2200<br>56KΩ = 5602 | <b>Tolerance</b><br>F : ± 1%<br>J : ± 5%<br>P : Jumper  | <b>Packaging code</b><br>T : 7" reel taping<br>A : 7" reel taping 15Kpcs<br>Q : 10" reel taping<br>G : 13" reel taping<br>B : Bulk<br>K : Bulkcase  | <b>Termination code</b><br>L = Sn base (Lead free)   |
| WT   | 04  | X   | 103   | J   | T   | L  |
| <b>Type code</b><br>T : Network Resistors  | <b>Size code</b><br>04 : total package size 1206 (3216)   | <b>Functional code</b><br>X : *8, convex  | <b>Resistance</b><br>E24(J tol.) : 2 significant digits followed by No. of zeros and a blank<br>e.g. : 3ohm = 3R0_<br>10ohm = 100_<br>220ohm = 221_<br>56Kohm = 563_<br>("_" means blank)   | <b>Tolerance</b><br>J : ± 5%<br>P : Jumper  | <b>Packaging code</b><br>T : 7" reel taping<br>B : Bulk   | <b>Termination code</b><br>L = Sn base (Lead free)   |

Remark :

1. Detail product part number, functional code, tolerance combination,..... please refer to specific data sheet.
2. Example : ("\_" means a blank)  
Chip-R 0805 size, 4.3ohm, 5%, Normal type, SnPb termination, 5000pcs taped in reel : WR08X4R3\_JTL
3. 1218 standard packing q'ty is 3Kpcs in 10" reel and packing code is T code



## Chip Resistor Selection Guide

### General Purpose Chip-R

| Series | Size         | Rated Power | TCR (ppm/°C)* | Tolerance | Resistance |
|--------|--------------|-------------|---------------|-----------|------------|
| WR25X  | 2512 (6432)  | 1W          | ±100          | ±1%       | 1 ~ 10MΩ   |
|        |              |             | ±200          | ±5%       |            |
| WR18X  | 1218 (3248)  | 1W          | ±100          | ±1%       |            |
|        |              |             | ±200          | ±5%       |            |
| WR20X  | 2010 (5025)  | 1/2W        | ±100          | ±1%       |            |
|        |              |             | ±200          | ±5%       |            |
| WR10X  | 1210 (3225)  | 1/3W        | ±100          | ±1%       |            |
|        |              |             | ±200          | ±5%       |            |
| WR12X  | 1206 (3216)  | 1/4W        | ±100          | ±1%       |            |
|        |              |             |               | ±5%       |            |
| WR08X  | 0805 (2012)  | 1/8W        | ±100          | ±1%       |            |
|        |              |             |               | ±5%       |            |
| WR06X  | 0603 (1608)  | 1/10W       | ±100          | ±1%       |            |
|        |              |             |               | ±5%       |            |
| WR04X  | 0402 (1005)  | 1/16W       | ±100          | ±1%       |            |
|        |              |             |               | ±5%       |            |
| WR02X  | 0201 (0603)  | 1/20W       | ±200          | ±1%       |            |
|        |              |             |               | ±5%       |            |
| WR01X  | 01005 (0402) | 1/32W       | ±200          | ±1%       | 4.7 ~ 1MΩ  |
|        |              |             |               | ±5%       |            |

- Remark:**
- Detailed resistance vs. TCR and ordering code please refer to specific specifications.
  - Jumper resistor is not designed for fusing applications, designers shall apply dedicate fusible resistor or standard fuse in application circuits.
  - WRxxW defines for ±1% < 10ohm or > 1Mohm.

### Thick Film Low Ohm Chip-R

| Series | Size        | Rated Power | TCR (ppm/°C) | Tolerance | Resistance      |
|--------|-------------|-------------|--------------|-----------|-----------------|
| WW25X  | 2512 (6432) | 1W          | ≤ 1500**     | ±1%       | 0.020Ω ~ 0.976Ω |
|        |             |             |              | ±5%       | 0.015Ω ~ 0.976Ω |
| WW18X  | 1218 (3248) | 1W          |              | ±1%       | 0.020Ω ~ 0.976Ω |
|        |             |             |              | ±5%       | 0.015Ω ~ 0.976Ω |
| WW20X  | 2010 (5025) | 1/2W        |              | ±1%       | 0.020Ω ~ 0.976Ω |
|        |             |             |              | ±5%       | 0.015Ω ~ 0.976Ω |
| WW10X  | 1210 (3225) | 1/3W        | ≤ 200        | ±1%       | 0.020Ω ~ 0.976Ω |
|        |             |             |              | ±5%       | 0.020Ω ~ 0.976Ω |
| WW12X  | 1206 (3216) | 1/4W        | ≤ 1500**     | ±1%       | 0.020Ω ~ 0.976Ω |
|        |             |             |              | ±5%       | 0.020Ω ~ 0.976Ω |
| WW08X  | 0805 (2012) | 1/8W        | ≤ 1500**     | ±1%       | 0.020Ω ~ 0.976Ω |
|        |             |             |              | ±5%       | 0.020Ω ~ 0.976Ω |
| WW06X  | 0603 (1608) | 1/10W       | ≤ 500**      | ±1%       | 0.100Ω ~ 0.976Ω |
|        |             |             |              | ±5%       | 0.100Ω ~ 0.976Ω |
| WW04X  | 0402 (1005) | 1/16W       | ≤ 600**      | ±1%       | 0.100Ω ~ 0.976Ω |
|        |             |             |              | ±5%       | 0.100Ω ~ 0.976Ω |

- Remark:**
- Detailed resistance vs. TCR and ordering code please refer to specific specifications.
  - Resistance value will be changed by soldering condition and design of soldering pad, please design products in consideration of this change.

### Thick Film Power Low Ohm Chip-R

| Series | Size        | Rated Power | TCR (ppm/°C)   | Tolerance | Resistance      |
|--------|-------------|-------------|--|-----------|-----------------|
| WW25P  | 2512 (6432) | 2W          | < 0.1Ω: 150ppm<br>≥ 0.1Ω: 100ppm                         | ±1%, ±5%  | 0.047Ω ~ 0.976Ω |
| WW20P  | 2010 (5025) | 1W          | < 0.1Ω: 150ppm<br>≥ 0.1Ω: 100ppm                         | ±1%, ±5%  | 0.047Ω ~ 0.976Ω |
| WW10P  | 1210 (3225) | 1/2W        | < 0.1Ω: 500ppm<br>≥ 0.1Ω: 200ppm                         | ±1%, ±5%  | 0.020Ω ~ 0.976Ω |
| WW12P  | 1206 (3216) | 1/2W        | < 0.1Ω: 200ppm<br>≥ 0.1Ω: 100ppm                         | ±1%, ±5%  | 0.047Ω ~ 0.976Ω |
| WW08P  | 0805 (2012) | 1/3W        | < 0.1Ω: 200ppm<br>≥ 0.1Ω: 150ppm                         | ±1%, ±5%  | 0.047Ω ~ 0.976Ω |
| WW06P  | 0603 (1608) | 1/4W        | < 0.1Ω: 250ppm<br>≥ 0.1Ω: 200ppm                         | ±1%, ±5%  | 0.047Ω ~ 0.976Ω |
| WW04P  | 0402 (1005) | 1/8W        | < 0.1Ω: 300ppm<br>≥ 0.1Ω: 200ppm                         | ±1%, ±5%  | 0.100Ω ~ 0.976Ω |
| WW12C  | 1206 (3216) | 1/2W        | < 0.02Ω: 150ppm<br>≥ 0.02Ω: 100ppm                       | ±1%, ±5%  | 0.015Ω ~ 0.100Ω |
| WW08C  | 0805 (2012) | 1/3W        | < 0.03Ω: 200ppm<br>≥ 0.03Ω: 100ppm                       | ±1%, ±5%  | 0.025Ω ~ 0.100Ω |
| WW06C  | 0603 (1608) | 1/4W        | < 0.051Ω: 0~+250ppm<br>≥ 0.051Ω: ±150ppm                 | ±1%, ±5%  | 0.020Ω ~ 0.100Ω |
| WW04C  | 0402 (1005) | 1/8W        | < 0.051Ω: 0~+350ppm<br>≥ 0.051Ω: ±150ppm                 | ±1%, ±5%  | 0.025Ω ~ 0.100Ω |
| WW02C  | 0201 (0603) | 1/10W       | < 0.033Ω: 500ppm<br>< 0.051Ω: 300ppm<br>≥ 0.051Ω: 100ppm | ±1%, ±5%  | 0.020Ω ~ 0.100Ω |

### Metal Low Ohm Sensing Type Chip-R

| Series | Size         | Rated Power | TCR (ppm/°C)* | Tolerance | Resistance  |
|--------|--------------|-------------|---------------|-----------|---|
| WW59M  | 5931 (15079) | 5W          | ±100          | ±1%, ±5%  | 2, 3, 5mΩ   |
| WW25N  | 2512 (6432)  | 2W          | ±100          | ±1%, ±5%  | 3, 5, 10, 15, 20, 25mΩ                              |
| WW25R  |              | 2W          | ±100          | ±1%, ±5%  | 1, 2, 3, 4, 5, 6, 7, 10mΩ                           |
| WW25M  |              | 1W          | ±100          | ±1%, ±5%  | 3, 5, 10, 15, 20, 25, 50mΩ                          |
| WW25Q  |              | 1W          | ±100          | ±1%, ±5%  | 1, 2, 3, 4, 5, 6, 7, 8, 9, 10, 11, 12, 13, 14, 15mΩ |
| WW20N  | 2010 (5025)  | 1W          | ±75           | ±1%, ±5%  | 5, 10, 15, 20mΩ                                     |
| WW12N  | 1206 (3216)  | 1W          | ±70           | ±1%, ±5%  | 5, 10, 15, 20, 25mΩ                                 |
| WW12R  |              | 1W          | ±100          | ±1%, ±5%  | 1 ~ 15mΩ  |
| WW12D  |              | 1W          | ±100          | ±1%, ±5%  | 20, 25, 30, 40, 50mΩ                                |
| WW08R  | 0805 (2012)  | 1/2W        | ±100          | ±1%, ±5%  | 4, 5, 10mΩ  |
| WW08D  | 0805 (2012)  | 1/2W        | ±100          | ±1%, ±5%  | 20, 25, 30, 40, 50mΩ                                |
| WW06R  | 0603 (1608)  | 1/3W        | ±100          | ±1%, ±5%  | 5, 10, 15mΩ   |

Remark: 1. Detailed resistance vs. TCR and ordering code please refer to specific specifications.  
2. Resistance value will be changed by soldering condition and design of soldering pad, please design products in consideration of this change.

### Chip Resistor Array

| Series | Size          | Rated Power | TCR (ppm/°C) | Termination | Tolerance | Resistance |
|--------|---------------|-------------|--------------|-------------|-----------|------------|
| WA06X  | 1206 (0603x4) | 1/10W       | ±200         | Convex      | ±1%, ±5%  | 10 ~ 1MΩ   |
| WA06T  | 1206 (0603x4) | 1/10W       | ±200         | Concave     | ±1%, ±5%  |            |
| WA06Y  | 0606 (0603x2) | 1/10W       | ±200         | Convex      | ±1%, ±5%  |            |
| WA04X  | 0804 (0402x4) | 1/16W       | ±200         | Convex      | ±1%, ±5%  |            |
| WA04T  | 0804 (0402x4) | 1/16W       | ±300         | Concave     | ±1%, ±5%  |            |
| WA04Y  | 0404 (0402x2) | 1/16W       | ±200         | Convex      | ±1%, ±5%  |            |
| WA04U  | 0404 (0402x2) | 1/16W       | ±300         | Concave     | ±1%, ±5%  | 10 ~ 100KΩ |
| WA06W  | 1606 (0402x8) | 1/16W       | ±200         | Convex      | ±1%, ±5%  |            |
| WA02Y  | 0806 (0201x2) | 1/32W       | ±300         | Convex      | ±1%, ±5%  |            |

Remark: 1. Detailed resistance vs. TCR and ordering code please refer to specific specifications.  
2. Resistance value will be changed by soldering condition and design of soldering pad, please design products in consideration of this change.

### Chip Attenuator

| Series | Size          | Type         | Termination | Tolerance      | Attenuation     | Impedance |
|--------|---------------|--------------|-------------|----------------|-----------------|-----------|
| WA04P  | 0404 (0402x2) | 4P3R, Π type | Convex      | ±0.1dB ~ 2.5dB | 0, 0.5dB ~ 20dB | 50Ω       |

### Chip Resistor Network

| Series | Size         | Rated Power | TCR (ppm/°C) | Termination | Tolerance | Resistance |
|--------|--------------|-------------|--------------|-------------|-----------|------------|
| WT04X  | 1206 (10P8R) | 1/16W       | ±200         | Convex      | ±5%       | 10 ~ 100KΩ |

### High Power Chip-R

| Series | Size        | Rated Power | TCR (ppm/°C) | Tolerance | Resistance      |
|--------|-------------|-------------|--------------|-----------|-----------------|
| WF25P  | 2512 (6432) | 2W          | ±100         | ±1%, ±5%  | Jumper; 1 ~ 1MΩ |
| WF20P  | 2010 (5025) | 1W          | ±100         |           |                 |
| WF10P  | 1210 (3225) | 1/2W        | ±100         |           |                 |
| WF12P  | 1206 (3216) | 1/2W        | ±100         |           |                 |
| WF08P  | 0805 (2012) | 1/4W        | ±100         |           |                 |
| WF06P  | 0603 (1608) | 1/8W        | ±100         |           |                 |
| WF04P  | 0402 (1005) | 1/8W        | ±100         |           |                 |

### Automotive Chip-R

| Series | Size        | Rated Power | TCR(ppm/°C) | Tolerance | Resistance |
|--------|-------------|-------------|-------------|-----------|------------|
| MR12   | 1206 (3216) | 1/4W        | ±200        | ±1%, ±5%  | 1~ 10MΩ    |
| MR08   | 0805 (2012) | 1/8W        | ±200        |           | 1~ 10MΩ    |
| MR06   | 0603 (1608) | 1/10W       | ±200        |           | 1~ 10MΩ    |
| MR04   | 0402 (1005) | 1/16W       | ±200        |           | 1~ 10MΩ    |

### Anti-Sulfuration Chip-R

| Series | Size        | Rated Power | TCR(ppm/°C) | Tolerance | Resistance |
|--------|-------------|-------------|-------------|-----------|------------|
| SR12   | 1206 (3216) | 1/4W        | ≤ 200       | ±1%, ±5%  | 1~ 10MΩ    |
| SR08   | 0805 (2012) | 1/8W        | ≤ 200       | ±1%, ±5%  | 1~ 10MΩ    |
| SR06   | 0603 (1608) | 1/10W       | ≤ 200       | ±1%, ±5%  | 1~ 10MΩ    |
| SR04   | 0402 (1005) | 1/16W       | ≤ 200       | ±1%, ±5%  | 1~ 10MΩ    |

### Surge Chip-R

| Series | Size        | Rated Power | TCR(ppm/°C) | Tolerance | Resistance  |
|--------|-------------|-------------|-------------|-----------|-------------|
| WK25S  | 2512 (6432) | 1W          | ≤ 200       | ±5%, ±10% | 0.27 ~ 22MΩ |
| WK20S  | 2010 (5025) | 3/4W        | ≤ 200       | ±5%, ±10% | 0.27 ~ 22MΩ |
| WK10S  | 1210 (3225) | 1/2W        | ≤ 200       | ±5%, ±10% | 0.27 ~ 22MΩ |
| WK12S  | 1206 (3216) | 1/4W        | ≤ 200       | ±5%, ±10% | 0.27 ~ 22MΩ |
| WK08S  | 0805 (2012) | 1/8W        | ≤ 200       | ±5%, ±10% | 0.27 ~ 22MΩ |

## High Voltage Chip-R

| Series | Size        | Rated Power | TCR(ppm/°C) | Voltage (V) | Tolerance       | Resistance  |
|--------|-------------|-------------|-------------|-------------|-----------------|-------------|
| WK25Z  | 2512 (6432) | 1W          | ≤ 200       | 2000        | ±5%, ±10%, ±20% | 4.7M ~ 16MΩ |
| WK20Z  | 2010 (5025) | 1/2W        | ≤ 200       | 1500        | ±5%, ±10%, ±20% | 1M ~ 16MΩ   |
| WK25V  | 2512 (6432) | 1W          | ≤ 200       | 800         | ±1%, ±5%        | 47~ 51MΩ    |
| WK20V  | 2010 (5025) | 1/2W        | ≤ 200       | 500         | ±1%, ±5%        | 47~ 51MΩ    |
| WK12V  | 1206 (3216) | 1/4W        | ≤ 200       | 500         | ±1%, ±5%        | 47~ 51MΩ    |
| WK08V  | 0805 (2012) | 1/8W        | ≤ 200       | 400         | ±1%, ±5%        | 47~ 51MΩ    |
| WK06V  | 0603 (1608) | 1/10W       | ≤ 200       | 200         | ±1%, ±5%        | 47~ 10MΩ    |

## Trimmable Chip-R

| Series | Size        | Rated Power | TCR(ppm/°C) | Tolerance      | Resistance |
|--------|-------------|-------------|-------------|----------------|------------|
| WK25M  | 2512 (6432) | 1W          | ≤ 200       | 0/-20%, 0/-30% | 1 ~ 4.7MΩ  |
| WK20M  | 2010 (5025) | 1/2W        | ≤ 200       | 0/-20%, 0/-30% | 1 ~ 4.7MΩ  |
| WK10M  | 1210 (3225) | 1/4W        | ≤ 200       | 0/-20%, 0/-30% | 1 ~ 4.7MΩ  |
| WK12M  | 1206 (3216) | 1/8W        | ≤ 200       | 0/-20%, 0/-30% | 1 ~ 4.7MΩ  |
| WK08M  | 0805 (2012) | 1/10W       | ≤ 200       | 0/-20%, 0/-30% | 1 ~ 4.7MΩ  |
| WK06M  | 0603 (1608) | 1/16W       | ≤ 100       | 0/-20%, 0/-30% | 10~ 4.7MΩ  |

## Total lead free Chip-R ( Pb < 100ppm )

| Series  | Size        | Rated Power | TCR(ppm/°C) | Tolerance | Resistance |
|---------|-------------|-------------|-------------|-----------|------------|
| WR12X_R | 1206 (3216) | 1/4W        | ≤ 200       | ±1%, ±5%  | 1~ 10MΩ    |
| WR08X_R | 0805 (2012) | 1/8W        | ≤ 200       | ±1%, ±5%  | 1~ 10MΩ    |
| WR06X_R | 0603 (1608) | 1/10W       | ≤ 200       | ±1%, ±5%  | 1~ 10MΩ    |
| WR04X_R | 0402 (1005) | 1/16W       | ≤ 200       | ±1%, ±5%  | 1~ 10MΩ    |
| WR02X_R | 0201 (0603) | 1/20W       | ≤ 200       | ±1%, ±5%  | 1~ 10MΩ    |
| WA04X_R | 0402X4      | 1/16W       | ≤ 200       | ±1%, ±5%  | 10 ~ 1MΩ   |
| WA04Y_R | 0402X2      | 1/16W       | ≤ 200       | ±1%, ±5%  | 10 ~ 1MΩ   |

## High Precision Chip-R

| Series | Size        | Rated Power | TCR(ppm/°C) | Tolerance                             | Resistance  |
|--------|-------------|-------------|-------------|---------------------------------------|-------------|
| WF10H  | 1210 (3225) | 1/3W        | ≤ 100       | ±0.1%, ±0.5%                          | 10 ~ 1MΩ    |
| WF12H  | 1206 (3216) | 1/4W        | ≤ 100       | ±0.1%, ±0.5%                          | 10 ~ 1MΩ    |
| WF08H  | 0805 (2012) | 1/8W        | ≤ 100       | ±0.1%, ±0.5%                          | 10 ~ 1MΩ    |
| WF06H  | 0603 (1608) | 1/10W       | ≤ 100       | ±0.1%, ±0.5%                          | 10 ~ 1MΩ    |
| WF04H  | 0402 (1005) | 1/16W       | ≤ 100       | ±0.1%, ±0.5%                          | 10 ~ 1MΩ    |
| WF25T  | 2512 (6432) | 3/4W        | ≤ 50        | ±0.05%, ±0.10%, ±0.25%, ±0.50%, ±1.0% | 10 ~ 1.5MΩ  |
| WF25Q  | 2512 (6432) | 1W          | ≤ 50        | ±0.05%, ±0.10%, ±0.25%, ±0.50%, ±1.0% | 10 ~ 1.5MΩ  |
| WF20T  | 2010 (5025) | 1/2W        | ≤ 50        | ±0.05%, ±0.10%, ±0.25%, ±0.50%, ±1.0% | 10 ~ 1.5MΩ  |
| WF20Q  | 2010 (5025) | 3/4W        | ≤ 50        | ±0.05%, ±0.10%, ±0.25%, ±0.50%, ±1.0% | 10 ~ 1.5MΩ  |
| WF10T  | 1210 (3225) | 1/4W        | ≤ 50        | ±0.05%, ±0.10%, ±0.25%, ±0.50%, ±1.0% | 10 ~ 1MΩ    |
| WF10Q  | 1210 (3225) | 2/5W        | ≤ 50        | ±0.05%, ±0.10%, ±0.25%, ±0.50%, ±1.0% | 10 ~ 1MΩ    |
| WF12T  | 1206 (3216) | 1/8W        | ≤ 50        | ±0.05%, ±0.10%, ±0.25%, ±0.50%, ±1.0% | 4.7 ~ 1MΩ   |
| WF12Q  | 1206 (3216) | 1/4W        | ≤ 50        | ±0.05%, ±0.10%, ±0.25%, ±0.50%, ±1.0% | 4.7 ~ 1MΩ   |
| WF08T  | 0805 (2012) | 1/10W       | ≤ 50        | ±0.05%, ±0.10%, ±0.25%, ±0.50%, ±1.0% | 4.7 ~ 1MΩ   |
| WF08Q  | 0805 (2012) | 1/8W        | ≤ 50        | ±0.05%, ±0.10%, ±0.25%, ±0.50%, ±1.0% | 4.7 ~ 1MΩ   |
| WF06T  | 0603 (1608) | 1/16W       | ≤ 50        | ±0.05%, ±0.10%, ±0.25%, ±0.50%, ±1.0% | 4.7 ~ 680KΩ |
| WF06Q  | 0603 (1608) | 1/10W       | ≤ 50        | ±0.05%, ±0.10%, ±0.25%, ±0.50%, ±1.0% | 4.7 ~ 680KΩ |
| WF04T  | 0402 (1005) | 1/16W       | ≤ 50        | ±0.05%, ±0.10%, ±0.25%, ±0.50%, ±1.0% | 10 ~ 100KΩ  |
| WF25U  | 2512 (6432) | 3/4W        | ≤ 25        | ±0.05%, ±0.10%, ±0.25%, ±0.50%, ±1.0% | 10 ~ 1.5MΩ  |
| WF25R  | 2512 (6432) | 1W          | ≤ 25        | ±0.05%, ±0.10%, ±0.25%, ±0.50%, ±1.0% | 10 ~ 1.5MΩ  |
| WF20U  | 2010 (5025) | 1/2W        | ≤ 25        | ±0.05%, ±0.10%, ±0.25%, ±0.50%, ±1.0% | 10 ~ 1.5MΩ  |
| WF20R  | 2010 (5025) | 3/4W        | ≤ 25        | ±0.05%, ±0.10%, ±0.25%, ±0.50%, ±1.0% | 10 ~ 1.5MΩ  |
| WF10U  | 1210 (3225) | 1/4W        | ≤ 25        | ±0.05%, ±0.10%, ±0.25%, ±0.50%, ±1.0% | 10 ~ 1MΩ    |
| WF10R  | 1210 (3225) | 2/5W        | ≤ 25        | ±0.05%, ±0.10%, ±0.25%, ±0.50%, ±1.0% | 10 ~ 1MΩ    |
| WF12U  | 1206 (3216) | 1/8W        | ≤ 25        | ±0.05%, ±0.10%, ±0.25%, ±0.50%, ±1.0% | 4.7 ~ 1MΩ   |
| WF12R  | 1206 (3216) | 1/4W        | ≤ 25        | ±0.05%, ±0.10%, ±0.25%, ±0.50%, ±1.0% | 4.7 ~ 1MΩ   |
| WF08U  | 0805 (2012) | 1/10W       | ≤ 25        | ±0.05%, ±0.10%, ±0.25%, ±0.50%, ±1.0% | 4.7 ~ 1MΩ   |
| WF08R  | 0805 (2012) | 1/8W        | ≤ 25        | ±0.05%, ±0.10%, ±0.25%, ±0.50%, ±1.0% | 4.7 ~ 1MΩ   |
| WF06U  | 0603 (1608) | 1/16W       | ≤ 25        | ±0.05%, ±0.10%, ±0.25%, ±0.50%, ±1.0% | 4.7 ~ 680KΩ |
| WF06R  | 0603 (1608) | 1/10W       | ≤ 25        | ±0.05%, ±0.10%, ±0.25%, ±0.50%, ±1.0% | 4.7 ~ 680KΩ |
| WF04U  | 0402 (1005) | 1/16W       | ≤ 25        | ±0.05%, ±0.10%, ±0.25%, ±0.50%, ±1.0% | 10 ~ 100KΩ  |
| WF12F  | 1206 (3216) | 1/8W        | ≤ 15        | ±0.05%, ±0.10%, ±0.25%                | 100 ~ 200KΩ |
| WF08F  | 0805 (2012) | 1/8W        | ≤ 15        | ±0.05%, ±0.10%, ±0.25%                | 100 ~ 200KΩ |
| WF06F  | 0603 (1608) | 1/10W       | ≤ 15        | ±0.05%, ±0.10%, ±0.25%                | 100 ~ 100KΩ |
| WF04F  | 0402 (1005) | 1/16W       | ≤ 15        | ±0.05%, ±0.10%, ±0.25%                | 100 ~ 20KΩ  |
| WF12W  | 1206 (3216) | 1/8W        | ≤ 10        | ±0.05%, ±0.10%, ±0.25%                | 25 ~ 300KΩ  |
| WF08W  | 0805 (2012) | 1/8W        | ≤ 10        | ±0.05%, ±0.10%, ±0.25%                | 25 ~ 200KΩ  |
| WF06W  | 0603 (1608) | 1/10W       | ≤ 10        | ±0.05%, ±0.10%, ±0.25%                | 25 ~ 100KΩ  |
| WF04W  | 0402 (1005) | 1/16W       | ≤ 10        | ±0.05%, ±0.10%, ±0.25%                | 25 ~ 20KΩ   |
| WF12Z  | 1206 (3216) | 1/8W        | ≤ 5         | ±0.05%, ±0.10%, ±0.25%                | 25 ~ 120KΩ  |
| WF08Z  | 0805 (2012) | 1/8W        | ≤ 5         | ±0.05%, ±0.10%, ±0.25%                | 25 ~ 80KΩ   |
| WF06Z  | 0603 (1608) | 1/10W       | ≤ 5         | ±0.05%, ±0.10%, ±0.25%                | 25 ~ 40KΩ   |
| WF04Z  | 0402 (1005) | 1/16W       | ≤ 5         | ±0.05%, ±0.10%, ±0.25%                | 25 ~ 8KΩ    |

## General Purpose Chip Resistors (1Ω~10MΩ)

### Feature

1. High reliability and stability
2. Reduced size of final equipment
3. Lower assembly costs
4. Higher component and equipment reliability
5. RoHs compliant and lead free products

### Application

1. Consumer electrical equipment, PDA Digital Camcorder,
2. EDP, Computer application
3. Mobile phone, Telecom
4. Power supply, Battery charger, DC-DC power converter
5. Digital meter
6. Automotive.

### Description

The resistors are constructed in a high grade ceramic body (aluminum oxide). Internal metal electrodes are added at each end and connected by a resistive paste that is applied to the top surface of the substrate. The composition of the paste is adjusted to give the approximate resistance required and the value is trimmed to within tolerance by laser cutting of this resistive layer.

The resistive layer is covered with a protective coat. Finally, the two external end terminations are added. For ease of soldering the outer layer of these end terminations is Tin solder (Pb free) alloy.



### Quick Reference Data

| Series No.   | WR25X  | WR20X          | WR18X                   | WR10X          | WR12X                   | WR08X          | WR06X          | WR04X          | WR02X          | WR01X           |
|--|--|----------------|-------------------------|----------------|-------------------------|----------------|----------------|----------------|----------------|-----------------|
| Size code  | 2512<br>(6432)                                       | 2010<br>(5025) | 1218<br>(3248)          | 1210<br>(3225) | 1206<br>(3216)          | 0805<br>(2012) | 0603<br>(1608) | 0402<br>(1005) | 0201<br>(0603) | 01005<br>(0402) |
| Resistance Range<br>±5% Tolerance (E24)<br>±1% Tolerance (E24+E96) | ±5% (E24): 1Ω~10MΩ; Jumper<br>±1% (E2+E964): 1Ω~10MΩ |                |                         |                |                         |                |                |                |                |                 |
| TCR (ppm/°C)<br>R>1MΩ<br>1MΩ≥R>10Ω<br>R≤10Ω                        | ≤±200<br>≤±100<br>≤±200                              |                | ≤±200<br>≤±100<br>≤±200 |                | ≤±100<br>≤±100<br>≤±200 |                |                | ≤±200<br>≤±300 |                | ≤±200<br>≤±300  |
| Max. dissipation @ Tamb=70°C                                       | 1.0 W  | 1/2 W          | 1.0 W                   | 1/3 W          | 1/4 W                   | 1/8 W          | 1/10 W         | 1/16 W         | 1/20 W         | 1/32 W          |
| Max. Operation Voltage<br>(DC or RMS)                              | 250V   | 200V           | 200V                    | 200V           | 200V                    | 150V           | 50V            | 50V            | 25V            | 20V             |
| Operation Temperature  | -55 ~ +155   |                |                         |                |                         |                |                |                | -55 ~ +125     |                 |
| Basic Specification  | JIS C 5201-1 / IEC 60115-1                           |                |                         |                |                         |                |                |                |                |                 |

Note:

1. This is the maximum voltage that may be continuously supplied to the resistor element, see "IEC publication 60115-8".
2. Max. Operation Voltage: So called RCWW (Rated Continuous Working Voltage) is determined by  
 $RCWW = \sqrt{\text{Rated Power} \times \text{Resistance Value}}$  or Max. RCWW listed above, whichever is lower.
3. Detailed TCR please refer to specific specification.

### Physical Dimensions

Unit: mm

| Size | 2512<br>(6432) | 2010<br>(5025) | 1218<br>(3248) | 1210<br>(3225) | 1206<br>(3216) | 0805<br>(2012) | 0603<br>(1608) | 0402<br>(1005) | 0201<br>(0603) | 01005<br>(0402) |
|------|----------------|----------------|----------------|----------------|----------------|----------------|----------------|----------------|----------------|-----------------|
| L    | 6.40±0.20      | 5.00±0.20      | 3.05±0.15      | 3.10±0.10      | 3.10±0.10      | 2.00±0.10      | 1.60±0.10      | 1.00±0.05      | 0.60±0.03      | 0.40±0.02       |
| W    | 3.20±0.20      | 2.50±0.20      | 4.60±0.20      | 2.60±0.10      | 1.60±0.10      | 1.25±0.10      | 0.80±0.10      | 0.50±0.05      | 0.30±0.03      | 0.20±0.02       |
| T    | 0.60±0.10      | 0.55±0.10      | 0.55±0.10      | 0.55±0.10      | 0.60±0.15      | 0.50±0.15      | 0.45±0.15      | 0.35±0.05      | 0.23±0.03      | 0.13±0.02       |
| Tb   | 0.90±0.25      | 0.60±0.25      | 0.50±0.25      | 0.50±0.20      | 0.45±0.20      | 0.40±0.20      | 0.30±0.15      | 0.25±0.10      | 0.15±0.05      | 0.10±0.03       |
| Tt   | 0.65±0.25      | 0.65±0.25      | 0.45±0.25      | 0.50±0.20      | 0.50±0.20      | 0.40±0.20      | 0.30±0.10      | 0.20±0.10      | 0.50±0.20      | 0.08±0.03       |

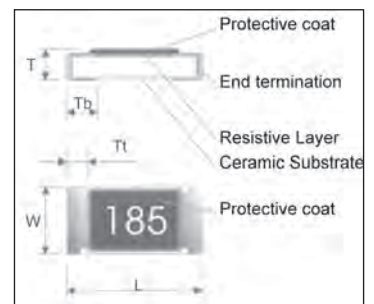

### Power Deration Curve

For resistors operated in ambient temperature over 70°C, power rating should be derated in accordance with the following figures.

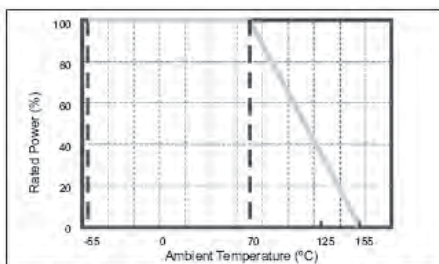

For Climatic category (IEC 60068) 55/155/56

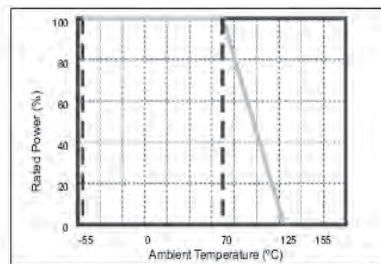

For Climatic category (IEC 60068) 55/125/56 (for 0201 type)



## Thick Film Low Ohm/Power Low Ohm Chip Resistors

### Function For Low Ohm Chip Resistors

The low ohmic resistors are used to sense output current in power supply, automotive and engine control management system, and other power sensing application. As shows in figure below, the typical function of low ohmic (power) chip resistor is to be a current sensor ( $R_{sense}$ ) to generate the sensing voltage ( $V_s$ ) for the purpose of feedback control when output current ( $I_o$ ) passed on it. The sensing voltage be treated as a signal to trigger the switches (CMOS) ON/OFF duration so that to monitor and/or adjust the output current from inductor.

Simplify to say,  $V_s = I_o \times R_{sense}$ .

In general case, this feedback voltage is setting around 100mV for considering both on power saving and noise robustness. To sense a 5 ampere average output current, the  $R_{sense}$  resistance value therefore be required as  $100mV / 5A = 20 m\Omega$ , the power dissipation will be :

$$P = I^2 \times R = 5A^2 \times 20m\Omega = 0.5Watt$$

A low ohmic chip resistor with a power rating of 1.0 watt is recommended on this application in case the power safety margin is taken into account.

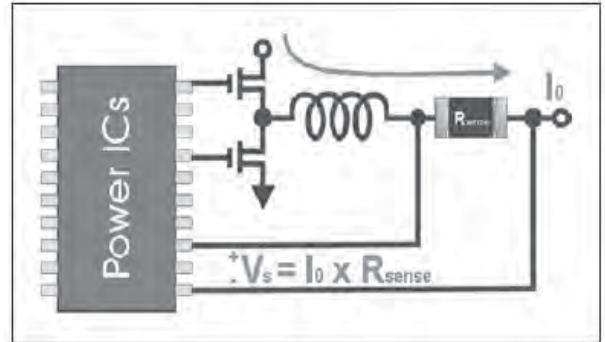

### Quick Reference Data of Low Ohm Chip Resistor

| Series No.                         | WW25X   | WW20X          | WW18X          | WW10X          | WW12X          | WW08X           | WW06X          | WW04X          |
|------------------------------------|---|----------------|----------------|----------------|----------------|-----------------|----------------|----------------|
| Size code                          | 2512<br>(6432)                                    | 2010<br>(5025) | 1218<br>(3248) | 1210<br>(3225) | 1206<br>(3216) | 0805<br>(2012)  | 0603<br>(1608) | 0402<br>(1005) |
| Resistance Tolerance               | ±5% , ±1%   |                |                |                |                |                 |                |                |
| Resistance Range                   | 0.020Ω ~ 0.976Ω                                   |                |                |                |                | 0.100Ω ~ 0.976Ω |                |                |
| TCR (ppm/°C)                       | Detailed TCR please refer to specific data sheets |                |                |                |                |                 |                |                |
| Max. dissipation @ Tamb=70°C       | 1 Watt  | 0.5 Watt       | 1 Watt         | 1/3 Watt       | 1/4 Watt       | 1/8 Watt        | 1/10 Watt      | 1/16 Watt      |
| Max. Operation Voltage (DC or RMS) | 250V  | 200V           | 200V           | 200V           | 200V           | 100V            | 50V            | 50V            |
| Operation Temperature              | -55 ~ +155  |                |                |                |                |                 |                |                |
| Basic Specification                | JIS C 5201-1 / IEC 60115-1                        |                |                |                |                |                 |                |                |

Note :

1. This is the maximum voltage that may be continuously supplied to the resistor element, see "IEC publication 60115-9".
2. Power derating curve, and detail specification please refer to specific data sheets.
3. Resistance value will be changed by soldering condition and design of soldering pad, please design products in consideration of change of resistance value.

### Quick Reference Data of Power Low Ohm Chip Resistor

| Item                               | General Specification |             |             |            |            |              |
|------------------------------------|-----------------------|-------------|-------------|------------|------------|--------------|
| Series No.                         | WW25P                 | WW20P       | WW12P       | WW08P      | WW06P      | WW04P        |
| Size code                          | 2512 (6432)           | 2010 (5025) | 1206 (3216) | 0805(2012) | 0603(1608) | 0402(1005)   |
| Resistance Tolerance               | ±5% , ±1%             |             |             |            |            |              |
| Resistance Range                   | 0.047Ω ~ 0.976Ω       |             |             |            |            | 0.1Ω~0.976Ω  |
| TCR (ppm/°C) < 0.100Ω              | ±150ppm/°C            | ±150ppm/°C  | ±200ppm/°C  | ±200ppm/°C | ±250ppm/°C | -            |
| ≥ 0.100Ω                           | ±100ppm/°C            | ±100ppm/°C  | ±100ppm/°C  | ±150ppm/°C | ±200ppm/°C | 0~+300ppm/°C |
| Max. dissipation @ Tamb=70°C       | 2 W                   | 1 W         | 1/2 W       | 1/3 W      | 1/4 W      | 1/8 W        |
| Max. Operation Voltage (DC or RMS) | 300V                  | 200V        | 200V        | 150V       | 50V        | 50V          |
| Operation Temperature              | -55 ~ +155            |             |             |            |            |              |

Note :

1. This is the maximum voltage that may be continuously supplied to the resistor element, see "IEC publication 60115-8".
2. Max. Operation Voltage : So called RCWW (Rated Continuous Working Voltage) is determined by  $RCWV = \sqrt{\text{Rater Power} \times \text{Resistance Value}}$  or Max. RCWV listed above, whichever is lower.
3. 2W loading with total solder-pad and trace size of 300mm<sup>2</sup>

### Physical Dimensions

Unit: mm

| Dimensions | WW25P     | WW20P     | WW12P     | WW08P     | WW06P     | WW04P          |
|------------|-----------|-----------|-----------|-----------|-----------|----------------|
| L          | 6.30±0.20 | 5.00±0.20 | 3.10±0.15 | 2.00±0.15 | 1.60±0.10 | 1.00±0.05      |
| W          | 3.10±0.20 | 2.50±0.20 | 1.60±0.15 | 1.20±0.15 | 0.80±0.10 | 0.50±0.05      |
| T          | 0.60±0.15 | 0.60±0.10 | 0.55±0.10 | 0.50±0.10 | 0.45±0.10 | 0.35±0.05      |
| Tt         | 0.60±0.25 | 0.60±0.25 | 0.50±0.25 | 0.40±0.20 | 0.30±0.20 | 0.20±0.10      |
| Tb         | 1.80±0.25 | 0.65±0.25 | 0.50±0.25 | 0.40±0.20 | 0.30±0.20 | 0.25+0.05/-0.1 |

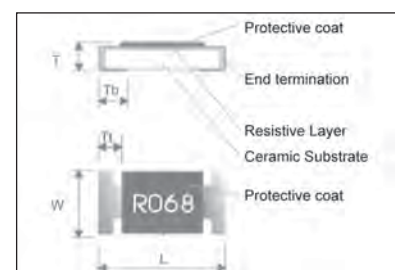

## ■ Metal Low Ohm Sensing Chip Resistors (0.001Ω~ 0.050Ω)

### ■ Description

The resistors are constructed in a high grade low resistive metal body. The resistive layer is covered with a protective coat and printed a resistance marking code over it. Finally, the two external end terminations are added. For ease of soldering the outer layer of these end terminations is a lead free terminations.

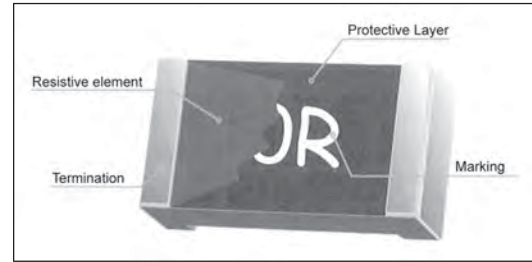

### ■ Quick Reference Data

| Item                               | General Specification |          |                         |                      |                      |             |
|------------------------------------|-----------------------|----------|-------------------------|----------------------|----------------------|-------------|
| Series No.                         | WW25R                 | WW25Q    | WW12R                   | WW12D                | WW08D                | WW06R       |
| Size code                          | 2512 (6432)           |          | 1206(3216)              |                      | 0805 (2012)          | 0603 (1608) |
| Resistance Tolerance               | ±5% , ±1%             |          |                         |                      |                      |             |
| Resistance Range                   | 1,2,3,4,5,6,7,10mΩ    | 1 ~ 15mΩ | 1, 4, 5, 6, 8, 10, 15mΩ | 20, 25, 30, 40, 50mΩ | 20, 25, 30, 40, 50mΩ | 5, 10, 15mΩ |
| TCR (ppm/°C)                       | ±100ppm               |          | ±100ppm                 |                      | ±100ppm              | ±100ppm     |
| Max. dissipation @ Tamb=70°C       | 2 W                   | 1 W      | 1 W                     | 1 W                  | 1/2 W                | 1/3 W       |
| Max. Operation Current (DC or RMS) | 44.7A                 |          | 14A                     |                      | 5A                   | 8.1A        |
| Operation Temperature              | -55 ~ +155            |          |                         |                      |                      |             |

| Item                               | General Specification              |                        |                 |       |                     |       |
|------------------------------------|------------------------------------|------------------------|-----------------|-------|---------------------|-------|
| Series No.                         | WW25M                              | WW25N                  | WW20M           | WW20N | WW12N               | WW12M |
| Size code                          | 2512 (6432)                        |                        | 2010 (5025)     |       | 1206(3216)          |       |
| Resistance Tolerance               | ±5% , ±1%                          |                        |                 |       |                     |       |
| Resistance Range                   | 1~10, 12, 15, 20, 25, 30, 40, 50mΩ | 1~10, 12, 15, 20, 25mΩ | 5, 10, 15, 20mΩ |       | 5, 10, 15, 20, 25mΩ |       |
| TCR (ppm/°C)                       | 1-4mΩ: ±100ppm; > 4m: ± 75 ppm/°C  |                        | ± 75 ppm/°C     |       | ± 70 ppm/°C         |       |
| Max. dissipation @ Tamb=70°C       | 1 W                                | 2 W                    | 1/2 W           | 1 W   | 1 W                 | 1/2 W |
| Max. Operation Voltage (DC or RMS) | 250V                               |                        | 250V            |       | 200V                |       |
| Max. Overload Voltage (DC or RMS)  | 500V                               |                        | 500V            |       | 400V                |       |
| Operation Temperature              | -55 ~ +155                         |                        |                 |       |                     |       |

Note :

1. This is the maximum voltage that may be continuously supplied to the resistor element, see "IEC publication 60115-8".
2. Power derating curve, and detail specification please refer to specific data sheets.
3. Resistance value will be changed by soldering condition and design of soldering pad, please design products in consideration of change of resistance value.

### ■ Physical Dimensions:

WW25M(0.002Ω~0.025Ω), WW25N(0.003Ω~0.025Ω), WW20N, WW12N

Unit: mm

| Symbol | 2512      | 2010      | 1206      |
|--------|-----------|-----------|-----------|
| L      | 6.40±0.20 | 5.00±0.20 | 3.10±0.20 |
| W      | 3.20±0.20 | 2.50±0.20 | 1.60±0.20 |
| T      | 0.60±0.15 | 0.60±0.15 | 0.60±0.25 |
| Tt     | 0.65±0.25 | 0.65±0.25 | 0.60±0.20 |
| Tb     | 0.65±0.25 | 0.65±0.25 | 0.60±0.20 |

WW25M(0.001Ω), WW25N(0.001Ω~0.002Ω)

Unit: mm

| Symbol | 2512      |
|--------|-----------|
| L      | 6.40±0.20 |
| W      | 3.20±0.20 |
| T      | 0.60±0.10 |
| Tt     | 1.60±0.25 |
| Tb     | 1.60±0.25 |

WW25Q, WW25R, WW12R, WW12D, WW06R

Note : 1. The detailed dimensions please refer to data sheet per type!

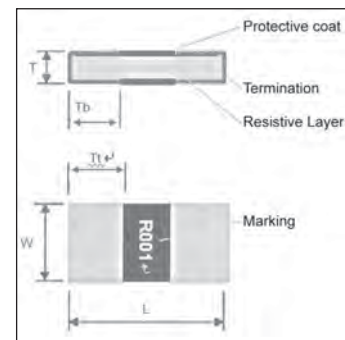
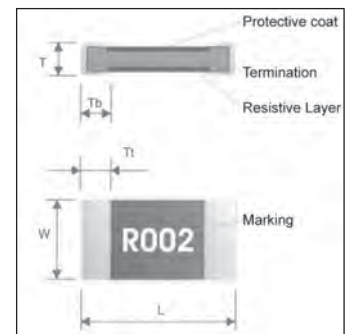

## Chip Resistors Array : Convex Termination

### Feature

1. High reliability and stability
2. Reduced size of final equipment
3. Lower assembly cost and higher surface mounted efficiency
4. Higher component and equipment reliability

### Application

1. Consumer electrical equipment, PDA Digital Camcorder,
2. EDP, Computer application
3. Mobile phone, Telecom
4. DIMM

### Description and Physical Dimensions

The resistors array is constructed in a high grade ceramic body (aluminum oxide). Internal metal electrodes are added at each end and connected by a resistive paste that is applied to the top surface of the substrate. The composition of the paste is adjusted to give the approximate resistance required and the value is trimmed to within tolerance by laser cutting of this resistive layer.

The resistive layer is covered with a protective coat. Finally, the two external end terminations are added. For ease of soldering the outer layer of these end termination is Tin solder alloy. Marking code description is depended on component size and tolerance. Following figure shown the construction of a Chip-R array.

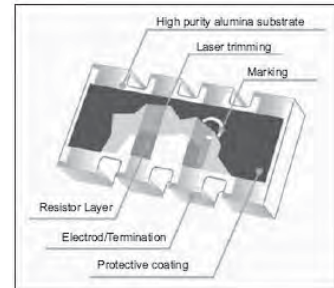

### Physical Dimensions

Unit: mm

| Type | WA06X     | WA04X     | WA06Y     | WA04Y     |
|------|-----------|-----------|-----------|-----------|
| L    | 3.20±0.10 | 2.00±0.10 | 1.60±0.10 | 1.00±0.10 |
| W    | 1.60±0.10 | 1.00±0.10 | 1.50±0.10 | 1.00±0.10 |
| T    | 0.50±0.10 | 0.45±0.10 | 0.50±0.10 | 0.35±0.10 |
| P    | 0.80±0.10 | 0.50±0.05 | 1.00±0.10 | 0.65±0.10 |
| A    | 0.60±0.10 | 0.40±0.10 | 0.60±0.10 | 0.34±0.10 |
| B    | 0.30±0.10 | 0.20±0.10 | 0.30±0.15 | 0.20±0.15 |
| C    | 0.40±0.10 | 0.30±0.05 | -         | -         |
| G    | 0.30±0.20 | 0.25±0.10 | 0.30±0.15 | 0.25±0.17 |

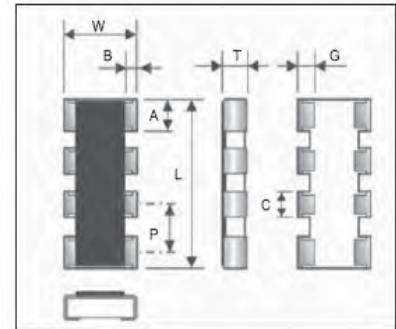

### Quick Reference Data

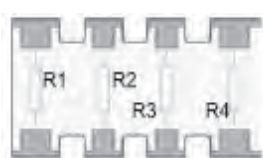
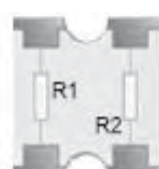
| Series No.                         | WA06X   | WA04X          | WA06Y   | WA04Y          |
|------------------------------------|---|----------------|---|----------------|
| Size                               | 0603×4(1608×4)  | 0402×4(1005×4) | 0603×2(1608×4)  | 0402×2(1005×2) |
| Termination construction           | 8P4R, Convex  |                | 4P2R, Convex  |                |
| Resistance Tolerance               | ±5%, ±1% (E24 series)   |                |   |                |
| Resistance Range                   | 10Ω~1MΩ(E24 series), Jumper (0Ω)  |                |   |                |
| TCR (ppm/°C)                       | ±200 ppm/°C   |                |   |                |
| Max. dissipation @ Tamb=70°C       | 1/10 Watt   | 1/16 Watt      | 1/10 Watt   | 1/16 Watt      |
| Max. Operation Voltage (DC or RMS) | 50V   | 50V            | 1/10 Watt   | 1/16 Watt      |
| Max. Overload Voltage (DC or RMS)  | 100V  | 100V           | 1/10 Watt   | 1/16 Watt      |
| Operation Temperature              | -55 ~ +155  |                |   |                |
| Basic Specification                | JIS C5201-1 / IEC 60115-1   |                |   |                |
| Circuit Mode: R1=R2(=R3=R4)        |  |                |  |                |

Note :  
Power derating curve and detail specification please refer to specific data sheets.

## WA06W Chip Resistors Array 16P8R

### Description

The resistors array is constructed in a high grade ceramic body (aluminum oxide). Internal metal electrodes are added at each end and connected by a resistive paste that is applied to the top surface of the substrate. The composition of the paste is adjusted to give the approximate resistance required and the value is trimmed to within tolerance by laser cutting of this resistive layer.

The resistors layer is covered with a protective coat. Finally, the two external end terminations are added. For ease of soldering the outer layer of these end termination is Tin (Pb free) solder alloy.

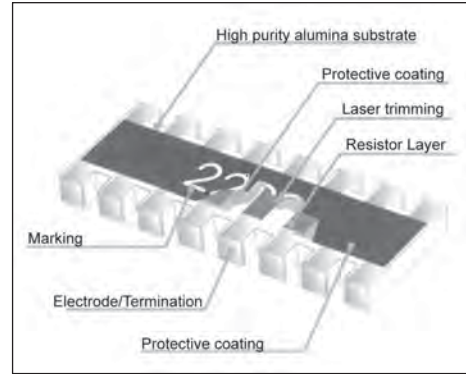

### Quick Reference Data

| Item                                     | General Specification  |                        |
|--|------------------------|------------------------|
| Series No.                               | WA06W                  | WA06W_N                |
| Size                                     | 1606 (0602×8)          | 1606 (0602×8)          |
| Termination construction                 | Convex type            | Convex type            |
| Resistance Tolerance                     | ±5% (E24 series)       | ±5% (E24 series)       |
| Resistance Range                         | 10Ω~100KΩ, Jumper (0Ω) | 10Ω~100KΩ, Jumper (0Ω) |
| TCR (ppm/°C)                             | ± 200 ppm/°C           | ± 200 ppm/°C           |
| Max. dissipation @ Tamb=70°C             | 1/16 W                 | 1/16 W                 |
| Max. Operation Voltage (DC or RMS)       | 50V                    | 25V                    |
| Max. Overload Voltage (DC or RMS)        | 100V                   | 50V                    |
| Carrier Tape width                       | 12mm                   | 8mm                    |
| Operation Temperature                    | -55 ~ +155             |                        |
| Circuit Mode:<br>R1=R2=R3=R4=R5=R6=R7=R8 |                        |                        |

Note :  
Power derating curve and detail specification please refer to specific data sheets.

### Physical Dimensions:

Unit: mm

| Symbol | WA06W     | WA06W_N   |
|--------|-----------|-----------|
| L      | 4.00±0.20 | 3.80±0.10 |
| W      | 1.60±0.15 | 1.60±0.10 |
| T      | 0.45±0.10 | 0.45±0.10 |
| B      | 0.30±0.20 | 0.30±0.10 |
| G      | 0.30±0.20 | 0.30±0.10 |
| D      | 0.20±0.10 | 0.20±0.10 |
| P      | 0.50±0.20 | 0.50±0.10 |
| H1     | 0.40±0.20 | 0.30±0.10 |
| H2     | 0.30±0.10 | 0.30±0.10 |

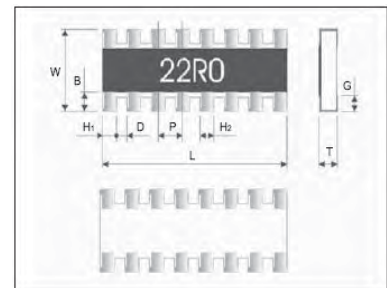



## Chip Resistors Array : Concave Termination

### Feature

1. High reliability and stability
2. Reduced size of final equipment
3. Lower assembly cost and higher surface mounted efficiency
4. Higher component and equipment reliability
5. Strong body and terminations
6. Excellent performance in surface mounting assembly.

### Description and Physical Dimensions

The resistor array is constructed in a high grade ceramic body (aluminum oxide). Internal metal electrodes are added at each end and connected by a resistive paste that is applied to the top surface of the substrate. The composition of the paste is adjusted to give the approximate resistance required and the value is trimmed to within tolerance by laser cutting of this resistive layer.



The resistive layer is covered with a protective coat. Finally, the two external end terminations are added. For ease of soldering the outer layer of these end termination is Tin solder alloy. Marking code description is depended on component size and tolerance. Following figure shown the construction of a Chip-R array.

### Application

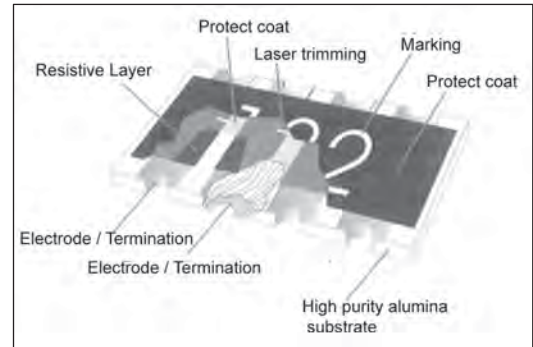
1. Consumer electrical equipment, PDA Digital Camcorder,
2. EDP, Computer application
3. Mobile phone, Telecom
4. DIMM

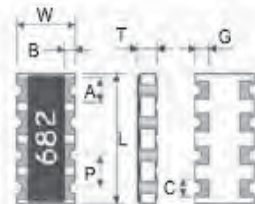

### Quick Reference Data

| Item  | General Specification  |                   |  |             |
|---|--|-------------------|--|-------------|
| Series No.  | WA06T  | WA04T             | WA04U  |             |
| Size  | 0603×4 (1608×4)  | 0402×4 (1005×4)   | 0402×2 (1005×2)  |             |
| Termination construction  | Concave type   |                   |  |             |
| Resistance Tolerance  | ±5% , ±1% (E24 series)   |                   |  |             |
| Resistance Range  | 10Ω~1MΩ, Jumper (0Ω)   |                   |  |             |
| TCR (ppm/°C)  | ± 200 ppm/°C   | ± 300 ppm/°C      | ± 300 ppm/°C   |             |
| Max. dissipation @ Tamb=70°C  | 1/10 W   | 1/16 W            | 1/16 W   |             |
| Max. Operation Voltage (DC or RMS)  | 50V  | 25V               | 25V  |             |
| Max. Overload Voltage   | 100V   | 50V               | 50V  |             |
| Operation Temperature   | -55 ~ +155   |                   |  |             |
| Circuit Mode  | <br>R1=R2=R3=R4 |                   | <br>R1 = R2 |             |
|  | L  | 3.20+0.20/-0.10mm | 2.00±0.10mm  | 1.00±0.10mm |
|   | W  | 1.60+0.20/-0.10mm | 1.00±0.10mm  | 1.00±0.10mm |
|   | T  | 0.60±0.20mm       | 0.45±0.10mm  | 0.30±0.10mm |
|   | P  | 0.80±0.10mm       | 0.50±0.05mm  | 0.50±0.05mm |
|   | A  | 0.60±0.15mm       | 0.35±0.05mm  | 0.35±0.10mm |
|   | B  | 0.35±0.15mm       | 0.20±0.15mm  | 0.25±0.15mm |
|   | C  | 0.50±0.15mm       | 0.25±0.05mm  | 0.35±0.10mm |
|   | G  | 0.50±0.15mm       | 0.25±0.15mm  | 0.25±0.15mm |

Note :

1. Power derating curve and detail specification please refer to specific data sheets.
2. Max. Operation Voltage : So called RCWW (Rated Continuous Working Voltage) is determined by  $RCWW = \sqrt{\text{Rated Power} \times \text{Resistance Value}}$  or Max. RCWW listed above, whichever is lower.

## WT04X Chip Resistor Network 10P8R

### Description

The resistor array is constructed in a high grade ceramic body (aluminum oxide). Internal metal electrodes are added at each end and connected by a resistive paste that is applied to the top surface of the substrate. The composition of the paste is adjusted to give the approximate resistance required and the value is trimmed to within tolerance by laser cutting of this resistive layer.

The resistive layer is covered with a protective coat. Finally, the two external end terminations are added. For ease of soldering the outer layer of these end termination is Tin (Pb free) solder alloy.

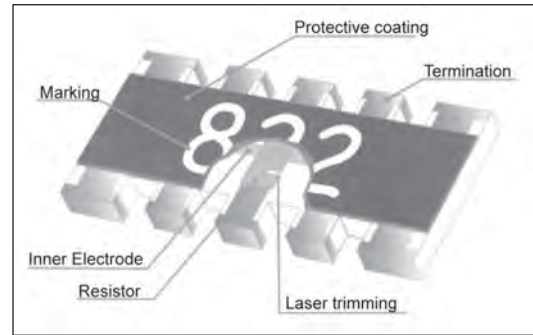

### Quick Reference Data

| Item   | General Specification |
|--|-----------------------|
| Series No.   | WT04X                 |
| Size   | 0402x8 (1005x8)       |
| Termination construction   | Convex type           |
| Resistance Tolerance   | ±5% (E24 series)      |
| Resistance Range   | 10Ω ~ 100KΩ           |
| TCR (ppm/°C)   | ± 200 ppm/°C          |
| Max. dissipation @ Tamb=70°C   | 1/16 W                |
| Max. Operation Voltage (DC or RMS)   | 25V                   |
| Max. Overload Voltage (DC or RMS)  | 50V                   |
| Operation Temperature  | -55 ~ +155            |
| Circuit Mode:<br>Resistor elements on pin1 ~ pin4, pin6 ~ pin9;<br>R1=R2=R3=R4=R6=R7=R8=R9 |                       |

Note :  
1. Power derating curve and detail specification please refer to specific data sheets.

### Physical Dimensions:

Unit: mm

| Symbol |           |
|--------|-----------|
| L      | 3.30±0.20 |
| W      | 1.60±0.15 |
| T      | 0.55±0.10 |
| P      | 0.64±0.05 |
| A      | 0.50±0.05 |
| B      | 0.40±0.15 |
| C      | 0.40±0.15 |
| G      | 0.40±0.15 |

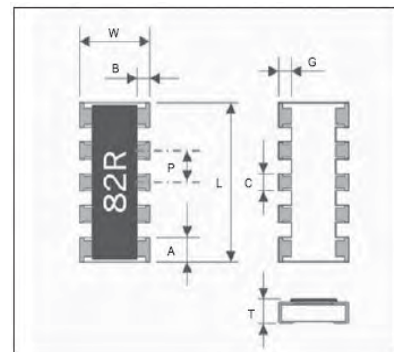

## WA04P Chip Attenuator

### Typical Application of Chip Attenuator

| WA04                      | P                                   | 001  | X                               | B  | T                  | L                        |
|---------------------------|-------------------------------------|--|---------------------------------|--|--------------------|--------------------------|
| <b>Size code</b>          | <b>Type code</b>                    | <b>Attenuation Range</b>   | <b>Characteristic Impedance</b> | <b>Attenuation Tolerance</b>   | <b>Termination</b> | <b>Packaging</b>         |
| WA04: 0402<br>per element | P: convex, $\pi$ type<br>attenuator | 000 = 0dB<br>R05 = 0.5dB<br>001 = 1dB<br>R15 = 1,5dB<br>002 = 2dB<br>003 = 3dB<br>004 = 4dB<br>005 = 5dB<br>006 = 6dB<br>007 = 7dB<br>008 = 8dB<br>009 = 9dB<br>010 = 10dB<br>011 = 11dB<br>012 = 12dB<br>013 = 13dB<br>014 = 14dB<br>015 = 15dB<br>016 = 16dB<br>017 = 17dB<br>018 = 18dB<br>019 = 19dB<br>020 = 20dB | X:50 $\Omega$                   | A: $\pm 0.1$ dB<br>B: $\pm 0.3$ dB<br>C: $\pm 0.4$ dB<br>D: $\pm 0.8$ dB<br>E: $\pm 1.0$ dB<br>F: $\pm 1.5$ dB<br>G: $\pm 2.0$ dB<br>H: $\pm 2.5$ dB<br>P: - | T=7" reel taped    | L=Sn base<br>(lead free) |

$\pi$  type Attenuator (-6dB, 50W) for VSWR improvement and output frequency level matching on VCO application.

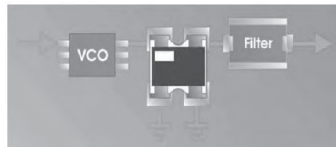

### Quick Reference Data

| Item                                | General Specification             |
|-------------------------------------|-----------------------------------|
| Series No.                          | WA04P                             |
| Size                                | 0402 $\times$ 2 (1005 $\times$ 2) |
| Termination construction            | Convex type                       |
| Attenuation Range                   | 0dB, 0.5dB ~ 20dB                 |
| Attenuation Tolerance               |                                   |
| 0dB                                 | -                                 |
| 0.5dB                               | $\pm 0.1$ dB                      |
| 1dB~ 5dB                            | $\pm 0.3$ dB                      |
| 6dB~ 10dB                           | $\pm 0.4$ dB                      |
| 11dB~ 13dB                          | $\pm 0.8$ dB                      |
| 14dB                                | $\pm 1.0$ dB                      |
| 15dB~ 16dB                          | $\pm 1.5$ dB                      |
| 17dB~ 19dB                          | $\pm 2.0$ dB                      |
| 20dB                                | $\pm 2.5$ dB                      |
| Characteristic impedance            | 50 $\Omega$                       |
| Rated power at Tamb=70 $^{\circ}$ C | 0.1 W / package                   |
| Limiting Voltage (DC)               | 50V                               |
| Frequency range (DC)                | MAX. 3 GHz                        |
| VSWR (Voltage Standing Wave Ratio)  | MAX. 1.2                          |
| Number of Resistors                 | 3 resistors                       |
| Number of Terminals                 | 4 terminals                       |
| Operation Temperature               | -40 ~ 125 $^{\circ}$ C            |

### Physical Dimensions:

| Unit: mm | WA04P           |
|----------|-----------------|
| L        | 1.00 $\pm$ 0.10 |
| W        | 1.00+0.10/-0    |
| T        | 0.35 $\pm$ 0.10 |
| P        | 0.65 $\pm$ 0.20 |
| A        | 0.33 $\pm$ 0.10 |
| Ta       | 0.15 $\pm$ 0.10 |
| Tb       | 0.25 $\pm$ 0.10 |

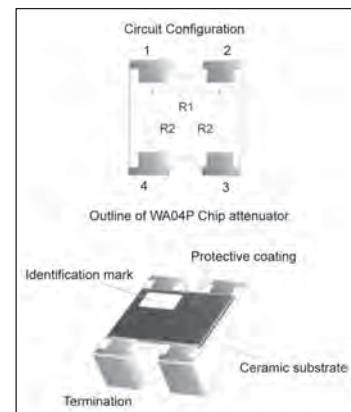
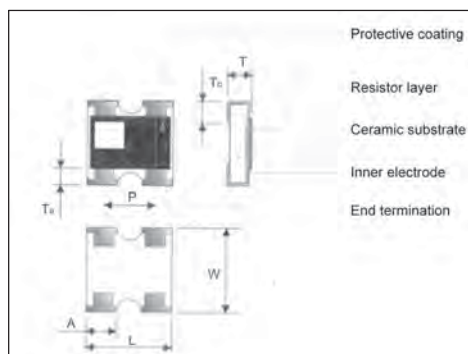

## Special Application Chip Resistors

### Feature

1. Provided Automotive & Anti-sulfuration resistors (MR/SR series) for Auto & Anti-sulfuration application.
2. Provided Total Lead Free resistors (WR\_R series) to fulfill RoHS environmental regulation.
3. Provided trimmable resistors (WKxxM series) for customer special tolerance requirement.
4. Provided high precision tolerance (WFxxH/ WFxxT/ WFxxU/ WFxxW) down to  $\pm 0.05\%$  and TCR down to  $10\text{ppm}/^\circ\text{C}$  for voltage sensing.
5. High reliability and stability.
6. Reduced size of final equipment
7. Lower assembly costs.
8. Higher component and equipment reliability
9. Special resistance, tolerance are available upon customer's request.

## MR/SR Series of Automotive & Anti-sulfuration Chip Resistor

### Feature

1. High reliability and stability  $\pm 1\%$ .
2. Sulfuration resistant
3. Automotive grade AEC Q-200 compliant.
4. 100% CCD inspection.
5. RoHS compliant and lead free.

### Application

1. Automotive application.
2. Consumer electrical equipment.
3. EDP, Computer application.
4. Telecom Application.

### Quick Reference Data

| Series No.                                  | MR12X  | MR08X      | MR06X      | MR04X      |
|---|--|------------|------------|------------|
| Size code                                   | 1206(3126)   | 0805(2012) | 0603(1608) | 0402(1005) |
| Resistance Range                            | 1 $\Omega$ ~10M $\Omega$ ( $\pm 1\%$ , $\pm 5\%$ ), Jumper |            |            |            |
| TCR (ppm/ $^\circ\text{C}$ )                | $\pm 200$ ppm*   |            |            |            |
| Max. dissipation @ Tamb=70 $^\circ\text{C}$ | 1/4 W  | 1/8 W      | 1/10 W     | 1/16 W     |
| Max. Operation Voltage (DC or RMS)          | 200V   | 150V       | 75V        | 50V        |
| Operation Temperature                       | -55 ~ +155   |            |            |            |

| Series No.                                  | SR12X  | SR08X      | SR06X      | SR04X      |
|---|--|------------|------------|------------|
| Size code                                   | 1206(3126)   | 0805(2012) | 0603(1608) | 0402(1005) |
| Resistance Range                            | 1 $\Omega$ ~10M $\Omega$ ( $\pm 1\%$ , $\pm 5\%$ ), Jumper |            |            |            |
| TCR (ppm/ $^\circ\text{C}$ )                | $\pm 200$ ppm*   |            |            |            |
| Max. dissipation @ Tamb=70 $^\circ\text{C}$ | 1/4 W  | 1/8 W      | 1/10 W     | 1/16 W     |
| Max. Operation Voltage (DC or RMS)          | 200V   | 150V       | 75V        | 50V        |
| Operation Temperature                       | -55 ~ +155   |            |            |            |

Remark: \*Detail specification please refer to specific data sheets!

\*MR series can withstand H2S 3ppm $\times$ 1000hrs.

\*SR series can withstand H2S 1000ppm $\times$ 720hrs.

## WR\_R Series of Total Lead Free Chip Resistors

### Feature

1. High reliability and stability
2. Reduced size of final equipment
3. Lower assembly cost
4. Higher component and equipment reliability
5. RoHS compliant and total lead free

### Quick Reference Data

| Series No.                                  | MR12X  | MR08X      | MR06X      | MR04X      |
|---|--|------------|------------|------------|
| Size code                                   | 1206(3126)   | 0805(2012) | 0603(1608) | 0402(1005) |
| Resistance Range                            | 1 $\Omega$ ~10M $\Omega$ ( $\pm 1\%$ , $\pm 5\%$ ), Jumper |            |            |            |
| TCR (ppm/ $^\circ\text{C}$ )                | $\pm 200$ ppm*   |            |            |            |
| Max. dissipation @ Tamb=70 $^\circ\text{C}$ | 1/4 W  | 1/8 W      | 1/10 W     | 1/16 W     |
| Max. Operation Voltage (DC or RMS)          | 200V   | 150V       | 50V        | 50V        |
| Operation Temperature                       | -55 ~ +155   |            |            |            |

Remark: \*Detail specification please refer to specific data sheets!

### Part No. Definition

| 1 <sup>st</sup> code | 2 <sup>nd</sup> code | 3 <sup>rd</sup> - 4 <sup>th</sup> code | 5 <sup>th</sup> code | 6 <sup>th</sup> - 9 <sup>th</sup> code | 10 <sup>th</sup> code | 11 <sup>th</sup> code | 12 <sup>th</sup> code |
|----------------------|----------------------|--|----------------------|--|-----------------------|-----------------------|-----------------------|
| □                    | □                    | □□                                     | □                    | □□□□                                   | □                     | □                     | <u>R</u>              |
| WTC                  | Type code            | Size code                              | Functional code      | Marking code (Resistance)              | Tolerance code        | Packaging code        | Termination code      |
| For example:         |                      |  |                      |  |                       |                       |                       |
| W                    | R                    | 04                                     | X                    | 1000                                   | F                     | T                     | R                     |



## WKxxM Series of Trimmable Chip Resistors

### Feature

1. High precision, reliability and stability
2. Miniature size down to 00603 (1608)

### Description

The resistors are constructed on a high grade ceramic body (aluminum oxide). Internal metal electrodes are added at each end and connected by a resistive paste that is applied to the top surface of the substrate. The composition of the paste is adjusted to give the approximate resistance required.

The resistive layer is covered with a transparent protective coat. Finally, the two external end terminations are added. For ease of soldering the outer layer of these end termination is Tin (Pb free) solder alloy.

### Physical Dimensions

Unit: mm

| Type | WK25M     | WK20M     | WK10M     | WK12M     | WK08M     | WK06M           |
|------|-----------|-----------|-----------|-----------|-----------|-----------------|
| L    | 6.30±0.15 | 5.00±0.15 | 3.10±0.15 | 3.10±0.15 | 2.00±0.10 | 1.60±0.10       |
| W    | 3.20±0.15 | 2.50±0.15 | 2.50±0.15 | 1.60±0.15 | 1.25±0.10 | 0.80±0.15/-0.10 |
| T    | 0.55±0.15 | 0.55±0.15 | 0.55±0.15 | 0.55±0.10 | 0.55±0.10 | 0.45±0.10       |
| Tb   | 0.60±0.20 | 0.60±0.20 | 0.50±0.25 | 0.50±0.25 | 0.40±0.20 | 0.30±0.10       |
| Tt   | 0.60±0.20 | 0.60±0.20 | 0.50±0.25 | 0.50±0.25 | 0.40±0.20 | 0.30±0.10       |

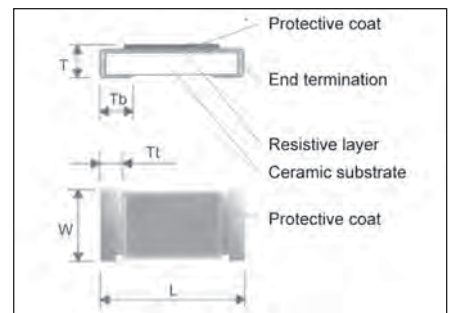
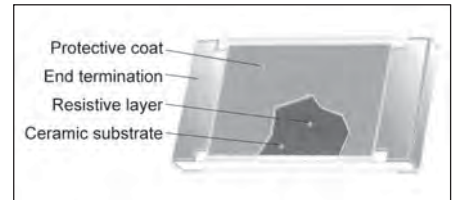

### Quick Reference Data

| Series No.                         | WK25M   | WK20M       | WK10M      | WK12M      | WK08M      | WK06M       |
|------------------------------------|---|-------------|------------|------------|------------|-------------|
| Size code                          | 2512 (6332)   | 2010 (5025) | 1210(3225) | 1206(3216) | 0805(2012) | 0603(1608)  |
| Resistance Tolerance               | 0/-20%(Y) and 0/-30%(X) E24 series                        |             |            |            |            |             |
| Resistance Range                   | 1Ω ~ 4.7MΩ  |             |            |            |            | 10Ω ~ 4.7MΩ |
| TCR (ppm/°C)                       | 10Ω ~ 4.7MΩ: ±200 ppm/°C<br>1Ω ~ 9.1Ω: -200 ~ +500 ppm/°C |             |            |            |            | ±200 ppm/°C |
| Max. dissipation @ Tamb=70°C       | 1 W   | 1/2 W       | 1/4 W      | 1/8 W      | 1/10 W     | 1/16 W      |
| Max. Operation Voltage (DC or RMS) | 200V  | 200V        | 200V       | 200V       | 150V       | 50V         |
| Operation Temperature              | -55 ~ +125  |             |            |            |            |             |
| Basic Specification                | JIS C 5201-1 / IEC 60115-1                                |             |            |            |            |             |

## WKxxV Series of High Voltage Chip Resistors

### Feature

1. Special material and design for high working voltage required
2. Compatible with flow and reflow soldering.
3. Suitable for lead free soldering.

### Application

1. Power supply.
2. Automotive industry.
3. Measurement instrument.
4. Back light inverter.
5. Medical or Military equipment

### Quick Reference Data

| Series No.                         | WK25V                                     | WK20V       | WK12V      | WK08V      | WK06V      |
|------------------------------------|---|-------------|------------|------------|------------|
| Size code                          | 2512 (6332)                               | 2010 (5025) | 1206(3216) | 0805(2012) | 0603(1608) |
| Resistance Tolerance               | ±5% ; ±1%                                 |             |            |            |            |
| Resistance Range                   | 47Ω ~ 51MΩ                                |             |            |            | 47Ω ~ 10MΩ |
| TCR (ppm/°C)                       | ± 200 ppm/°C * detail refer to data sheet |             |            |            |            |
| Max. dissipation @ Tamb=70°C       | 1 W                                       | 1/2 W       | 1/4 W      | 1/8 W      | 1/10 W     |
| Max. Operation Voltage (DC or RMS) | 800V                                      | 500V        | 500V       | 400V       | 200V       |
| Operation Temperature              | -55 ~ +125                                |             |            |            |            |

Note :

1. This is the maximum voltage that may be continuously supplied to the resistor element, see "IEC publication 60115-8".
2. Max. Operation Voltage : So called RCWW (Rated Continuous Working Voltage) is determined by  $RCWW = \sqrt{\text{Rater Power} \times \text{Resistance Value}}$  or Max. RCWW listed above, whichever is lower.

### Physical Dimensions

Unit: mm

| Symbol | WK25V     | WK20V     | WK12V     | WK08V     | WK06V           |
|--------|-----------|-----------|-----------|-----------|-----------------|
| L      | 6.30±0.15 | 5.00±0.15 | 3.10±0.15 | 2.00±0.10 | 1.60±0.10       |
| W      | 3.20±0.15 | 2.50±0.15 | 1.60±0.15 | 1.25±0.10 | 0.80±0.15/-0.10 |
| T      | 0.55±0.15 | 0.55±0.15 | 0.55±0.10 | 0.55±0.10 | 0.45±0.10       |
| Tt     | 0.60±0.20 | 0.60±0.20 | 0.50±0.25 | 0.40±0.20 | 0.30±0.10       |
| Tb     | 0.60±0.20 | 0.60±0.20 | 0.50±0.25 | 0.40±0.20 | 0.30±0.10       |

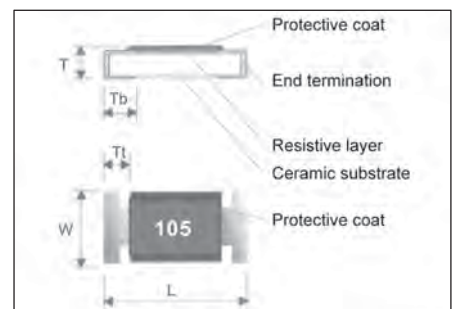

## WFxxP Series of High Power Chip Resistors

### Feature

1. High power rating and compact size
2. High reliability and stability
3. Reduced size of final equipment
4. Lead free product is upon customer requested

### Application

1. Power supply
2. PDA
3. Digital meter
4. Computer
5. Automotives.

### Quick Reference Data

| Item                               | General Specification |            |            |            |            |             |            |
|------------------------------------|-----------------------|------------|------------|------------|------------|-------------|------------|
| Series No.                         | WF25P                 | WF20P      | WF10P      | WF12P      | WF08P      | WF06P       | WF04P      |
| Size code                          | 2512(6432)            | 2010(5025) | 1210(3225) | 1206(3216) | 0805(2012) | 0603 (1608) | 0402(1005) |
| Resistance Tolerance               | ±1% , ±5%             |            |            |            |            |             |            |
| Resistance Range                   | 0Ω, 1Ω ~ 1MΩ          |            |            |            |            |             |            |
| TCR (ppm/°C)                       | ± 100 ppm/°C          |            |            |            |            |             |            |
| Max. dissipation @ Tamb=70°C       | 2W                    | 1W         | 1/2W       | 1/2W       | 1/4W       | 1/8W        | 1/8W       |
| Max. Operation Voltage (DC or RMS) | 300V                  | 200V       | 200V       | 200V       | 150V       | 50V         | 50V        |
| Operation Temperature              | -55 ~ +155            |            |            |            |            |             |            |

Note :

1. This is the maximum voltage that may be continuously supplied to the resistor element, see "IEC publication 60115-8".
2. Max. Operation Voltage : So called RCWW (Rated Continuous Working Voltage) is determined by  $RCWW = \sqrt{\text{Rater Power} \times \text{Resistance Value}}$  or Max. RCWW listed above, whichever is lower.
3. 2W loading with total solder-pad and trace size of 300mm<sup>2</sup>
4. 0Ω maximum resistance Rmax < 15mΩ and rated current < 4Amp

### Physical Dimensions

Unit: mm

| Symbol | WF25P     | WF20P     | WF10P     | WF12P     | WF08P     | WF06P     | WF04P     |
|--------|-----------|-----------|-----------|-----------|-----------|-----------|-----------|
| L      | 6.30±0.20 | 5.00±0.20 | 3.10±0.10 | 3.10±0.15 | 2.00±0.15 | 1.60±0.10 | 1.00±0.05 |
| W      | 3.10±0.20 | 2.50±0.20 | 2.60±0.10 | 1.60±0.15 | 1.20±0.15 | 0.80±0.10 | 0.50±0.05 |
| T      | 0.60±0.15 | 0.60±0.10 | 0.55±0.10 | 0.55±0.10 | 0.50±0.10 | 0.45±0.10 | 0.35±0.05 |
| Tt     | 0.60±0.25 | 0.60±0.25 | 0.50±0.20 | 0.50±0.25 | 0.40±0.20 | 0.30±0.20 | 0.25±0.10 |
| Tb     | 1.80±0.25 | 0.60±0.25 | 0.50±0.20 | 0.50±0.25 | 0.40±0.20 | 0.30±0.20 | 0.25±0.10 |

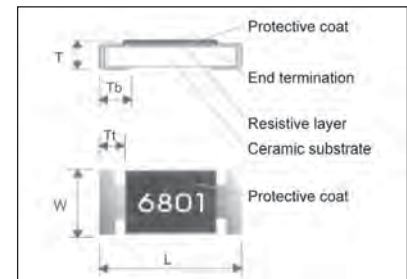

## WKxxS Series of Anti-Surge Chip Resistors

### Feature

1. Power rating and compact size
2. High reliability and stability
3. Reduced size of final equipment
4. Surge protection

### Application

1. Power supply.
2. Measurement instrument.
3. Automotive industry.
4. Medical or Military equipment.

### Quick Reference Data

| Item                               | General Specification     |            |            |            |            |
|------------------------------------|---------------------------|------------|------------|------------|------------|
| Series No.                         | WK25S                     | WK20S      | WK10S      | WK12S      | WK08S      |
| Size code                          | 2512(6432)                | 2010(5025) | 1210(3225) | 1206(3216) | 0805(2012) |
| Resistance Tolerance               | ±5% , ±10% , ±20% , (E24) |            |            |            |            |
| Resistance Range                   | 0.27Ω ~ 22MΩ              |            |            |            |            |
| TCR (ppm/°C)                       | ± 200 ppm/°C              |            |            |            |            |
| Max. dissipation @ Tamb=70°C       | 1 W                       | 3/4W       | 1/2W       | 1/4W       | 1/8W       |
| Max. Operation Voltage (DC or RMS) | 200V                      |            |            |            | 150V       |
| Operation Temperature              | -55 ~ +155                |            |            |            |            |

Note :

1. This is the maximum voltage that may be continuously supplied to the resistor element, see "IEC publication 60115-8".
2. Max. Operation Voltage : So called RCWW (Rated Continuous Working Voltage) is determined by  $RCWW = \sqrt{\text{Rater Power} \times \text{Resistance Value}}$  or Max. RCWW listed above, whichever is lower.

### Physical Dimensions

Unit: mm

| Symbol | WK25S     | WK20S     | WK10S     | WK12S     | WK08S     |
|--------|-----------|-----------|-----------|-----------|-----------|
| L      | 6.30±0.15 | 5.00±0.15 | 3.20±0.15 | 3.20±0.15 | 2.00±0.10 |
| W      | 3.20±0.15 | 2.50±0.15 | 2.50±0.15 | 1.60±0.15 | 1.25±0.10 |
| T      | 0.55±0.15 | 0.55±0.15 | 0.55±0.15 | 0.55±0.10 | 0.55±0.10 |
| Tt     | 0.30±0.15 | 0.30±0.15 | 0.30±0.20 | 0.30±0.20 | 0.30±0.20 |
| Tb     | 0.60±0.20 | 0.60±0.20 | 0.50±0.25 | 0.50±0.25 | 0.40±0.20 |

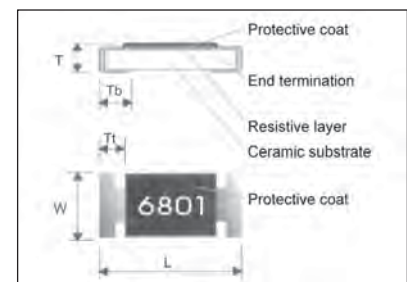
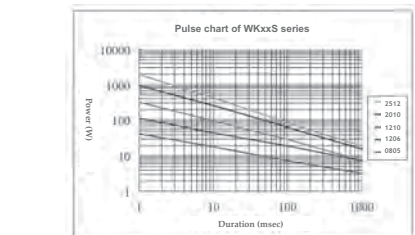

## High Precision Chip Resistors

### Narrow Tolerance Thick Film TC100 WFxxH Series

| Series No.                         | WF12H                      | WF08H      | WF06H      | WF04H      |
|------------------------------------|----------------------------|------------|------------|------------|
| Size                               | 1206(3216)                 | 0805(2012) | 0603(1608) | 0402(1005) |
| Resistance Tolerance               | ±0.5% , ±0.1%              |            |            |            |
| Resistance Range                   | 10Ω ~ 1MΩ (E96+E24 series) |            |            |            |
| TCR (ppm/°C)                       | ±100 ppm/°C                |            |            |            |
| Max. dissipation @ Tamb=70°C       | 1/4 W                      | 1/8 W      | 1/10 W     | 1/16 W     |
| Max. Operation Voltage (DC or RMS) | 200V                       | 100V       | 50V        | 50V        |
| Operation Temperature              | -55 ~ +155                 |            |            |            |
| Basic Specification                | JIS C5201-1 / IEC 60115-1  |            |            |            |

(Detail specification please refer to specific data sheets)

### Narrow Tolerance Thin Film TC50 WFxxT/ WFxxQ Series

| Series No.                         | WF25T                      | WF25Q          | WF20T          | WF20Q          | WF10T          | WF10Q          | WF12T          | WF12Q          | WF08T          | WF08Q          | WF06T          | WF06Q          | WF04T          |
|------------------------------------|----------------------------|----------------|----------------|----------------|----------------|----------------|----------------|----------------|----------------|----------------|----------------|----------------|----------------|
| Size                               | 2512<br>(6432)             | 2512<br>(6432) | 2010<br>(5025) | 2010<br>(5025) | 1210<br>(3225) | 1210<br>(3225) | 1206<br>(3216) | 1206<br>(3216) | 0805<br>(2012) | 0805<br>(2012) | 0603<br>(1608) | 0603<br>(1608) | 0402<br>(1005) |
| Resistance Tolerance               | ±1%, ±0.5% , ±0.1%, ±0.05% |                |                |                |                |                |                |                |                |                |                |                |                |
| Resistance Range                   | 10 ~ 1.5MΩ                 |                |                |                | 10 ~ 1MΩ       |                | 4.7 ~ 1MΩ      |                |                | 4.7 ~ 680KΩ    |                | 10 ~ 100KΩ     |                |
| TCR (ppm/°C)                       | ±50 ppm/°C                 |                |                |                |                |                |                |                |                |                |                |                |                |
| Max. dissipation @ Tamb=70°C       | 3/4W                       | 1W             | 1/2W           | 3/4W           | 1/4W           | 2/5W           | 1/8W           | 1/4W           | 1/10W          | 1/8W           | 1/16W          | 1/10W          | 1/16W          |
| Max. Operation Voltage (DC or RMS) | 200V                       | 200V           | 200V           | 200V           | 200V           | 200V           | 200V           | 200V           | 100V           | 150V           | 50V            | 75V            | 25V            |
| Operation Temperature              | -55 ~ +155                 |                |                |                |                |                |                |                |                |                |                |                |                |
| Basic Specification                | JIS C5201-1 / IEC 60115-1  |                |                |                |                |                |                |                |                |                |                |                |                |

(Detail specification please refer to specific data sheets)

### Narrow Tolerance Thin Film TC25 WFxxU/ WFxxR Series

| Series No.                         | WF25U                      | WF25R          | WF20U          | WF20R          | WF10U          | WF10R          | WF12U          | WF12R          | WF08U          | WF08R          | WF06U          | WF06R          | WF04U          |
|------------------------------------|----------------------------|----------------|----------------|----------------|----------------|----------------|----------------|----------------|----------------|----------------|----------------|----------------|----------------|
| Size                               | 2512<br>(6432)             | 2512<br>(6432) | 2010<br>(5025) | 2010<br>(5025) | 1210<br>(3225) | 1210<br>(3225) | 1206<br>(3216) | 1206<br>(3216) | 0805<br>(2012) | 0805<br>(2012) | 0603<br>(1608) | 0603<br>(1608) | 0402<br>(1005) |
| Resistance Tolerance               | ±1%, ±0.5% , ±0.1%, ±0.05% |                |                |                |                |                |                |                |                |                |                |                |                |
| Resistance Range                   | 10 ~ 1.5MΩ                 |                |                |                | 10 ~ 1MΩ       |                | 4.7 ~ 1MΩ      |                |                | 4.7 ~ 680KΩ    |                | 10 ~ 100KΩ     |                |
| TCR (ppm/°C)                       | ±25 ppm/°C                 |                |                |                |                |                |                |                |                |                |                |                |                |
| Max. dissipation @ Tamb=70°C       | 3/4W                       | 1W             | 1/2W           | 3/4W           | 1/4W           | 2/5W           | 1/8W           | 1/4W           | 1/10W          | 1/8W           | 1/16W          | 1/10W          | 1/16W          |
| Max. Operation Voltage (DC or RMS) | 200V                       | 200V           | 200V           | 200V           | 200V           | 200V           | 200V           | 200V           | 100V           | 150V           | 50V            | 75V            | 25V            |
| Operation Temperature              | -55 ~ +155                 |                |                |                |                |                |                |                |                |                |                |                |                |
| Basic Specification                | JIS C5201-1 / IEC 60115-1  |                |                |                |                |                |                |                |                |                |                |                |                |

(Detail specification please refer to specific data sheets)

### Narrow Tolerance Thin Film TC15 WFxxF Series

| Series No.                         | WF12F                     | WF08F       | WF06F       | WF04F       |
|------------------------------------|---------------------------|-------------|-------------|-------------|
| Size                               | 1206 (3216)               | 0805 (2012) | 0603 (1608) | 0402 (1005) |
| Resistance Tolerance               | ±0.5%, ±0.1%, ±0.05%      |             |             |             |
| Resistance Range                   | 25 ~ 300KΩ                | 25 ~ 200KΩ  | 25 ~ 100KΩ  | 25 ~ 20KΩ   |
| TCR (ppm/°C)                       | ± 15 ppm/°C               |             |             |             |
| Max. dissipation @ Tamb=70°C       | 1/8W                      | 1/8W        | 1/10W       | 1/16W       |
| Max. Operation Voltage (DC or RMS) | 150V                      | 100V        | 50V         | 25V         |
| Operation Temperature              | -55 ~ +155                |             |             |             |
| Basic Specification                | JIS C5201-1 / IEC 60115-1 |             |             |             |

(Detail specification please refer to specific data sheets) \* Sample is available upon request

### Narrow Tolerance Thin Film TC10 WFxxW Series

| Series No.                         | WF12W                     | WF08W      | WF06W      | WF04W      |
|------------------------------------|---------------------------|------------|------------|------------|
| Size                               | 1206(3216)                | 0805(2012) | 0603(1608) | 0402(1005) |
| Resistance Tolerance               | ±0.5% , ±0.1%, ±0.05%     |            |            |            |
| Resistance Range                   | 25 ~ 300KΩ                | 25 ~ 200KΩ | 25 ~ 100KΩ | 25 ~ 20KΩ  |
| TCR (ppm/°C)                       | ± 10 ppm/°C               |            |            |            |
| Max. dissipation @ Tamb=70°C       | 1/8W                      | 1/8W       | 1/10W      | 1/16W      |
| Max. Operation Voltage (DC or RMS) | 150V                      | 100V       | 50V        | 25V        |
| Operation Temperature              | -55 ~ +155                |            |            |            |
| Basic Specification                | JIS C5201-1 / IEC 60115-1 |            |            |            |

(Detail specification please refer to specific data sheets)

### Narrow Tolerance Thin Film TC5 WFxxZ Series

| Series No.                         | WF12Z                     | WF08Z      | WF06Z      | WF04Z      |
|------------------------------------|---------------------------|------------|------------|------------|
| Size                               | 1206(3216)                | 0805(2012) | 0603(1608) | 0402(1005) |
| Resistance Tolerance               | ±0.5% , ±0.1%, ±0.05%     |            |            |            |
| Resistance Range                   | 25 ~ 120KΩ                | 25 ~ 80KΩ  | 25 ~ 40KΩ  | 25 ~ 8KΩ   |
| TCR (ppm/°C)                       | ±5 ppm/°C                 |            |            |            |
| Max. dissipation @ Tamb=70°C       | 1/8W                      | 1/8W       | 1/10W      | 1/16W      |
| Max. Operation Voltage (DC or RMS) | 150V                      | 100V       | 50V        | 25V        |
| Operation Temperature              | -55 ~ +155                |            |            |            |
| Basic Specification                | JIS C5201-1 / IEC 60115-1 |            |            |            |

(Detail specification please refer to specific data sheets)

## Test and Requirements

### For WR Series

| Test  | Procedure / Test Method   | Requirements  |        |
|---|---|---|--------|
|   |   | Resistor  | 0Ω     |
| Electrical Characteristics<br>JISC5201-1: 1998 Clause 4.8             | - DC resistance values measurement<br>- Temperature Coefficient of Resistance (T.C.R)<br>Natural resistance change per change in degree centigrade.<br>$[(R2-R1)/R1(T2-T1)] \times 10^6$ (ppm /°C) T1:20°C+5°C-1°C<br>R1:Resistance at reference temperature (20°C+5°C/-1°C)<br>R2:Resistance at test temperature (-55°C or +155°C) | Within the specified tolerance Refer to "QUICK REFERENCE DATA"                                      | < 50mΩ |
| Resistance to soldering heat(R.S.H)<br>JISC5201-1:1998<br>Clause 4.18 | Un-mounted chips completely immersed for 10±1second in a SAC solder bath at 260°C±5°C   | ±5%: $\Delta R/R_{max}$ . (1%+0.05Ω)<br>±1%: $\Delta R/R_{max}$ . (0.5%+0.05Ω)<br>no visible damage | < 50mΩ |
| Solder ability<br>JISC5201-1:1998<br>Clause 4.17                      | Un-mounted chips completely immersed for 2±0.5 second in a SAC solder bath at 235°C±5°C   | 95% coverage min., good tinning and no visible damage   |        |
| Temperature cycling<br>JISC5201-1:1998<br>Clause 4.19                 | 30minutes at -55°C±3°C, 2~3minutes at 20°C+5°C-1°C,30minutes at +155°C±3°C,2~3minutes at 20°C+5°C-1°C,total 5continuous cycles  | ±5%: $\Delta R/R_{max}$ . (1%+0.05Ω)<br>±1%: $\Delta R/R_{max}$ . (0.5%+0.05Ω)<br>no visible damage | < 50mΩ |
| High Temperature Exposure<br>MIL-STD-202<br>Mothod 108                | 1000+48/-0 hours; without load in a temperature chamber controlled 155°C±3°C  | ±5%: $\Delta R/R_{max}$ . (2%+0.1Ω)<br>±1%: $\Delta R/R_{max}$ . (1%+0.1Ω)<br>no visible damage     | < 50mΩ |
| Bending strength<br>JISC5201-1:1998<br>Clause 4.33                    | Resistors mounted on a 90mm glass epoxy resin PCB(FR-4), bending once 3mm for 10sec, 5mm for WR04   | ±5%: $\Delta R/R_{max}$ . (1%+0.05Ω)<br>±1%: $\Delta R/R_{max}$ . (1%+0.05Ω)<br>no visible damage   | < 50mΩ |
| Adhesion<br>JISC5201-1:1998<br>Clause 4.32                            | Pressurizing force: 5N, Test time: 10±1sec.   | No remarkable damage or removal of the terminations   |        |
| Short Time Overload (STOL)<br>JISC5201-1:1998<br>Clause 4.13          | 2.5 times RCWV or max. overload voltage, for 5seconds   | ±5%: $\Delta R/R_{max}$ . (2%+0.1Ω)<br>±1%: $\Delta R/R_{max}$ . (1%+0.1Ω)<br>no visible damage     | < 50mΩ |
| Load life in Humidity<br>JISC5201-1:1998<br>Clause 4.24               | 1000+48/-0 hours, loaded with RCWV or Vmax in humidity chamber controller 40°C±2°C at and 90~95% relative humidity, 1.5 hours on and 0.5 hours off  | ±5%: $\Delta R/R_{max}$ . (2%+0.1Ω)<br>±1%: $\Delta R/R_{max}$ . (1%+0.1Ω)<br>no visible damage     | < 50mΩ |
| Load life (endurance)<br>JISC5201-1:1998<br>Clause 4.25               | 1000+48/-0 hours, loaded with RCWV or Vmax in chamber controller 70°C±2°C 1.5 hours on and 0.5 hours off  | ±5%: $\Delta R/R_{max}$ . (2%+0.1Ω)<br>±1%: $\Delta R/R_{max}$ . (1%+0.1Ω)<br>no visible damage     | < 50mΩ |
| Insulation Resistance<br>JISC5201-1:1998<br>Clause 4.6                | Apply the maximum overload voltage (DC) for 1minute   | $R \geq 10G\Omega$  |        |
| Dielectric Withstand Voltage<br>JISC5201-1:1998<br>Clause 4.7         | Apply the maximum overload voltage (AC) for 1minute   | No breakdown or flashover   |        |



## ■ For WW Series

| Test  | Procedure / Test Method  | Requirements  |
|---|--|---|
|   |  | Resistor  |
| Electrical Characteristics<br>JISC5201-1: 1998 Clause 4.8             | - DC resistance values measurement<br>- Temperature Coefficient of Resistance (T.C.R)<br>Natural resistance change per change in degree centigrade.<br>$[(R2-R1)/R1(T2-T1)] \times 10^6$ (ppm/°C) T1:20°C+5°C-1°C<br>R1:Resistance at reference temperature (20°C+5°C/-1°C)<br>R2:Resistance at test temperature (-55°C or +155°C) | Within the specified tolerance<br>Refer to "QUICK REFERENCE DATA" |
| Resistance to soldering heat(R.S.H)<br>JISC5201-1:1998<br>Clause 4.18 | Un-mounted chips completely immersed for 10±1second in a SAC solder bath at 260°C±5°C  | ΔR/R max. ±(1%+0.005Ω)<br>no visible damage                       |
| Solder ability<br>JISC5201-1:1998<br>Clause 4.17                      | Un-mounted chips completely immersed for 2±0.5 second in a SAC solder bath at 235°C±5°C  | 95% coverage min., good tinning and no visible damage             |
| Temperature cycling<br>JISC5201-1:1998<br>Clause 4.19                 | 30minutes at -55°C±3°C, 2~3minutes at 20°C+5°C-1°C,30minutes at +155°C±3°C,2~3minutes at 20°C+5°C-1°C, total 5continuous cycles  | ΔR/R max. ±(1%+0.005Ω)<br>no visible damage                       |
| High Temperature Exposure<br>MIL-STD-202<br>Method 108                | 1000+48/-0 hours; without load in a temperature chamber controlled 155°C±3°C   | ΔR/R max. ±(3%+0.005Ω)<br>no visible damage                       |
| Bending strength<br>JISC5201-1:1998<br>Clause 4.33                    | Resistors mounted on a 90mm glass epoxy resin PCB(FR-4), bending once 3mm for 10sec, 5mm for WR04  | ΔR/R max. ±(1%+0.005Ω)<br>no visible damage                       |
| Adhesion<br>JISC5201-1:1998<br>Clause 4.32                            | Pressurizing force: 5N, Test time: 10±1sec.  | No remarkable damage or removal of the terminations               |
| Short Time Overload (STOL)<br>JISC5201-1:1998<br>Clause 4.13          | 2.5 times RCWV or max. overload voltage, for 5 seconds   | ΔR/R max. ±(2%+0.005Ω)<br>no visible damage                       |
| Load life in Humidity<br>JISC5201-1:1998<br>Clause 4.24               | 1000+48/-0 hours, loaded with RCWV or Vmax in humidity chamber controller 40°C±2°C at and 90~95% relative humidity, 1.5 hours on and 0.5 hours off   | ΔR/R max. ±(3%+0.005Ω)<br>no visible damage                       |
| Load life (endurance)<br>JISC5201-1:1998<br>Clause 4.25               | 1000+48/-0 hours, loaded with RCWV or Vmax in chamber controller 70°C±2°C 1.5 hours on and 0.5 hours off   | ΔR/R max. ±(3%+0.005Ω)<br>no visible damage                       |
| Insulation Resistance<br>JISC5201-1:1998<br>Clause 4.6                | Apply the maximum overload voltage (DC) for 1minute  | R ≥ 10GΩ  |
| Dielectric Withstand Voltage<br>JISC5201-1:1998<br>Clause 4.7         | Apply the maximum overload voltage (AC) for 1minute  | No breakdown or flashover   |

## Packing on Tape and Reel

### Paper Tape Specifications for WR,WF,WW Series and WA,WT Series

Unit: mm

| Component Size / Series  | W         | F         | E         | PO        | ΦD        |
|--|-----------|-----------|-----------|-----------|-----------|
| 1206, 0805, 0603, 0402, WA06X, WA06T, WA04X, WA04Y, WA04P, WA04T, WA04U, WT04X | 8.00±0.30 | 3.50±0.20 | 1.75±0.10 | 4.00±0.10 | Φ1.50±0.1 |
| WA06W  | 12.0±0.10 | 5.50±0.05 |           |           |           |
| WR02X  | 8.00±0.20 | 3.50±0.05 |           |           |           |

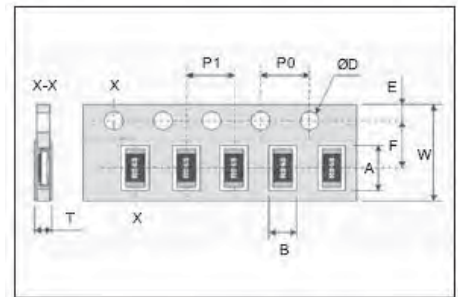

| Component Size / Series  | A           | B           | P1        | T         |
|--------------------------|-------------|-------------|-----------|-----------|
| 1206(3216), WA06X, WA06T | 3.60±0.20   | 2.00±0.20   | 4.00±0.10 | Max. 1.0  |
| 0805(2012)               | 2.40±0.20   | 1.65±0.20   |           | 0.65±0.05 |
| 0603(1608)               | 1.90±0.20   | 1.10±0.20   |           | 0.40±0.05 |
| 0402(1005)               | 1.20±0.10   | 0.70±0.10   | 2.00±0.10 | Max. 0.6  |
| WA04X, WA04T             | 2.20±0.20   | 1.20±0.20   | 2.00±0.05 | 0.45±0.05 |
| WA04Y, WA04P, WA04U      | 1.15±0.10   | 1.15±0.10   | 2.00±0.05 | 0.85±0.05 |
| WT04X                    | 3.45±0.2/-0 | 1.85±0.2/-0 | 4.00±0.10 | 0.65±0.05 |
| WA06W                    | 4.20±0.2/-0 | 1.80±0.2/-0 | 4.00±0.10 | 0.45±0.05 |
| WR02X                    | 0.67±0.05   | 0.37±0.05   | 2.00±0.05 |           |

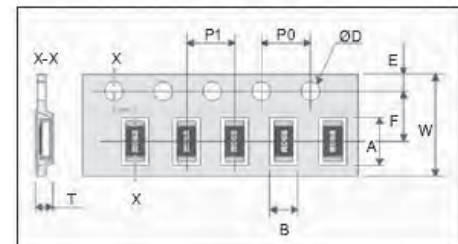

### Plastic Tape Specifications for WR, WF, WW Series of Chip-R

Unit: mm

| Component Size | 2512(6432) | 2010(5025) | 1218(3248) |
|----------------|------------|------------|------------|
| A              | 6.90±0.20  | 5.50±0.20  | 3.55±0.30  |
| B              | 3.60±0.20  | 2.80±0.20  | 4.90±0.20  |
| W              | 12.00±0.30 |            |            |
| F              | 5.50±0.10  |            |            |
| E              | 1.75±0.10  |            |            |
| P1             | 4.00±0.10  | 8.00±0.10  |            |
| P0             | 4.00±0.10  |            |            |
| ΦD             | Φ1.50±0.1  |            |            |
| T              | Max. 1.2   |            |            |

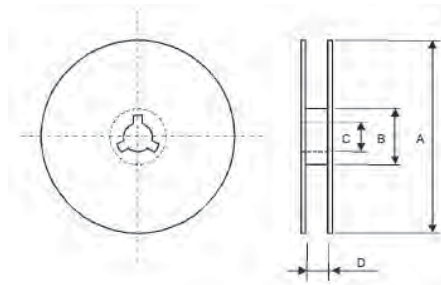

### Plastic Tape Specifications for WR, WF, WW Series of Chip-R

Unit: mm

| Reel/Tape              | A           | B           | C         | D         |
|------------------------|-------------|-------------|-----------|-----------|
| 7" reel for 8mm tape   | Φ178.0±0.20 | Φ60.0±1.00  | 13.0±0.20 | 9.00±0.50 |
| 7" reel for 12mm tape  |             |             |           | 12.4±1.00 |
| 10" reel for 8mm tape  | Φ254.0±2.00 | Φ100.0±1.00 | 13.0±0.20 | 9.00±0.50 |
| 10" reel for 12mm tape | Φ254.0±2.00 | Φ100.0±1.00 | 13.0±0.20 | 14.0±0.20 |
| 13" reel for 8mm tape  | Φ330.0±2.00 | Φ100.0±1.00 | 13.0±0.20 | 9.00±0.50 |

### Paper Tape Specifications for WR,WF,WW Series and WA,WT Series

Unit: mm

| Component Size / Series                     | Q'ty per reel | Reel Diameter |
|---|---------------|---------------|
| 0603, 0805, 1206                            | 1,000 pcs     | 4" reel       |
| 1210, 1206, 0805, 0603, WA06X, WA06T, WT04X | 5,000 pcs     | 7" reel       |
| 0402, WA04X, WA04Y, WA04P, WA04T, WA04U     | 10,000 pcs    | 7" reel       |
| 0201, 0402                                  | 15,000 pcs    | 7" reel       |
| WA06X, WA06Y                                | 5,000 pcs     | 7" reel       |
| 2512, 2010                                  | 4,000 pcs     | 7" reel       |
| 1218  | 3,000 pcs     | 10" reel      |
| 1206, 0805, 0603, WA06X, WA06T              | 10,000 pcs    | 10" reel      |
| 0402, WA04X, WA04Y                          | 20,000 pcs    | 10" reel      |
| 2010, 2512                                  | 8,000 pcs     | 10" reel      |
| 0402  | 70,000 pcs    | 13" reel      |
| WA04X, WA04Y                                | 40,000 pcs    | 13" reel      |
| 1206, 0805, 0603, WA06X,                    | 20,000 pcs    | 13" reel      |
| 2010, 2512                                  | 16,000 pcs    | 13" reel      |

## Footprint Design

### Footprint Design for WRxx, WFxx, WWxx Series :

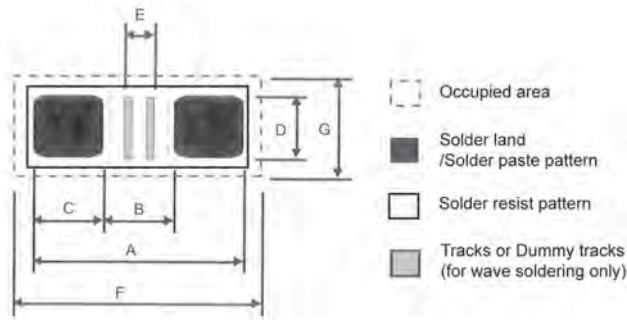

Unit: mm

| Size  | Reflow Soldering |      |      |      |      |      |      | Processing Remarks        | Placement Accuracy |
|-------|------------------|------|------|------|------|------|------|---------------------------|--------------------|
|       | A                | B    | C    | D    | E    | F    | G    |                           |                    |
| 01005 | 0.58             | 0.18 | 0.20 | 0.20 | 0.10 | 0.90 | 0.40 | IR or hot plate soldering | ±0.03              |
| 0201  | 0.75             | 0.30 | 0.30 | 0.30 | 0.20 | 1.10 | 0.50 |                           | ±0.05              |
| 0402  | 1.50             | 0.50 | 0.50 | 0.60 | 0.10 | 1.90 | 1.00 |                           | ±0.15              |
| 0603  | 2.10             | 0.90 | 0.60 | 0.90 | 0.50 | 2.35 | 1.45 |                           | ±0.25              |
| 0805  | 2.60             | 1.20 | 0.70 | 1.30 | 0.75 | 2.85 | 1.90 |                           | ±0.25              |
| 1206  | 3.80             | 2.00 | 0.90 | 1.60 | 1.60 | 4.05 | 2.25 |                           | ±0.25              |
| 1210  | 3.80             | 2.00 | 0.90 | 2.80 | 1.60 | 4.05 | 3.15 |                           | ±0.25              |
| 1218  | 3.80             | 2.00 | 0.90 | 4.80 | 1.40 | 4.20 | 5.50 |                           | ±0.25              |
| 2010  | 5.60             | 3.80 | 0.90 | 2.80 | 3.40 | 5.85 | 3.15 |                           | ±0.25              |
| 2512  | 7.00             | 3.80 | 1.60 | 3.50 | 3.40 | 7.25 | 3.85 |                           | ±0.25              |

| Size | Wave Soldering |      |      |      |      |      |      | Processing Number & Dimensions of dummy tracks | Placement Accuracy |
|------|----------------|------|------|------|------|------|------|--|--------------------|
|      | A              | B    | C    | D    | E    | F    | G    |  |                    |
| 0603 | 2.70           | 0.90 | 0.90 | 0.80 | 0.15 | 3.40 | 1.90 | 1× (0.15 × 0.80)                               | ±0.25              |
| 0805 | 3.40           | 1.30 | 1.05 | 1.30 | 0.20 | 4.30 | 2.70 | 1× (0.20 × 1.30)                               | ±0.25              |
| 1206 | 4.80           | 2.30 | 1.25 | 1.70 | 1.25 | 5.90 | 3.20 | 3× (0.25 × 1.70)                               | ±0.25              |
| 1210 | 4.80           | 2.30 | 1.25 | 2.50 | 1.25 | 5.90 | 3.60 | 3× (0.25 × 1.70)                               | ±0.25              |
| 1218 | 4.80           | 2.30 | 1.25 | 4.80 | 1.30 | 5.90 | 5.60 | 3× (0.25 × 4.80)                               | ±0.25              |
| 2010 | 6.30           | 3.50 | 1.40 | 2.50 | 3.00 | 7.00 | 3.60 | 3× (0.75 × 2.50)                               | ±0.25              |
| 2512 | 8.50           | 4.50 | 2.00 | 3.20 | 3.00 | 9.00 | 4.30 | 3× (1.00 × 3.20)                               | ±0.25              |

### Footprint Design for Array Resistor/Attenuator :

Unit: mm

| Symbol | 0603*4 array    | 0402*4 array    | WA04Y, WA04P    | WA06W           | WA02Y         |
|--------|-----------------|-----------------|-----------------|-----------------|---------------|
| A      | 2.85±0.10/-0.05 | 1.80±0.15/-0.05 | 1.20±0.05       | 3.85±0.20/-0.05 | 1.00±0.05     |
| B      | 0.45±0.05       | 0.30±0.05       | 0.40 +0/-0.05   | 0.28 +0/-0.05   | 0.40 +0/-0.05 |
| D      | 0.80±0.10       | 0.50±0.10       | 0.50±0.05       | 1.00 +0.1/-0.20 | 0.30±0.05     |
| P      | 0.8             | 0.5             | 0.65            | 0.5             | 0.5           |
| F      | 3.10±0.30       | 2.00±0.40/-0.20 | 1.5 +0.20/-0.10 | 3.20±0.40       | 1.00±0.10     |

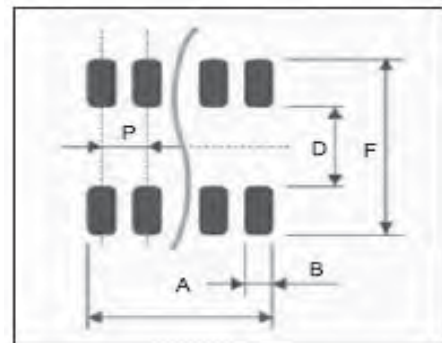

### Footprint Design for 10P8R Network Resistor :

Unit: mm

| Symbol | WT04X               |
|--------|---------------------|
| W1     | 0.50±0.05           |
| W2     | 0.35±0.05           |
| H2     | 0.80±0.10           |
| P1     | 0.70±0.05           |
| P2     | 0.65±0.05           |
| A      | 3.20±0.10           |
| F      | 2.80 + 0.40 / -0.20 |

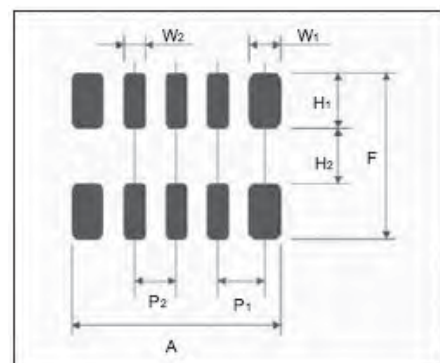

## Storage and Handling Conditions:

1. Products are recommended to be used up within one year. Check solders ability in case shelf life extension is needed.
2. To store products with following condition:  
Temperature : 5 to 40°C  
Humidity : 20 to 70% relative humidity
3. Caution:
  - a. Don't store products in a corrosive environment such as sulfide, chloride gas, or acid. It may cause oxidization of electrode, which easily be resulted in poor soldering
  - b. To store products on the shelf and avoid exposure to moisture.
  - c. Don't expose products to excessive shock, vibration, direct sunlight and so on

## Precaution of Soldering

1. It is recommended to use a mildly activated rosin flux ( less than 0.1% wt chlorine )
2. Excessive flux must be avoided
3. When water-soluble flux is used, enough washing is necessary
4. Two times limitations for reflow soldering is highly recommended
5. Solder repair by soldering iron
  - a. Max. 350°C for below 3 seconds is highly recommended
  - b. Do not directly contact termination to avoid thermal shock.
6. Prevent any external force on the products until solder is cooled

## Mounting

1. Imperfect adjustment of mounting machine may cause the cracks, the chipping and the alignment error. Check and inspect the mounting machine in advance.
2. Set the backup pins in proper layout otherwise the components mounted on the backside of the board are damaged. Do not set these pins at the position of the nozzle.
3. Adjust the bottom dead point of dispenser away from the board when you apply adhesive.
4. Confirm that the products are corresponding to flow soldering when you perform it.
5. Pay attention to the amount of solder because improper amount of solder place large stress on the products and cause cracks or malfunctions.

## Recommendation of Soldering Profiles:

In general application, the lead free (Pb-free) termination CRs are used and may be mounted on PCB by IR reflow or wave soldering process with lead-free solder material. The recommended soldering profiles are shown as Fig.1 & 2.

The lead-free termination CRs are also suitable on SMT process against lead-containing solder paste. But the soldering temperature should be higher than the melting point of solder paste 30°C at least.

If the optimized solder joint is requested, increasing soldering time, temperature and concentration of N<sub>2</sub> within oven are recommended. Advised IR reflow soldering profile is shown as Fig.3.

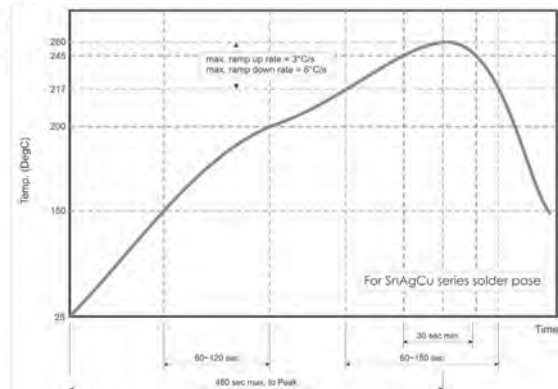

Fig. 1 Recommended IR reflow soldering profile for SMT process with SnAgCu series solder paste.

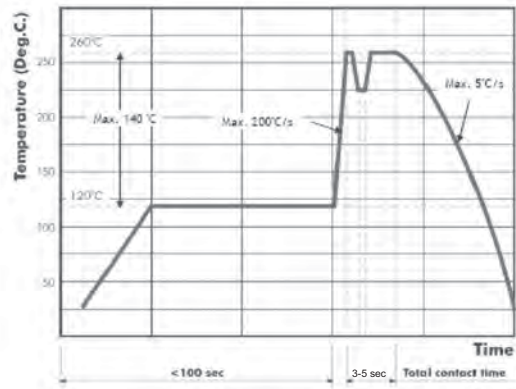

Fig. 2 Recommended wave soldering profile for SMT process with SnAgCu series solder.

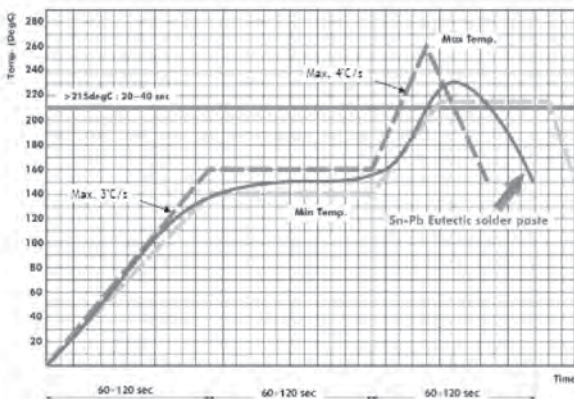

Fig. 3 Recommended reflow soldering profile for SMT process with eutectic SnPb solder paste.

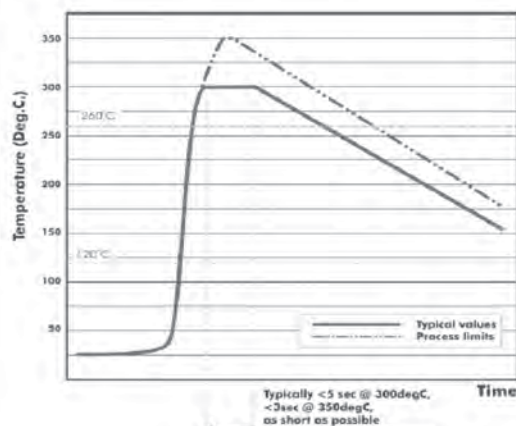

Fig. 4 Recommended soldering profile by manual with SnAgCu series solder.





A series of horizontal dashed lines providing a template for writing a plan and memo.

#### Taiwan - Yang-Mei Plant / Sales Office

Walsin Technology Corporation  
566-1, Kao-Shi Road, Yang-Mei,  
Tao-Yuan, Taiwan  
Tel: +886-3-475-8711  
Fax: +886-3-475-7130  
Email: [info@passivecomponent.com](mailto:info@passivecomponent.com)

#### Taiwan - Kaohsiung Plant

Walsin Technology Corporation  
1st, West 13 Street, K.E.P.Z.  
Kaohsiung, Taiwan  
Tel: +886-7-821-8171  
Fax: +886-7-813-1661  
Email: [info@passivecomponent.com](mailto:info@passivecomponent.com)

#### China - Dalang Plant / Sales Office

Dongguan Walsin Tech. Electronics CO., Ltd.  
Xiniupo Administrative Zone,  
Dalang Town, Dongguan City,  
Guangdong Province 523799  
Tel: +86-769-831-15168  
Fax: +86-769-831-15188  
Email: [stlin@passivecomponent.com](mailto:stlin@passivecomponent.com)

#### China - Suzhou Plant / Sales Office

Suzhou Walsin Technology Electronics Co., Ltd.  
No. 369, Changyan Street,  
Suzhou Industrial Park,  
Jiangsu Province 215126  
Tel: +86-512-628-36888  
Fax: +86-512-628-37888  
Email: [davidcheng@passivecomponent.com](mailto:davidcheng@passivecomponent.com)

#### China - Guangzhou Plant / Sales Office

Pan Overseas (Guangzhou) Electronic Co., Ltd.  
No. 277, Hong Ming Road, Eastern Section,  
Guangzhou Economic and Technology  
Development Zone, China  
Tel: +86-20-8223-7476  
Fax: +86-20-8223-7475  
Email: [info@passivecomponent.com](mailto:info@passivecomponent.com)

#### China - Chongqing Sales Office

Avenue of Stars Yongchuan District No.999  
Chongqing, China  
Tel: +86-769-831-15168 Ext:8509  
Fax: +86-769-831-15188  
Email: [jimmylin@passivecomponent.com](mailto:jimmylin@passivecomponent.com)

#### Germany - Munich Sales Office

Walsin Technology Corporation Europe  
Stefan-George-Ring 29, 81929 Munich, Germany  
Tel: +49-(0)89-9308-6475  
Fax: +49-(0)89-9308-6464  
Email: [aw@passivecomponent.com](mailto:aw@passivecomponent.com)

#### Singapore - Sales Office

WTC Singapore Sales Office, Singapore  
8 Ubi View #04-01 Serial System Building  
Singapore 408554  
Tel: +65-6896-3877  
Fax: +65-6861-3381  
Email: [michaelchee@sg.passivecomponent.com](mailto:michaelchee@sg.passivecomponent.com)

#### United States - West Coast Sales Office

Walsin Technology Corporation, USA  
39500 Stevenson Place Suite 101,  
Fremont, CA 94539, USA  
Tel: +1-214-708-5182  
E-mail: [fctsend@passivecomponent.com](mailto:fctsend@passivecomponent.com)

#### JAPAN - Sales Office

WTC Japan Sales Office, Japan  
8-4-17, Fukayanaka, Ayase-shi,  
Kanagawa, 252-1107, Japan.  
Tel: +81-467-71-0884  
Fax: +81-467-71-0910  
Email: [tsakano@kamaya.co.jp](mailto:tsakano@kamaya.co.jp)



Walsin Technology Corporation

**TAIWAN - WTC Yang-Mei Plant / Sales Office**

Walsin Technology Corporation

566-1, Kao-Shi Road, Yang-Mei, Tao-Yuan, Taiwan

Tel: +886-3-475-8711

Fax: +886-3-475-7130

Email: [info@passivecomponent.com](mailto:info@passivecomponent.com)

**Kaohsiung Plant, Taiwan**

Walsin Technology Corporation

1st, West 13 Street, K.E.P.Z. Kaohsiung, Taiwan

Tel: +886-7-821-8171

Fax: +886-7-813-1661

Email: [info@passivecomponent.com](mailto:info@passivecomponent.com)



January 2013