

大容量積層セラミックコンデンサ HIGH VALUE MULTILAYER CERAMIC CAPACITORS

	code	Temp.characteristics	operating Temp. range
OPERATING TEMP.	BJ	B	-25~+85°C
		X7R	-55~+125°C
		X5R	-55~+85°C
	C	C	-25~+85°C
		X5S	-55~+85°C
		X6S	-55~+105°C
E	E	-25~+85°C	
	Y5U	-30~+85°C	
F	F	-25~+85°C	
	Y5V	-30~+85°C	

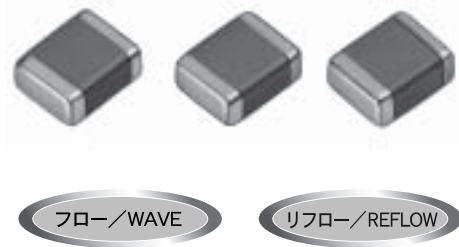

特長 FEATURES

- 電極にNi金属を使用し、端子電極部にメッキをしてあることにより、はんだ付け性および耐熱性にすぐれ、マイグレーションもほとんど発生せず、高い信頼性を示します
- 等価直列抵抗(ESR)が小さく、ノイズ吸収性にすぐれています。特にタンタルおよびアルミ電解コンデンサに比較した場合
- 高い許容リップル電流値
- 高い定格電圧でありながら小型形状
- 絶縁抵抗、破壊電圧が高く信頼性にすぐれる等の特徴があります

- The use of Nickel(Ni) as material for both the internal and external electrodes improves the solderability and heat resistance characteristics. This almost completely eliminates migration and raises the level of reliability significantly.
- Low equivalent series resistance(ESR) provides excellent noise absorption characteristics.
- Compared to tantalum or aluminum electrolytic capacitors these ceramic capacitors offer a number of excellent features, including:
Higher permissible ripple current values
Smaller case sizes relative to rated voltage
Improved reliability due to higher insulation resistance and breakdown voltage.

用途 APPLICATIONS

- デジタル回路全般
- 電源バイパスコンデンサ
液晶モジュール用
液晶駆動電圧ライン用
電源電圧の高いLSI、IC、OPアンプ用
- 平滑コンデンサ
DC-DCコンバータ(入力、出力側用)
スイッチング電源(2次側用)

- General digital circuit
- Power supply bypass capacitors
Liquid crystal modules
Liquid crystal drive voltage lines
LSI, IC, converters(both for input and output)
- Smoothing capacitors
DC-DC converters (both for input and output)
Switching power supplies (secondary side)

形名表記法 ORDERING CODE

1 定格電圧 (VDC)	
A	4
J	6.3
L	10
E	16
T	25
G	35
U	50

2 シリーズ名	
M	積層コンデンサ

3 端子電極	
K	メッキ品

4 形状寸法 (EIA)L×W(mm)	
107(0603)	1.6×0.8
212(0805)	2.0×1.25
316(1206)	3.2×1.6
325(1210)	3.2×2.5
432(1812)	4.5×3.2

5 温度特性 (%)	
△F	± ³⁰ / ₈₀
△C	±20
△E	± ²⁰ / ₈₅
BJ	±10

△=スペース

6 公称静電容量 (pF)	
例	
473	47,000
105	1,000,000

7 容量許容差	
K	±10 %
M	±20 %
Z	± ⁸⁰ / ₂₀ %

8 製品厚み (mm)	
A	0.8
D	0.85
F	1.15
G	1.25
H	1.5
L	1.6
N	1.9
Y	2.0max
M	2.5
U	3.2

9 個別仕様	
-	標準

10 包装	
B	単品(袋づめ)
T	リールテーピング

11 当社管理記号	
△	標準品

△=スペース



1 Rated voltage(VDC)	
A	4
J	6.3
L	10
E	16
T	25
G	35
U	50

2 Series name	
M	Multilayer Ceramic Capacitors

3 End termination	
K	Plated

4 Dimensions(case size)(mm)	
107(0603)	1.6×0.8
212(0805)	2.0×1.25
316(1206)	3.2×1.6
325(1210)	3.2×2.5
432(1812)	4.5×3.2

5 Temperature characteristics code	
△F	Y5V -30~+85°C +22/-82%
BJ	X7R -55~+125°C ±15%
BJ	X5R -55~+85°C ±15%
△C	X5S -55~+85°C ±22%
△C	X6S -55~+105°C ±22%
△E	Y5U -30~+85°C ±22% / -56%

△=Blank space

6 Nominal capacitance(pF)	
example	
473	47,000
105	1,000,000

7 Capacitance tolerances(%)	
K	±10
M	±20
Z	± ⁸⁰ / ₂₀

8 Thickness(mm)	
A	0.8
D	0.85
F	1.15
G	1.25
H	1.5
L	1.6
N	1.9
Y	2.0max
M	2.5
U	3.2

9 Special code	
-	Standard products

10 Packaging	
B	Bulk
T	Tape & reel

11 Internal code	
△	Standard products

△=Blank space

■107TYPE

定格電圧 Rated Voltage	形名 Ordering code	公称静電容量 Capacitance [μF]	温度特性 Temperature characteristics	tan δ Dissipation factor [%]Max.	実装条件 Soldering method R:リフロー Reflow soldering W:フロー Wave soldering	静電容量許容差 Capacitance tolerance	厚み Thickness [mm] (inch)	
35V	GMK107BJ333□A	0.033	B/X5R	3.5	R/W	±10% ±20%	0.8±0.1	
	GMK107BJ473□A	0.047	B/X5R	3.5			0.8±0.1	
	TMK107BJ223□A	0.022	B/X7R	2.5			0.8±0.1	
25V	TMK107BJ683□A	0.068	B/X5R	3.5			0.8±0.1	
	TMK107BJ104□A	0.1	B/X5R	3.5			0.8±0.1	
	16V	EMK107BJ333□A	0.033	B/X7R			3.5	0.8±0.1
		EMK107BJ473□A	0.047	B/X7R			3.5	0.8±0.1
EMK107BJ683□A		0.068	B/X7R	3.5			0.8±0.1	
EMK107BJ104□A		0.1	B/X7R	3.5			0.8±0.1	
10V	EMK107BJ154□A	0.15	B/X5R	3.5			0.8±0.1	
	EMK107BJ224□A	0.22	B/X5R	3.5			0.8±0.1	
	LMK107BJ334□A	0.33	B/X5R	3.5			0.8±0.1	
	6.3V	LMK107BJ474□A	0.47	B/X5R			3.5	R
LMK107BJ684□A		0.68	B/X5R	5			0.8±0.1	
LMK107BJ105□A		1	B/X5R	5			0.8±0.1	
4V	JMK107BJ474□K	0.47	B/X5R	5			0.45±0.05	
	JMK107BJ225□A*	2.2	B/X5R	10	0.8±0.1			
25V	AMK107BJ475MA*	4.7	B/X5R	10	0.8±0.1			
16V	TMK107C105□A	1	C/X5S	10	R	±20%	0.8±0.1	
	EMK107F224ZA	0.22	F/Y5V	7	R/W	+80% -20%	0.8±0.1	
EMK107F474ZA	0.47	F/Y5V	7	0.8±0.1				
10V	LMK107F105ZA	1	F/Y5V	16	R		0.8±0.1	
6.3V	JMK107F105ZK	1	F/Y5V	16			0.45±0.05	
	JMK107F225ZA	2.2	F/Y5V	16	0.8±0.1			

■212TYPE

定格電圧 Rated Voltage	形名 Ordering code	公称静電容量 Capacitance [μF]	温度特性 Temperature characteristics	tan δ Dissipation factor [%]Max.	実装条件 Soldering method R:リフロー Reflow soldering W:フロー Wave soldering	静電容量許容差 Capacitance tolerance	厚み Thickness [mm] (inch)	
50V	UMK212BJ223□D	0.022	B/X7R	2.5	R/W	±10% ±20%	0.85±0.1	
	UMK212BJ333□D	0.033	B/X7R	2.5			0.85±0.1	
	UMK212BJ473□G	0.047	B/X7R	2.5			1.25±0.1	
	UMK212BJ683□G	0.068	B/X7R	2.5			1.25±0.1	
	UMK212BJ104□G	0.1	B/X7R	2.5			1.25±0.1	
	UMK212BJ154□G	0.15	B/X7R	3.5			1.25±0.1	
35V	UMK212BJ224□G	0.22	B/X5R	3.5			1.25±0.1	
	GМК212BJ334□G	0.33	B/X7R	3.5			1.25±0.1	
25V	GМК212BJ474□G	0.47	B/X5R	3.5			1.25±0.1	
	TMK212BJ473□D	0.047	B/X7R	2.5			0.85±0.1	
16V	TMK212BJ683□D	0.068	B/X7R	2.5			R	0.85±0.1
	EMK212BJ474□D	0.47	B/X7R	3.5				0.85±0.1
	EMK212BJ684□D	0.68	B/X7R	3.5	0.85±0.1			
	EMK212BJ684□G	0.68	B/X7R	3.5	1.25±0.1			
	EMK212BJ105□G	1	B/X5R	3.5	1.25±0.1			
	EMK212BJ105□D	1	B/X5R	5	0.85±0.1			
10V	EMK212BJ155□D	1.5	B/X5R	5	R/W	0.85±0.1		
	LMK212BJ224□K	0.22	B/X5R	3.5		0.45±0.05		
	LMK212BJ105□D	1	B/X7R	3.5		0.85±0.1		
	LMK212BJ105□G	1	B/X7R	3.5		1.25±0.1		
6.3V	LMK212BJ225□G	2.2	B/X5R	5	R	1.25±0.15		
	LMK212BJ335□G	3.3	B/X5R	5		0.45±0.05		
	JMK212BJ105□K	1	B/X5R	5		0.85±0.1		
	JMK212BJ475□D	4.7	B/X5R	10		1.25±0.15		
	JMK212BJ475□G	4.7	B/X5R	5		1.25±0.15		
	JMK212BJ106□G*	10	B/X5R	10		1.25±0.15		
10V	LMK212C106□G*	10	C/X5S	10	R/W	1.25±0.15		
	UMK212F224ZD	0.22	F/Y5V	7		0.85±0.1		
50V	UMK212F474ZG	0.47	F/Y5V	7	R	1.25±0.1		
	UMK212F105ZG	1	F/Y5V	7		1.25±0.1		
16V	EMK212F225ZG	2.2	F/Y5V	7	+80% -20%	1.25±0.1		
	LMK212F225ZG	2.2	F/Y5V	9		1.25±0.1		
10V	LMK212F475ZG	4.7	F/Y5V	9	R	1.25±0.1		
	LMK212F106ZG	10	F/Y5V	16		1.25±0.1		
6.3V	JMK212F475ZD	4.7	F/Y5V	16		0.85±0.1		

■316TYPE

定格電圧 Rated Voltage	形名 Ordering code	公称静電容量 Capacitance [μF]	温度特性 Temperature characteristics	tan δ Dissipation factor [%]Max.	実装条件 Soldering method R:リフロー Reflow soldering W:ワロー Wave soldering	静電容量許容差 Capacitance tolerance	厚み Thickness [mm] (inch)
50V	UMK316BJ154□F	0.15	B/X7R	2.5	R/W	±10% ±20%	1.15±0.1
	UMK316BJ224□L	0.22	B/X7R	2.5			1.6±0.2
	UMK316BJ474□L	0.47	B/X7R	3.5			1.6±0.2
35V	GMK316BJ684□L	0.68	B/X7R	3.5			1.6±0.2
	GMK316BJ105□L	1	B/X7R	3.5			1.6±0.2
25V	TMK316BJ154□D	0.15	B/X7R	2.5			0.85±0.1
	TMK316BJ224□F	0.22	B/X7R	2.5			1.15±0.1
	TMK316BJ334□F	0.33	B/X7R	2.5			1.15±0.1
	TMK316BJ684□L	0.68	B/X7R	3.5			1.6±0.2
16V	EMK316BJ155□D	1.5	B/X5R	3.5			R
	EMK316BJ225□D	2.2	B/X5R	3.5	0.85±0.1		
	EMK316BJ684□F	0.68	B/X7R	3.5	R/W	1.15±0.1	
	EMK316BJ105□F	1	B/X7R	3.5		1.15±0.1	
	EMK316BJ225□L	2.2	B/X7R	3.5	1.6±0.2		
	EMK316BJ335□L	3.3	B/X5R	3.5	1.6±0.2		
10V	EMK316BJ475□L	4.7	B/X5R	3.5	R	1.6±0.2	
	LMK316BJ335□D	3.3	B/X5R	5		0.85±0.1	
	LMK316BJ335□L	3.3	B/X7R	3.5		1.6±0.2	
6.3V	LMK316BJ475□L	4.7	B/X7R	3.5		1.6±0.2	
	JMK316BJ106□D*	10	B/X5R	10		0.85±0.1	
	JMK316BJ106□L	10	B/X7R	5		1.6±0.2	
25V	JMK316BJ226□L*	22	B/X5R	10	1.6±0.2		
	TMK316C106□L	10	C/X5S	10	1.6±0.2		
50V	UMK316F225ZG	2.2	F/Y5V	7	R/W	1.25±0.1	
35V	GMK316F475ZG	4.7	F/Y5V	7	R	1.25±0.1	
16V	EMK316F106ZL	10	F/Y5V	9		1.6±0.2	
10V	LMK316F475ZD	4.7	F/Y5V	9		0.85±0.1	
	LMK316F106ZF	10	F/Y5V	16		1.15±0.1	
	LMK316F226ZL	22	F/Y5V	16		1.6±0.2	
6.3V	JMK316F106ZD	10	F/Y5V	16		0.85±0.1	

■325TYPE

定格電圧 Rated Voltage	形名 Ordering code	公称静電容量 Capacitance [μF]	温度特性 Temperature characteristics	tan δ Dissipation factor [%]Max.	実装条件 Soldering method R:リフロー Reflow soldering W:フロー Wave soldering	静電容量許容差 Capacitance tolerance	厚み Thickness [mm] (inch)
50V	UMK325BJ105□□H	1	B/X7R	3.5	R/W	±10%±20%	1.5±0.1
35V	GMK325BJ225MN	2.2	B/X5R	3.5	R	±20%	1.9±0.2
25V	TMK325BJ105MD	1	B/X7R	3.5			0.85±0.1
	TMK325BJ225MH	2.2	B/X7R	3.5			1.5±0.1
	TMK325BJ335MN	3.3	B/X7R	3.5			1.9±0.2
	TMK325BJ475MN	4.7	B/X5R	3.5			1.9±0.2
	TMK325BJ106MM*	10	B/X5R	3.5			2.5±0.2
	EMK325BJ475MN	4.7	B/X7R	3.5			1.9±0.2
16V	EMK325BJ106MN	10	B/X5R	3.5			1.9±0.2
	EMK325BJ226MM*	22	B/X5R	5			2.5±0.2
10V	LMK325BJ335MD	3.3	B/X5R	3.5			0.85±0.1
	LMK325BJ106MN	10	B/X7R	3.5			1.9±0.2
	LMK325BJ226MM	22	B/X5R	5			2.5±0.2
	LMK325BJ475MD	4.7	B/X5R	5			0.85±0.1
6.3V	JMK325BJ685MD	6.8	B/X5R	5			0.85±0.1
	JMK325BJ106MD	10	B/X5R	5			0.85±0.1
	JMK325BJ226MY	22	B/X5R	5			1.9+0.1/-0.2
	JMK325BJ226MM	22	B/X5R	5	2.5±0.2		
	JMK325BJ476MM*	47	B/X5R	10	2.5±0.2		
	JMK325E107ZM*	100	E/Y5U	16	2.5±0.2		
50V	UMK325F475ZH	4.7	F/Y5V	9	R	+80% -20%	1.5±0.1
35V	GMK325F106ZH	10	F/Y5V	7			1.5±0.1
10V	LMK325F226ZN	22	F/Y5V	16			1.9±0.2
6.3V	JMK325F476ZN	47	F/Y5V	16			1.9±0.2
	JMK325F107ZM*	100	F/Y5V	16			2.5±0.2

■432TYPE

定格電圧 Rated Voltage	形名 Ordering code	公称静電容量 Capacitance [μF]	温度特性 Temperature characteristics	tan δ Dissipation factor [%]Max.	実装条件 Soldering method R:リフロー Reflow soldering W:フロー Wave soldering	静電容量許容差 Capacitance tolerance	厚み Thickness [mm] (inch)
25V	TMK432BJ106MM	10	B/X5R	3.5	R	±20%	2.5±0.2
16V	EMK432BJ226MM*	22	B/X5R	3.5			2.5±0.2
10V	LMK432BJ226MM	22	B/X5R	3.5			2.5±0.2
6.3V	JMK432BJ476MM*	47	B/X5R	5			2.5±0.2
	JMK432BJ107MU*	100	B/X5R	10			3.2±0.3
	JMK432C107MM*	100	C/X6S	10			2.5±0.2
	JMK432C107MY*	100	C/X5S	10	1.9+0.1/-0.2		
10V	LMK432F476ZM*	47	F/Y5V	16	R	+80% -20%	2.5±0.2
6.3V	JMK432F107ZM*	100	F/Y5V	16			2.5±0.2

形名の□には静電容量許容差記号が入ります。

□ Please specify the capacitance tolerance code.

*高温負荷試験の試験電圧は定格電圧の1.5倍

* Test Voltage of Loading at high temperature test is 1.5 time of the rated voltage.

特性図 ELECTRICAL CHARACTERISTICS

インピーダンス・ESR-周波数特性例 Example of Impedance ESR vs. Frequency characteristics
 ・当社積層セラミックコンデンサ例 (Taiyo Yuden multilayer ceramic capacitor)

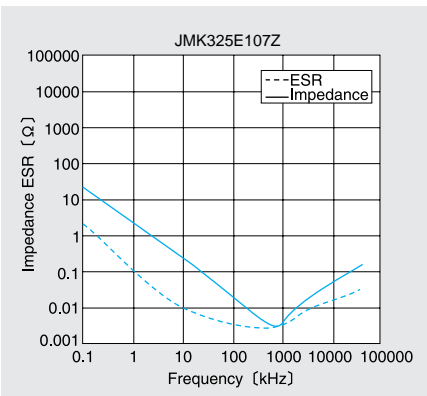
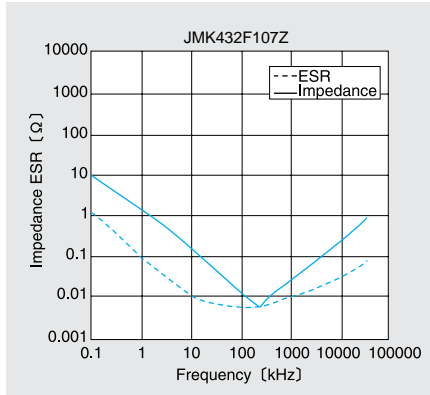
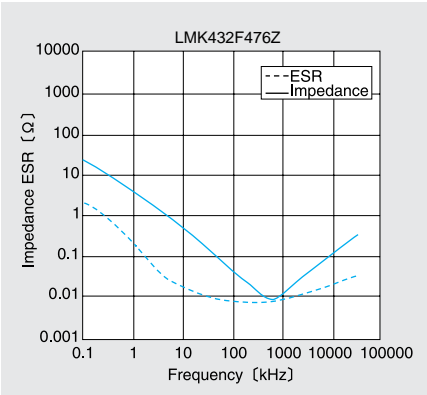
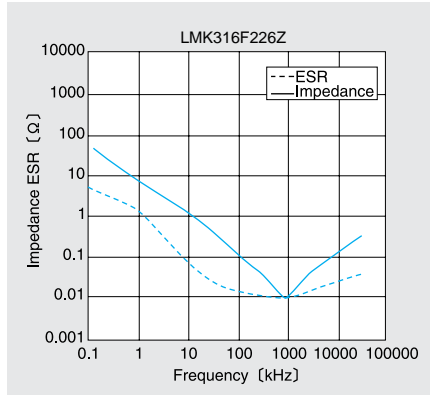
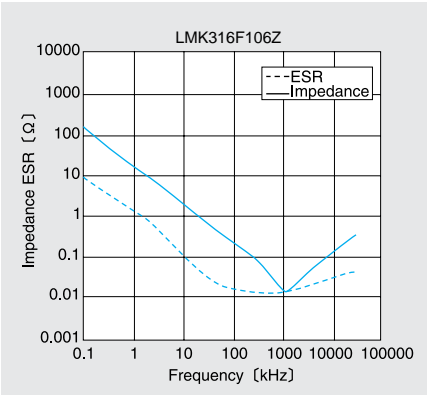
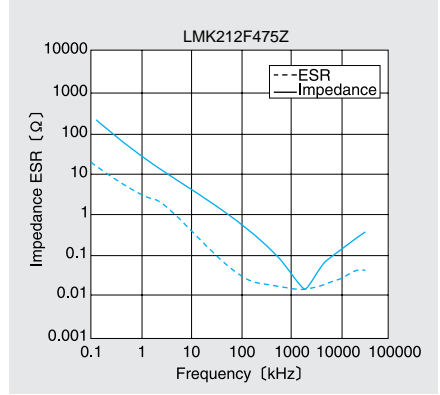
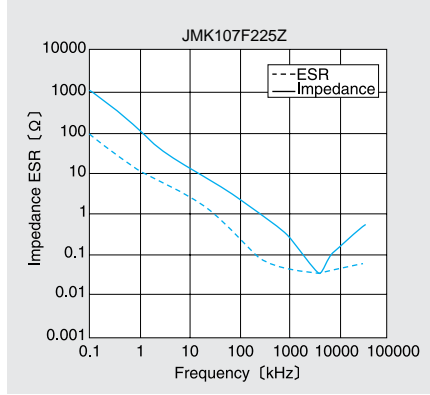
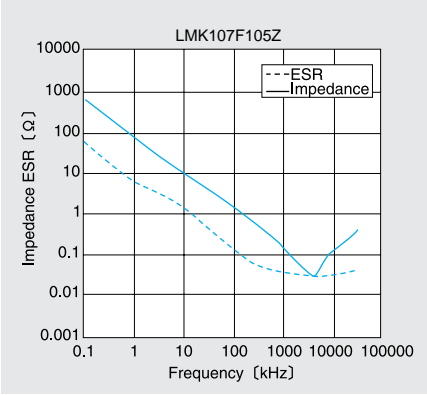

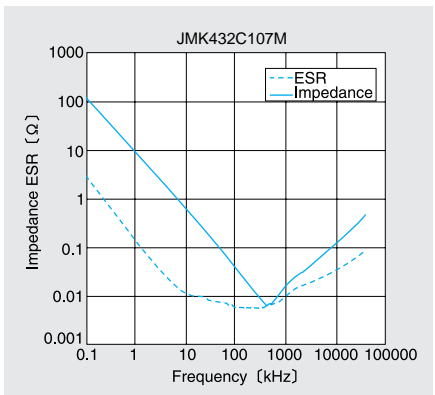
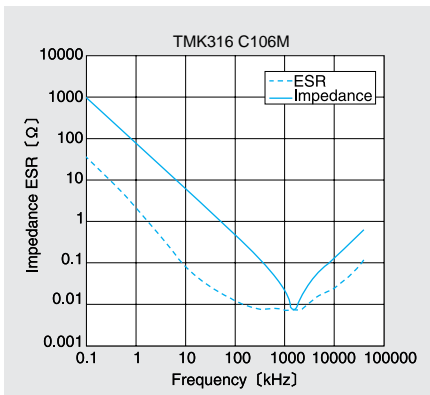
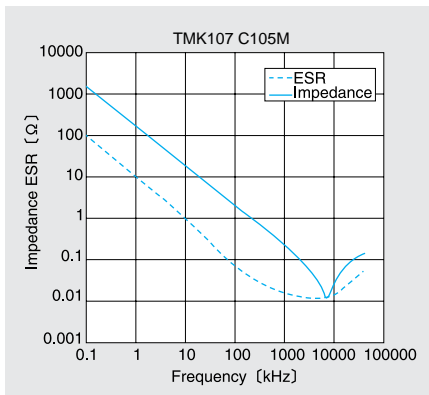
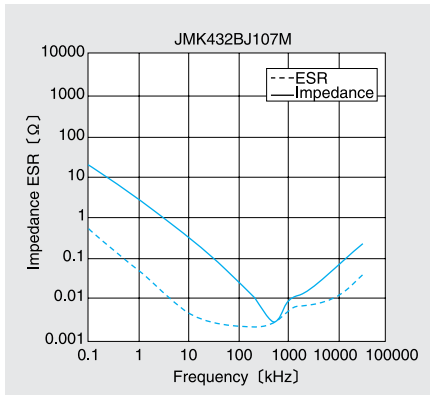
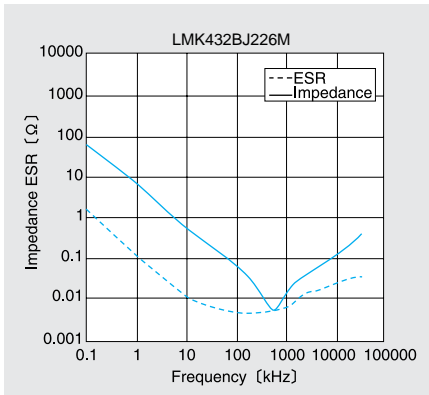
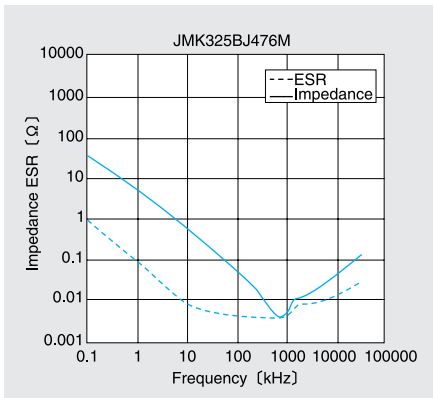
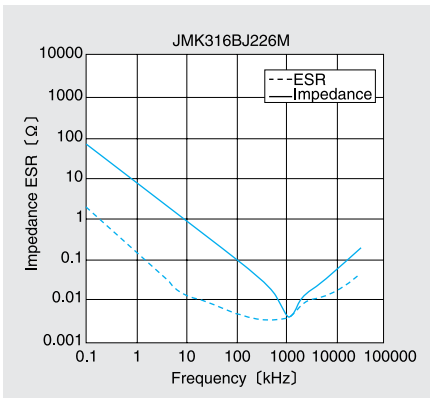
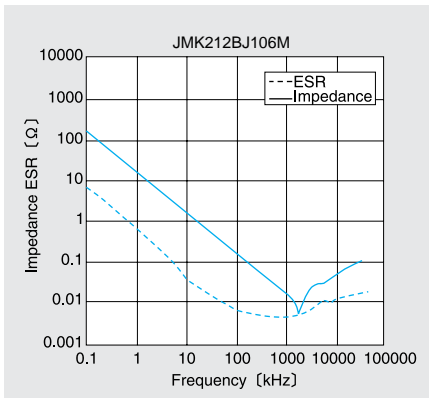
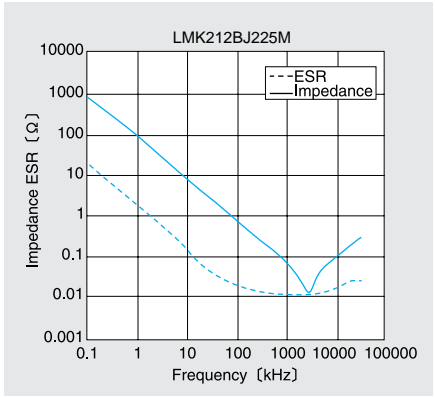
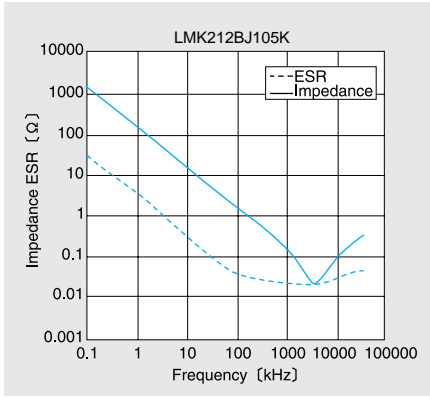
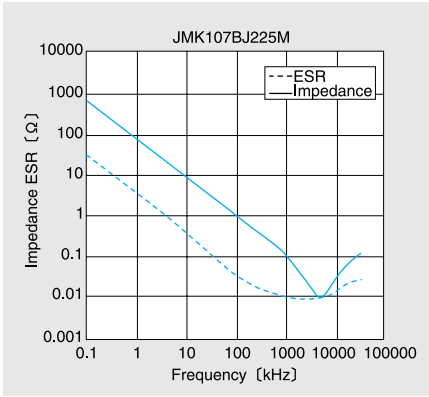

一般積層セラミックコンデンサ (温度補償用・Class 1) STANDARD MULTILAYER CERAMIC CAPACITORS (CLASS1 : TEMPERATURE COMPENSATING DIELECTRIC TYPE)

OPERATING TEMP. -55~+125°C



特長 FEATURES

- ・実装密度の向上が図れます
- ・モノリシックの構造のため、信頼性が高い
- ・同一形状、静電容量範囲が広い

- ・ Improve Higher Mounting Densities.
- ・ Multilayer block structure provides higher reliability
- ・ A wide range of capacitance values available in standard case sizes.

用途 APPLICATIONS

- ・一般電子機器用
- ・通信機器用 (携帯電話、PHS、コードレス電話 etc.)

- ・ General electronic equipment
- ・ Communication equipment (portable telephones, PHS, other wireless applications, etc.)

形名表記法 ORDERING CODE

1 定格電圧 (VDC)	4 形状寸法 (EIA) L×W (mm)	6 公称静電容量 (pF)	7 容量許容差	9 個別仕様
E 16 T 25 U 50	063(0201) 0.6×0.3 105(0402) 1.0×0.5 107(0603) 1.6×0.8	例 0R5 0.5 010 1 100 10 ※R=小数点	C ± 0.25 pF D ± 0.5 pF F ± 1 pF J ± 5 % K ± 10 %	— 標準
2 シリーズ名	5 温度特性 (ppm/°C)	8 製品厚み (mm)	10 包装	11 当社管理記号
M 積層コンデンサ	C□ 0 : CG, CH, CJ, CK P□ -150 : PH, PJ, PK R□ -220 : RH, RJ, RK S□ -330 : SH, SJ, SK G ± 30 T□ -470 : TH, TJ, TK H ± 60 U□ -750 : UJ, UK J ± 120 S L +350~-1000 K ± 250 □=許容差	P 0.3 W 0.5 Z 0.8	B 単品(袋詰め) F テーピング(2mmピッチ・178φ) T テーピング(4mmピッチ・178φ)	△ 標準品 △=スペース

U M K 1 0 5 C H 1 0 1 J W - F ○

1 2 3 4 5 6 7 8 9 10 11

1 Rated voltage (VDC)	4 Dimensions (case size) (EIA) L×W (mm)	6 Nominal Capacitance (pF)	7 Capacitance Tolerance	9 Special code
E 16 T 25 U 50	063(0201) 0.6×0.3 105(0402) 1.0×0.5 107(0603) 1.6×0.8	example 0R5 0.5 010 1 100 10 *R=decimal point	C ± 0.25 pF D ± 0.5 pF F ± 1 pF J ± 5 % K ± 10 %	— Standard Products
2 Series name	5 Temperature characteristics (ppm/°C)	8 Thickness (mm)	10 Packaging	11 Internal code
M Multilayer ceramic capacitor	C□ 0 : CG, CH, CJ, CK (C0G, C0H, C0J, C0K) P□ -150 : PH, PJ, PK (P2H, P2J, P2K) R□ -220 : RH, RJ, RK (R2H, R2J, R2K) S□ -330 : SH, SJ, SK (S2H, S2J, S2K) 2 ± 30 T□ -470 : TH, TJ, TK (T2H, T2J, T2K) H ± 60 U□ -750 : UJ, UK 2J ± 120 S L +350~-1000 K ± 250 □=Tolerance	P 0.3 W 0.5 Z 0.8	B Bulk F Tape (2mm pitch・178φ) T Tape (4mm pitch・178φ)	△ Standard Products △=Blank space

外形寸法 EXTERNAL DIMENSIONS

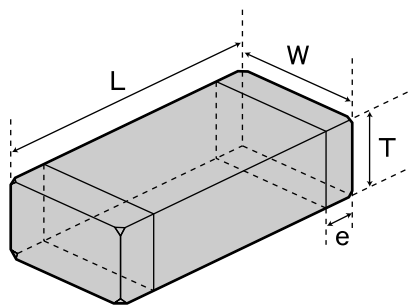

Type(EIA)	L	W	T		e
□MK063 (0201)	0.6±0.03 (0.024±0.001)	0.3±0.03 (0.012±0.001)	0.3±0.03 (0.012±0.001)	P	0.15±0.05 (0.006±0.002)
□MK105 (0402)	1.0±0.05 (0.039±0.002)	0.5±0.05 (0.020±0.002)	0.5±0.05 (0.020±0.002)	W	0.25±0.10 (0.010±0.004)
□MK107 (0603)	1.6±0.10 (0.063±0.004)	0.8±0.10 (0.031±0.004)	0.8±0.10 (0.031±0.004)	Z	0.35±0.25 (0.014±0.010)

Unit : mm(inch)

概略バリエーション AVAILABLE CAPACITANCE RANGE

Type	063				105				107			
Temp.char.	C□	R□	S□	T□	U□	C□	SL	C□	RC□	U□	SL	
WV	25 V		16 V		50 V	50 V	50 V					
[pF]	[pF 3digits]											
0.5	OR5											
1	010											
1.5	1R5											
2	020											
3	030											
4	040											
5	050											
6	060	P										
7	070		W									
8	080		W	W								
9	090		W	W								
10	100											
12	120											
15	150											
18	180											
22	220											
27	270											
33	330											
39	390											
47	470											
56	560											
68	680											
82	820											
100	101											
120	121											
150	151											
180	181											
220	221											
270	271											
330	331											
390	391											
470	471											
560	561											
680	681											
820	821											
1000	102											

注：グラフの記号は製品の厚み記号です。
Note: Letter code in shaded areas are thickness codes.

温度特性 Temperature Characteristics

温度特性 Temperature char.(EIA)	温度係数範囲 [ppm/°C] ※1 Temperature coefficient range	使用温度範囲 Operating Temp. range
C K(C0K)	0±250	-55~+125°C
C J(C0J)	0±120	
C H(C0H)	0±60	
C G(C0G)	0±30	
P K(P2K)	-150±250	
P J(P2J)	-150±120	
P H(P2H)	-150±60	
R K(R2K)	-220±250	
R J(R2J)	-220±120	
R H(R2H)	-220±60	
S K(S2K)	-330±250	
S J(S2J)	-330±120	
S H(S2H)	-330±60	
T K(T2K)	-470±250	
T J(T2J)	-470±120	
T H(T2H)	-470±60	
U K(U2K)	-750±250	
U J(U2J)	-750±120	
S L	-1000~+350	

※1：20°Cにおける静電容量を基準。
Based on the capacitance at 20°C

静電容量許容差 Capacitance Tolerance Symbol

記号 Symbol	許容差 Tolerance	区分 Item
C	±0.25pF	~5pF
D	±0.5 pF	~10pF
F	±1pF	6~10 pF
J	±5 %	11pF~
K	±10 %	11pF~

Q

Q※2 Symbol	区分 Item
≥400+20・C※1	~27pF
≥1000	30pF~

※1：C=公称静電容量 Nominal capacitance(pF)

※2：測定周波数 Measurement Frequency= 1±0.1MHz(C≤1000pF)

1±0.1kHz (C>1000pF)

測定電圧 Measurement voltage = 0.5~5Vrms(C≤1000pF)

1±0.2Vrms(C>1000pF)

セレクションガイド
Selection Guide

アイテム一覧
Part Numbers

特性図
Electrical Characteristics

梱包
Packaging

信頼性
Reliability Data

使用上の注意
Precautions



etc

063TYPE

Class 1

定格電圧 Rated Voltage (DC)	形名 Ordering code	温度特性 Temperature characteristics (EIA)														公称静電容量 Capacitance [pF]	静電容量許容差 Capacitance tolerance [%]	厚み Thickness [mm] (inch)					
		CK (CK)	CJ (CJ)	CH (CH)	CG (CG)	PK (PK)	PJ (PJ)	PH (PH)	RK (RK)	RJ (RJ)	RH (RH)	SK (SK)	SJ (SJ)	SH (SH)	TK (TK)				TJ (TJ)	TH (TH)	UK (UK)	UJ (UJ)	SL
25V	TMK 063 CK 0R5□P	●			●																0.5	±0.25pF ±0.5pF	0.3±0.03 (0.012±0.001)
	TMK 063 CK 010□P	●			●																1		
	TMK 063 CK 1R5□P	●			●																1.5		
	TMK 063 CK 020□P	●			●																2		
	TMK 063 CJ 030□P		●		●																3		
	TMK 063 CH 040□P			●	●																4		
	TMK 063 CH 050□P			●	●																5		
	TMK 063 CH 060□P			●	●																6		
	TMK 063 CH 070□P			●	●																7		
	TMK 063 CH 080□P			●	●																8		
	TMK 063 CH 090□P			●	●																9		
	TMK 063 CH 100□P			●	●																10		
	TMK 063 CH 120□P			●	●																12		
	TMK 063 CH 150□P			●	●																15		
	TMK 063 CH 180□P			●	●																18		
	TMK 063 CH 220□P			●	●																22		
	TMK 063 CH 270□P			●	●																27		
	TMK 063 CH 330□P			●	●																33		
	TMK 063 CH 390□P			●	●																39		
	TMK 063 CH 470□P			●	●																47		
TMK 063 CH 560□P			●	●																56			
TMK 063 CH 680□P			●	●																68			
TMK 063 CH 820□P			●	●																82			
TMK 063 CH 101□P			●	●																100			

注：形名の□には静電容量許容差記号が入ります。
△ Please specify the capacitance tolerance code.

105TYPE

Class 1

定格電圧 Rated Voltage (DC)	形名 Ordering code	温度特性 Temperature characteristics (EIA)														公称静電容量 Capacitance [pF]	静電容量許容差 Capacitance tolerance [%]	厚み Thickness [mm] (inch)					
		CK (CK)	CJ (CJ)	CH (CH)	CG (CG)	PK (PK)	PJ (PJ)	PH (PH)	RK (RK)	RJ (RJ)	RH (RH)	SK (SK)	SJ (SJ)	SH (SH)	TK (TK)				TJ (TJ)	TH (TH)	UK (UK)	UJ (UJ)	SL
50V	UMK 105 CK 0R5□W	●			●																0.5	±0.25pF ±0.5pF	0.5±0.05 (0.020±0.002)
	UMK 105 CK 010□W	●			●																1		
	UMK 105 CK 1R5□W	●			●																1.5		
	UMK 105 CK 020□W	●			●																2		
	UMK 105 CJ 030□W		●		●																3		
	UMK 105 CH 040□W			●	●																4		
	UMK 105 CH 050□W			●	●																5		
	UMK 105 CH 060□W			●	●																6		
	UMK 105 CH 070□W			●	●																7		
	UMK 105 CH 080□W			●	●																8		
	UMK 105 CH 090□W			●	●																9		
	UMK 105 CH 100□W			●	●																10		
	UMK 105 CH 120□W			●	●																12		
	UMK 105 CH 150□W			●	●																15		
	UMK 105 CH 180□W			●	●																18		
	UMK 105 CH 220□W			●	●																22		
	UMK 105 CH 270□W			●	●																27		
	UMK 105 CH 330□W			●	●																33		
	UMK 105 CH 390□W			●	●																39		
	UMK 105 CH 470□W			●	●																47		
	UMK 105 CH 560□W			●	●																56		
	UMK 105 CH 680□W			●	●																68		
	UMK 105 CH 820□W			●	●																82		
	UMK 105 CH 101□W			●	●																100		
	UMK 105 CH 121□W			●	●																120		
	UMK 105 CH 151□W			●	●																150		
	UMK 105 CH 181□W			●	●																180		
	UMK 105 CH 221□W			●	●																220		
	UMK 105 CH 271□W			●	●																270		
	UMK 105 SL 121□W																			●	120		
UMK 105 SL 151□W																			●	150			
UMK 105 SL 181□W																			●	180			
UMK 105 SL 221□W																			●	220			
UMK 105 SL 271□W																			●	270			
UMK 105 SL 331□W																			●	330			

注：形名の□には静電容量許容差記号が入ります。
△ Please specify the capacitance tolerance code.

105TYPE

Class 1

定格電圧 Rated Voltage (DC)	形名 Ordering code	温度特性 Temperature characteristics (EIA)														公称静電容量 Capacitance [pF]	静電容量許容差 Capacitance tolerance [%]	厚み Thickness [mm] (inch)					
		CK (CK)	CJ (CJ)	CH (CH)	CG (CG)	PK (PK)	PJ (PJ)	PH (PH)	RK (RK)	RJ (RJ)	RH (RH)	SK (SK)	SJ (SJ)	SH (SH)	TK (TK)				TJ (TJ)	TH (TH)	UK (UK)	UJ (UJ)	SL
16V	EMK105△ 0 R 5 B W											●			●			●			0.5	±0.1pF	0.5±0.05 (0.020±0.002)
	EMK105△ 0 1 0 B W											●			●			●			1		
	EMK105△ 1 R 2 B W											●			●			●			1.2		
	EMK105△ 1 R 5 B W											●			●			●			1.5		
	EMK105△ 1 R 8 B W											●			●			●			1.8		
	EMK105△ 2 R 2 J W											●			●			●			2.2		
	EMK105△ 2 R 7 J W											●			●			●			2.7		
	EMK105△ 3 R 3 J W												●		●			●			3.3		
	EMK105△ 3 R 9 J W												●		●			●			3.9		
	EMK105△ 4 R 7 J W													●		●			●		4.7		
	EMK105△ 5 R 6 J W										●			●		●			●		5.6		
	EMK105△ 6 R 8 J W										●			●		●			●		6.8		
	EMK105△ 8 R 2 J W										●			●		●			●		8.2		
	EMK105△ 1 0 0 J W										●			●		●			●		10		
	EMK105△ 1 2 0 J W										●			●		●			●		12		
	EMK105△ 1 5 0 J W										●			●		●			●		15		
	EMK105△ 1 8 0 J W										●			●		●			●		18		
EMK105△ 2 0 0 J W										●			●		●			●		20			

注：形名の△には温度特性、□には静電容量許容差記号が入ります。
 △ Please specify the temperature characteristics code and □ the capacitance tolerance code.

107TYPE

Class 1

定格電圧 Rated Voltage (DC)	形名 Ordering code	温度特性 Temperature characteristics (EIA)														公称静電容量 Capacitance [pF]	静電容量許容差 Capacitance tolerance [%]	厚み Thickness [mm] (inch)						
		CK (C0K)	CJ (C0J)	CH (C0H)	CG (C0G)	PK (P2K)	PJ (P2J)	PH (P2H)	RK (R2K)	RJ (R2J)	RH (R2H)	SK (S2K)	SJ (S2J)	SH (S2H)	TK (T2K)				TJ (T2J)	TH (T2H)	UK (U2K)	UJ (U2J)	SL	
50V	UMK 107 △ 0R5□Z	●				●			●			●			●			●		●	0.5	±0.25pF ±0.5 pF	0.8±0.10 (0.031±0.004)	
	UMK 107 △ 010□Z	●				●			●			●			●			●		●	1			
	UMK 107 △ 1R5□Z	●				●			●			●			●			●		●	1.5			
	UMK 107 △ 020□Z	●				●			●			●			●			●		●	2			
	UMK 107 △ 030□Z		●				●			●			●			●			●		●			3
	UMK 107 △ 040□Z			●					●			●			●			●		●	4			
	UMK 107 △ 050□Z				●				●			●			●			●		●	5			
	UMK 107 △ 060□Z				●				●			●			●			●		●	6			
	UMK 107 △ 070□Z				●				●			●			●			●		●	7			
	UMK 107 △ 080□Z				●				●			●			●			●		●	8			
	UMK 107 △ 090□Z				●				●			●			●			●		●	9			
	UMK 107 △ 100□Z				●	●			●			●			●			●		●	10			
	UMK 107 △ 120□Z				●	●			●			●			●			●		●	12			
	UMK 107 △ 150□Z				●	●			●			●			●			●		●	15			
	UMK 107 △ 180□Z				●	●			●			●			●			●		●	18			
	UMK 107 △ 220□Z				●	●			●			●			●			●		●	22			
	UMK 107 △ 270□Z				●	●			●			●			●			●		●	27			
	UMK 107 △ 330□Z				●	●			●			●			●			●		●	33			
	UMK 107 △ 390□Z				●	●			●			●			●			●		●	39			
	UMK 107 △ 470□Z				●	●			●			●			●			●		●	47			
	UMK 107 △ 560□Z				●	●			●			●			●			●		●	56			
	UMK 107 △ 680□Z				●	●			●			●			●			●		●	68			
	UMK 107 △ 820□Z				●	●			●			●			●			●		●	82			
	UMK 107 △ 101□Z				●	●			●			●			●			●		●	100			
	UMK 107 △ 121□Z				●	●			●			●			●			●		●	120			
	UMK 107 △ 151□Z				●	●			●			●			●			●		●	150			
	UMK 107 △ 181□Z				●	●			●			●			●			●		●	180			
	UMK 107 △ 221□Z				●	●			●			●			●			●		●	220			
	UMK 107 △ 271□Z				●	●			●			●			●			●		●	270			
	UMK 107 △ 331□Z				●	●			●			●			●			●		●	330			
UMK 107 △ 391□Z				●	●			●			●			●			●		●	390				
UMK 107 △ 471□Z				●	●			●			●			●			●		●	470				
UMK 107 △ 561□Z				●	●			●			●			●			●		●	560				
UMK 107 △ 681□Z				●	●			●			●			●			●		●	680				
UMK 107 △ 821□Z				●	●			●			●			●			●		●	820				
UMK 107 △ 102□Z				●	●			●			●			●			●		●	1000				

注：形名の△には温度特性、□には静電容量許容差記号が入ります。
 △ Please specify the temperature characteristics code and □ the capacitance tolerance code.

一般積層セラミックコンデンサ

(高誘電率系・Class 2)

STANDARD MULTILAYER CERAMIC CAPACITORS (CLASS2 :HIGH DIELECTRIC CONSTANT TYPE)

	code	Temp.characteristics	operating Temp. range
OPERATING TEMP.	B/BJ	B	-25~+85°C
		X7R	-55~+125°C
		X5R	-55~+85°C
	F	F	-25~+85°C
		Y5V	-30~+85°C

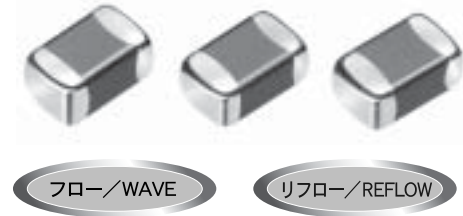

特長 FEATURES

- ・実装密度の向上が図れます
- ・モノリシックの構造のため、信頼性が高い
- ・同一形状、静電容量範囲が広い

- ・ Improve Higher Mounting Densities.
- ・ Multilayer block structure provides higher reliability
- ・ A wide range of capacitance values available in standard case sizes.

用途 APPLICATIONS

- ・一般電子機器用
- ・通信機器用（携帯電話、PHS、コードレス電話 etc.）

- ・ General electronic equipment
- ・ Communication equipment (portable telephones, PHS, other wireless applications, etc.)

形名表記法 ORDERING CODE

1 定格電圧 (VDC)	4 形状寸法(EIA)L×W(mm)	6 公称静電容量 (pF)	7 容量許容差 (%)	9 個別仕様
A 4 J 6.3 L 10 E 16 T 25 U 50	063(0201) 0.6×0.3 105(0402) 1.0×0.5 107(0603) 1.6×0.8	例 102 1000 223 22000	K ±10 M ±20 Z ±20	- 標準
2 シリーズ名	5 温度特性		8 製品厚み (mm)	10 包装
M 積層コンデンサ	△B, BJ ±10% △F ±20%		P 0.3 V 0.5 Z 0.8	B 単品(袋詰め) F テーピング(2mmピッチ・178φ) T テーピング(4mmピッチ・178φ)
3 端子電極	△=スペース			11 当社管理記号
K メッキ品				△ 標準 △=スペース

L	M	K	1	0	5	B	J	1	0	4	K	V	-	F	○
1	2	3	4	5	6	7	8	9	10	11					

1 Rated voltage(VDC)	4 Dimensions (case size)(L×W)(mm)	6 Nominal Capacitance(pF)	7 Capacitance Tolerance(%)	9 Special code
A 4 J 6.3 L 10 E 16 T 25 U 50	063(0201) 0.6×0.3 105(0402) 1.0×0.5 107(0603) 1.6×0.8	example 102 1000 223 22000	K ±10 M ±20 Z ±20	- Standard products
2 Series name	5 Temperature characteristics code		8 Thickness(mm)	10 Packaging
M Multilayer ceramic capacitors	△B X7R -55~+125°C ±15% BJ X5R -55~+85°C ±15% △F Y5V -30~+85°C ±22%		P 0.3 V 0.5 Z 0.8	B Bulk F Tape&Reel(2mm pitch・178φ) T Tape&Reel(4mm pitch・178φ)
3 End termination	△=Blank space			11 Internal code
K Plated				△ Standard Products △=Blank space

外形寸法 EXTERNAL DIMENSIONS

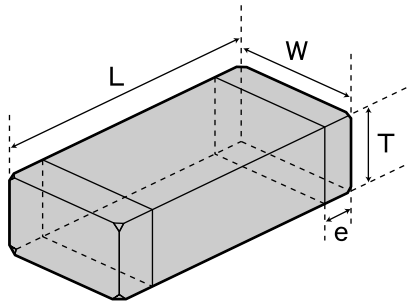

Type(EIA)	L	W	T	e
□MK063 (0201)	0.6±0.03 (0.024±0.001)	0.3±0.03 (0.012±0.001)	0.3±0.03 (0.012±0.001)	P 0.15±0.05 (0.006±0.002)
□MK105 (0402)	1.0±0.05 (0.039±0.002)	0.5±0.05 (0.020±0.002)	0.5±0.05 (0.020±0.002)	V 0.25±0.10 (0.010±0.002)
□MK107 (0603)	1.6±0.10 (0.063±0.004)	0.8±0.10 (0.031±0.004)	0.8±0.10 (0.031±0.004)	Z 0.35±0.25 (0.014±0.010)

Unit : mm(inch)

概略バリエーション AVAILABLE CAPACITANCE RANGE

■汎用積層セラミックコンデンサ (General Multilayer Ceramic capacitors)

Type	063				105						107							
Temp.char.	BJ/X5R		F/Y5V		BJ/X7R			F/Y5V			B/X7R		F/Y5V					
Cap [pF]	16V	10V	6.3V	4V	50V	25V	16V	10V	6.3V	50V	25V	16V	10V	6.3V	50V	25V	50V	25V
100																		
150																		
220																		
330																		
470																		
680																		
1000																		
1500																		
2200																		
3300																		
4700																		
6800																		
10000																		
15000																		
22000																		
33000																		
47000																		
68000																		
100000																		
220000																		
470000																		
1000000																		

注：グラフの記号は製品厚み記号です。 Note: Letter codes in shaded areas are thickness codes. *1 Items are only available in X5R

温度特性 Temperature Characteristics

温度特性 Temperature Characteristics	温度範囲 Operating temp. range [°C]	基準温度 Ref. Temp. [°C]	静電容量 変化率 Capacitance Change [%]
B	-25~85	20	±10
X7R	-55~125	25	±15
X5R	-55~85	25	±15
F	-25~85	20	+30 -80
Y5V	-30~85	25	+22 -82

静電容量許容差 Capacitance Tolerance

記号 Code	許容差 Tolerance	区分 Item
K	±10%	B Char.
M	±20%	B Char.
Z	+80% -20%	F Char.

tan δ

Type	tan δ ※1	区分 Item
063	≤3.5%	B Char. 16V
	≤5.0%	B Char. 10V
	≤16%	F Char. 6.3V
	≤20%	F Char. 4V
105	≤2.5%	B Char. 50V, 25V (0.0068μF)
	≤3.5%	B Char. 16V, 0.027~0.047μF, 25V (0.01μF)
	≤5.0%	F Char. 50V, 25V B Char. 0.056~0.22μF
	≤7.0%	F Char. 0.033μF, 0.047μF
	≤9.0%	F Char. 0.068μF~0.1μF
	≤11%	F Char. 0.22μF
	≤16%	F Char. 0.47μF
107	≤20%	F Char. 1μF
	≤2.5%	B Char.
	≤5.0%	F Char.

※1 測定周波数 Measurement frequency=1±0.1kHz
測定電圧 Measurement voltage =1±0.2Vrms

セレクションガイド
Selection Guide

アイテム一覧
Part Numbers

特性図
Electrical Characteristics

梱包
Packaging

信頼性
Reliability Data

使用上の注意
Precautions



etc

063TYPE(0201 case size)

定格電圧 Rated Voltage (DC)	形名 Ordering code	公称静電容量 Capacitance [pF]	温度特性 Temp.Char	tan δ Dissipation factor [%]Max.	実装条件 Soldering method R: リフロー- Reflow soldering W: フロー- Wave soldering	静電容量許容差 Capacitance tolerance [%]	厚み Thickness (mm)(inch)
16V	EMK063 BJ101□P	100	B/X5R	3.5	R	±10% ±20%	0.3±0.03 (0.012±0.001)
	EMK063 BJ151□P	150					
	EMK063 BJ221□P	220					
	EMK063 BJ331□P	330					
	EMK063 BJ471□P	470					
	EMK063 BJ681□P	680					
10V	LМК063 BJ152□P	1500	B/X5R	5	R	±10% ±20%	0.3±0.03 (0.012±0.001)
	LМК063 BJ222□P	2200					
	LМК063 BJ332□P	3300					
	LМК063 BJ472□P	4700					
	LМК063 BJ682□P	6800					
	LМК063 BJ103□P	10000					
6.3V	JMK063 F223ZP	22000	F/Y5V	16	R	+80% -20%	0.3±0.03 (0.012±0.001)
	JMK063 F473ZP	47000					
4V	AMK063 F104ZP	100000		20			

形名の□には静電容量許容差記号が入ります。

□Please specify the capacitance tolerance code.

105TYPE(0402 case size)

定格電圧 Rated Voltage (DC)	形名 Ordering code	公称静電容量 Capacitance [pF]	温度特性 Temp.Char	tan δ Dissipation factor [%]Max.	実装条件 Soldering method R: リフロー- Reflow soldering W: フロー- Wave soldering	静電容量許容差 Capacitance tolerance [%]	厚み Thickness (mm)(inch)		
50V	UMK105 BJ221□V	220	B/X7R	2.5	R	±10% ±20%	0.5±0.05 (0.020±0.002)		
	UMK105 BJ331□V	330							
	UMK105 BJ471□V	470							
	UMK105 BJ681□V	680							
	UMK105 BJ102□V	1000							
	UMK105 BJ152□V	1500							
	UMK105 BJ222□V	2200							
	UMK105 BJ332□V	3300							
25V	TMK105 BJ472□V	4700	B/X7R	3.5	R	±10% ±20%	0.5±0.05 (0.020±0.002)		
	TMK105 BJ682□V	6800							
	TMK105 BJ103□V	10000							
16V	EMK105 BJ153□V	15000	B/X5R	5	R	±10% ±20%	0.5±0.05 (0.020±0.002)		
	EMK105 BJ223□V	22000							
	EMK105 BJ333□V	33000							
	EMK105 BJ473□V	47000							
10V	LМК105 BJ683□V	68000	B/X5R	5	R	±10% ±20%	0.5±0.05 (0.020±0.002)		
	LМК105 BJ104□V	100000							
6.3V	JMK105 BJ224□V	220000							
50V	UMK105 F103ZV	10000	F/Y5V	5	R	+80% -20%	0.5±0.05 (0.020±0.002)		
25V	TMK105 F223ZV	22000							
16V	EMK105 F473ZV	47000						7	
	EMK105 F104ZV	100000							
10V	LМК105 F224ZV	220000						11	
	JMK105 F474ZV	470000							16
	JMK105 F105ZV*	1000000							
6.3V	JMK105 F105ZV*	1000000						20	

形名の□には静電容量許容差記号が入ります。

□Please specify the capacitance tolerance code.

* 高温負荷試験の試験電圧は定格電圧の1.5倍

* Test voltage of Loading at high temperature test is 1.5 time of the rated voltage.

107TYPE(0603 case size)

定格電圧 Rated Voltage (DC)	形名 Ordering code	公称 静電容量 Capacitance [pF]	温度特性 Temp.Char	tan δ Dissipation factor [%]Max.	実装条件 Soldering method R: リフロー Reflow soldering W: フロ Wave soldering	静電容量 許容差 Capacitance tolerance [%]	厚み Thickness (mm)(inch)
50V	UMK107 B102□Z	1000	B/X7R	2.5	W, R	±10% ±20%	0.8±0.10 (0.031±0.004)
	UMK107 B152□Z	1500					
	UMK107 B222□Z	2200					
	UMK107 B332□Z	3300					
	UMK107 B472□Z	4700					
	UMK107 B682□Z	6800					
25V	TMK107 B153□Z	15000	F/Y5V	5	W, R	+80% -20%	0.8±0.10 (0.031±0.004)
	TMK107 B223□Z	22000					
50V	UMK107 F103ZZ	10000	F/Y5V	5	W, R	+80% -20%	0.8±0.10 (0.031±0.004)
	UMK107 F223ZZ	22000					
25V	TMK107 F473ZZ	47000	F/Y5V	5	W, R	+80% -20%	0.8±0.10 (0.031±0.004)
	TMK107 F104ZZ	100000					

形名の□には静電容量許容差記号が入ります。

□Please specify the capacitance tolerance code.

高周波積層セラミックコンデンサ

MULTILAYER CERAMIC CAPACITORS FOR HIGH FREQUENCY APPLICATIONS(1GHz+)

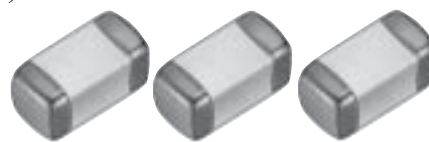

OPERATING TEMP. -55~+125°C

リフロー/REFLOW

特長 FEATURES

- ・積層磁器コンデンサとしては高いQ値が高周波で得られる
- ・1005形状であるため、実装密度の向上、軽量化が図れる
- ・Q values in the high frequency range (1 GHz+) are excellent compared to other types of multilayer capacitors.
- ・The 1005(0402) case size is designed for high density mounting and weight reduction in various applications.

用途 APPLICATIONS

- ・高周波におけるコンデンサのQ値および小型化が求められる用途向き VCO、TCXO etc
- ・高周波回路の特性調整用途
- ・Suitable for those high frequency applications in which a capacitor with both a high Q-value and small size is required such as portable communications and other wireless applications. VCO, TCXO. etc.
- ・Adjustment of characteristics in high frequency circuit

形名表記法 ORDERING CODE

1 定格電圧 (VDC) E 16	4 形状寸法(EIA)L×W(mm) 105(0402) 1.0×0.5	6 公称静電容量 [pF] 例 020 2 4R3 4.3 ※R=小数点	8 製品厚み (mm) W 0.5	10 包装 B 単品(袋づめ) F リールテーピング品(178μmピッチ)
2 シリーズ名 V 高周波用積層コンデンサ	5 温度特性(ppm/°C) CH 0±60 RH -220±60	7 容量許容差 B ±0.1pF J ±5%	9 個別仕様 — 標準	
3 端子電極 K メッキ品				

E V K 1 0 5 R H 4 R 3 J W - F

① ② ③ ④ ⑤ ⑥ ⑦ ⑧ ⑨ ⑩

1 Rated voltage[VDC] E 16	4 Dimensions (case size)(L×W)(mm) 105(0402) 1.0×0.5	6 Nominal Capacitance[pF] example 020 2 4R3 4.3 ※R=Decimal point	8 Thickness(mm) W 0.5	10 Packaging B Bulk F Tape&Reel(2mm pitch・178μ)
2 Series name V MULTILAYER CERAMIC CAPACITORS FOR HIGH FREQUENCY	5 Temperature characteristics(ppm/°C) CH 0±60 RH -220±60	7 Capacitance Tolerances B ±0.1pF J ±5%	9 Special code — Standard Products	
3 End termination K Plated				

外形寸法 EXTERNAL DIMENSIONS

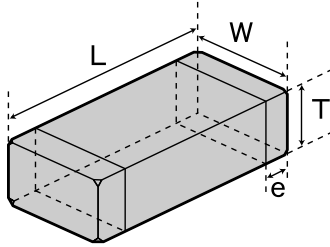

Type(EIA)	L	W	T	e
EVK105 (0402)	1.0±0.05 (0.039±0.002)	0.5±0.05 (0.020±0.002)	0.5±0.05 (0.020±0.002)	0.25±0.1 (0.010±0.004)

Unit : mm(inch)

アイテム一覧 PART NUMBERS

定格電圧 Rated Voltage (DC)	形名 Ordering code	温度特性 Temperature characteristics		公称静電容量 Capacitance [pF]	静電容量許容差 Capacitance tolerance	Q規格値 (at 1GHz) Q (min)	厚み Thickness [mm]	Q typ. 値 (参考値) Typical Q
		CH	RH					
16V	EVK105CH0R3BW	●		0.3	±0.1pF	300	0.5±0.05	1200
	EVK105CH0R4BW	●		0.4		300		1200
	EVK105CH0R5BW	●		0.5		300		1200
	EVK105CH0R6BW	●		0.6		300		1100
	EVK105CH0R7BW	●		0.7		300		1100
	EVK105CH0R8BW	●		0.8		300		1000
	EVK105CH0R9BW	●		0.9		300		950
	EVK105CH010BW	●		1.0		300		950
	EVK105CH1R1BW	●		1.1		280		930
	EVK105CH1R2BW	●		1.2		270		850
	EVK105CH1R3BW	●		1.3		260		740
	EVK105CH1R5BW	●		1.5		240		710
	EVK105CH1R6BW	●		1.6		230		670
	EVK105CH1R8BW	●		1.8		210		650
	EVK105CH020BW	●		2.0		190		610
	EVK105CH2R2JW	●		2.2		180		530
	EVK105CH2R4JW	●		2.4		170		510
	EVK105CH2R7JW	●		2.7		150		460
	EVK105CH030JW	●		3.0	130	390		
	EVK105CH3R3JW	●		3.3	120	370		
	EVK105CH3R6JW	●		3.6	110	360		
	EVK105CH3R9JW	●		3.9	99	360		
	EVK105CH4R3JW	●		4.3	84	360		
	EVK105CH4R7JW	●		4.7	84	340		
	EVK105CH5R1JW	●		5.1	84	320		
	EVK105RH0R5BW		●	0.5	300	1100		
	EVK105RH0R6BW		●	0.6	300	1000		
	EVK105RH0R7BW		●	0.7	300	1000		
	EVK105RH0R8BW		●	0.8	300	970		
	EVK105RH0R9BW		●	0.9	300	950		
	EVK105RH010BW		●	1.0	300	900		
	EVK105RH1R1BW		●	1.1	280	900		
	EVK105RH1R2BW		●	1.2	270	740		
	EVK105RH1R3BW		●	1.3	260	700		
	EVK105RH1R5BW		●	1.5	240	680		
	EVK105RH1R6BW		●	1.6	230	640		
	EVK105RH1R8BW		●	1.8	210	620		
	EVK105RH020BW		●	2.0	190	570		
	EVK105RH2R2JW		●	2.2	180	480		
	EVK105RH2R4JW		●	2.4	170	470		
	EVK105RH2R7JW		●	2.7	150	420		
	EVK105RH030JW		●	3.0	130	360		
	EVK105RH3R3JW		●	3.3	120	350		
	EVK105RH3R6JW		●	3.6	110	340		
	EVK105RH3R9JW		●	3.9	99	340		
	EVK105RH4R3JW		●	4.3	84	340		
	EVK105RH4R7JW		●	4.7	84	320		
	EVK105RH5R1JW		●	5.1	84	310		

仕様 SPECIFICATIONS

温度特性 Temperature Characteristics	使用温度範囲 Operating Temperature range	温度係数範囲 Temperature Coefficient range [ppm/°C]	静電容量許容差 Capacitance Tolerance (区分)
CH	-55~+125°C	0±60	±0.1pF(~2.0pF)
RH		-220±60	±5% (2.2pF~)

■容量値とQの関係例(CH特性例) Capacitance vs Q value (Typical for CH T.C.)

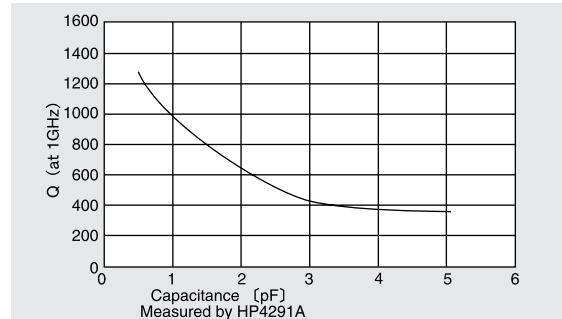

セレクションガイド
Selection Guide

アイテム一覧
Part Numbers

特性図
Electrical Characteristics

梱包
Packaging

信頼性
Reliability Data

使用上の注意
Precautions



etc

超低歪積層セラミックコンデンサ (CFCAP)

SUPER LOW DISTORTION MULTILAYER CERAMIC CAPACITORS (CFCAP)

OPERATING TEMP. -55~+125°C



リフロー/REFLOW

特長 FEATURES

- ・新規開発を行った誘電体材料を使用し優れた温度特性と内部電極にNiを用いることで、小型・高容量・低コストを実現しました
- ・低歪み率、低ショックノイズでアナログ回路や携帯機器のデジタル回路に最適です
- ・耐熱性、耐破壊電圧、機械的強度が高くフィルムコンデンサの置き換えに最適です

- ・ Newly developed dielectric material and the use of nickel for internal electrodes provide excellent temperature characteristics with high capacitance, small case size and low cost.
- ・ Low distortion and low shock noise make these capacitors well suited for use in analog or digital mobile devices.
- ・ Excellent heat-resistance, high break down voltage, and mechanical strength make these capacitors well suited for replacing film capacitors.

用途 APPLICATIONS

- ・ AV関連機器などの信号回路
- ・ アナログ信号のカップリング用途
- ・ 携帯電話のPLL回路
- ・ 良好な温度特性による時定数回路、発信回路、フィルタなど

- ・ Signal line for AV products
- ・ Analog signal coupling applications
- ・ PLL circuit of mobile phones
- ・ Good temperature characteristics for time constant circuits, oscillation circuits and filters

形名表記法 ORDERING CODE

1 定格電圧 (VDC)	3 端子電極	5 シリーズ記号	7 容量許容差	9 個別仕様
U 50 G 35 T 25 E 16 L 10	K メッキ品	SD スタンダード	K ±10 %	- 標準
2 シリーズ名	4 形状寸法 (EIA)L×W(mm)	6 公称静電容量 (pF)	8 製品厚み (mm)	10 包装
M 積層コンデンサ	107(0603) 1.6×0.8 212(0805) 2.0×1.25 316(1206) 3.2×1.6	例 223 22,000 104 100,000	A 0.8 D 0.85 F 1.15 G 1.25 L 1.6	B 単品 (袋づめ) T リールテーピング
				11 当社管理記号
				○ 標準品 ○=スペース

T M K 3 1 6 S D 1 0 4 K L - T ○

1 2 3 4 5 6 7 8 9 10 11

1 Rated voltage (VDC)	3 End termination	5 Series Symbol	7 Capacitance tolerances (%)	9 Special code
U 50 G 35 T 25 E 16 L 10	K Plated	SD Standard	K ±10	- Standard products
2 Multilayer ceramic capacitors	4 Dimensions (case size) (mm)	6 Nominal capacitance (pF)	8 Thickness (mm)	10 Packaging
M	107(0603) 1.6×0.8 212(0805) 2.0×1.25 316(1206) 3.2×1.6	example 223 22,000 104 100,000	A 0.8 D 0.85 F 1.15 G 1.25 L 1.6	B Bulk T Tape & reel
				11 Internal code
				○ Standard products ○=Blank space

外形寸法 EXTERNAL DIMENSIONS

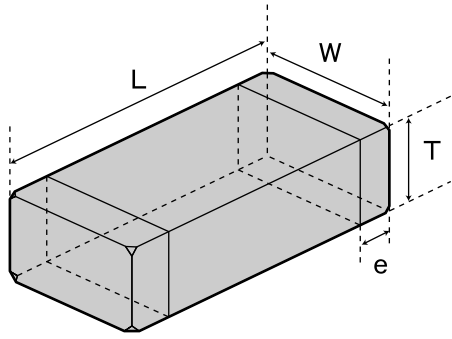

Type(EIA)	L	W	T		e
TMK107 (0603)	1.6±0.10 (0.063±0.004)	0.8±0.10 (0.031±0.004)	0.8±0.10 (0.031±0.004)	A	0.35±0.25 (0.014±0.010)
TMK212 (0805)	2.0±0.10 (0.079±0.004)	1.25±0.10 (0.049±0.004)	0.85±0.10 (0.033±0.004)	D	0.5±0.25 (0.020±0.010)
			1.25±0.10 (0.049±0.004)	G	
TMK316 (1206)	3.2±0.15 (0.126±0.006)	1.6±0.15 (0.063±0.006)	1.15±0.10 (0.045±0.004)	F	0.5 ^{+0.35} _{-0.25} (0.020 ^{+0.014} _{-0.010})
			1.6±0.20 (0.063±0.008)	L	

Unit : mm (inch)

概略バリエーション AVAILABLE CAPACITANCE RANGE

Cap [nF]	Type	107				212				316	
	Temp.Char	SD				SD				SD	SD
	VDC [pF:3digits]	50V	25V	16V	10V	50V	35V	16V	10V	35V	25V
1	102	A									
1.5	152	A									
2.2	222	A									
3.3	332	A									
4.7	472		A			D					
6.8	682			A		D					
10	103			A		D					
15	153				A		D				
22	223				A		G				
33	333							D		F	
47	473								D		F
68	683								G		F
100	104								G		L

※グラフ記号は製品厚みを表します。 Letters inside the shaded boxes indicate thickness.

シリーズコード Series Code	静電容量許容差[%] Capacitance tolerance	tanδ[%] Dissipation factor
SD	±10(K)	0.1%max.

セレクションガイド
Selection Guide



アイテム一覧
Part Numbers



特性図
Electrical Characteristics



梱包
Packaging



信頼性
Reliability Data



使用上の注意
Precautions



アイテム一覧 PART NUMBERS

■107TYPE (0603 case size)

定格電圧	形名	公称静電容量	温度特性	tan δ	実装条件	静電容量許容差	厚み
RatedVoltage	Ordering code	Capacitance [nF]	Temperature characteristics Standard type	Dissipation factor [%]Max.	Soldering method R:リフロー Reflow soldering W:フロー Wave soldering	Capacitance tolerance	Thickness [mm](inch)
50V	UMK107SD102KA	1.0	Standard type	0.1	R	±10%*	0.8±0.1 (0.031±0.004)
	UMK107SD122KA	1.2					
	UMK107SD152KA	1.5					
	UMK107SD182KA	1.8					
	UMK107SD222KA	2.2					
	UMK107SD272KA	2.7					
25V	UMK107SD332KA	3.3					
16V	TMK107SD472KA	4.7					
	EMK107SD682KA	6.8					
10V	EMK107SD103KA	10					
	LMK107SD153KA	15					
	LMK107SD223KA	22					

*: J交差(±5%)も対応致します。御相談ください。

■212TYPE (0805 case size)

定格電圧	形名	公称静電容量	温度特性	tan δ	実装条件	静電容量許容差	厚み
RatedVoltage	Ordering code	Capacitance [nF]	Temperature characteristics Standard type	Dissipation factor [%]Max.	Soldering method R:リフロー Reflow soldering W:フロー Wave soldering	Capacitance tolerance	Thickness [mm](inch)
50V	UMK212SD392KD	3.9	Standard type	0.1	R	±10%*	0.85±0.1 (0.033±0.004)
	UMK212SD472KD	4.7					
	UMK212SD562KD	5.6					
	UMK212SD682KD	6.8					
	UMK212SD822KD	8.2					
	UMK212SD103KD	10					
35V	GMK212SD123KD	12					
	GMK212SD153KD	15					
	GMK212SD183KG	18					
	GMK212SD223KG	22					
	GMK212SD273KG	27					
16V	EMK212SD333KD	33					
10V	LMK212SD473KD	47					
	LMK212SD683KG	68					
	LMK212SD104KG	100					

*: J交差(±5%)も対応致します。御相談ください。

■316TYPE (1206 case size)

定格電圧	形名	公称静電容量	温度特性	tan δ	実装条件	静電容量許容差	厚み			
RatedVoltage	Ordering code	Capacitance [nF]	Temperature characteristics Standard type	Dissipation factor [%]Max.	Soldering method R:リフロー Reflow soldering W:フロー Wave soldering	Capacitance tolerance	Thickness [mm](inch)			
35V	GMK316SD333KF	33	Standard type	0.1	R	±10%*	1.15±0.1 (0.045±0.004)			
	GMK316SD393KF	39								
25V	TMK316SD473KF	47								
	TMK316SD563KF	56								
	TMK316SD683KF	68								
	TMK316SD823KL	82								
	TMK316SD104KL	100								1.6±0.2 (0.063±0.008)

*: J交差(±5%)も対応致します。御相談ください。

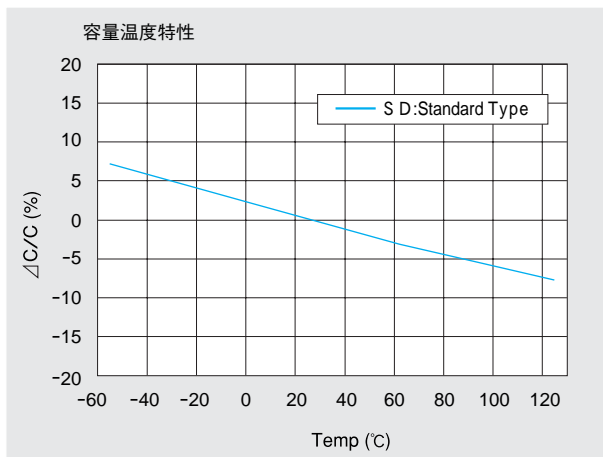

Super Low Distortion Multilayer Ceramic Capacitors (CFCAP)

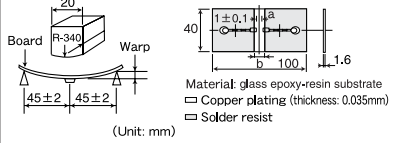
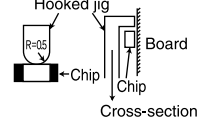
Item	Specified Value	Test Methods and Remarks
1. Operating Temperature Range	-55 to +125°C	
2. Storage Temperature Range	-55 to +125°C	
3. Rated Voltage	10VDC, 16VDC, 25VDC, 35VDC, 50VDC,	
4. Withstanding Voltage Between terminals	No breakdown or damage	Applied voltage: Rated voltage×3 Duration: 1 to 5 sec. Charge/discharge current: 50mA max.
5. Insulation Resistance	10000 MΩ or 500MΩ μF, whichever is smaller	Applied voltage: Rated voltage Duration: 60±5 sec. Charge/discharge current: 50mA max.
6. Capacitance (Tolerance)	±10%	Measuring frequency : 1 k Hz±10% Measuring voltage : 1±0.2Vrms Bias application: None
7. Tangent of Loss Angle (tan δ)	0.1%max	Measuring frequency : 1 k Hz±10% Measuring voltage : 1±0.2Vrms Bias application: None
8. Resistance to Flexure of Substrate	Appearance: No abnormality Capacitance change: ±5%	Warp: 1mm Speed: 0.5mm/second Duration: 10 seconds The measurement shall be made with the board in the bent position.  (Unit: mm)
9. Body strength		
10. Adhesion of electrode	No separation or indication of separation of electrode.	Applied force: 5N Duration: 30 ±5 seconds 
11. Solderability	At least 95% of terminal electrode is covered by new solder.	Solder temp.: 230 ±5°C Duration: 4 ±1 seconds
12. Resistance to soldering	Appearance: No abnormality Capacitance change: ±2.5% max. tanδ: Initial value Insulation resistance: Initial value Withstanding voltage (between terminals): No abnormality	Solder temp.: 270 ±5°C Duration: 3 ±0.5 seconds Preheating conditions: 80 to 100°C, 2 to 5 min. or 5 to 10 min. 150 to 200°C, 2 to 5 min. or 5 to 10 min. Recovery: Recovery for the following period under the standard condition after the test: 24 ±2hrs
13. Thermal shock	Appearance: No abnormality Capacitance change: ±2.5% max tanδ: Initial value Insulation resistance: Initial value Withstanding voltage (between terminals): No abnormality	Conditions for 1 cycle: Step 1: Minimum operating temperature +0/-3 °C 30±3 minutes Step 2: Room temperature 2 to 3min. Step 3: Maximum operating temperature -0/+3 °C 30±3 minutes Step 4: Room temperature 2 to 3min. Number of cycles: 5 times Recovery after the test: 24±2hrs
14. Damp heat (steady state)	Appearance: No abnormality Capacitance change: ±5% max tanδ: 0.5% max Insulation resistance 50MΩ μF or 1000MΩ whichever is smaller	Temperature: 40±2°C Humidity: 90 to 95% RH Duration: 500 +24/-0 hrs Recovery: Recovery for the following period under the standard condition after the removal from test chamber: 24 ±2hrs

Super Low Distortion Multilayer Ceramic Capacitors (CFCAP)

Item	Specified Value	Test Methods and Remarks
15.Loading under Damp Heat	Appearance: No abnormality Capacitance change: $\pm 7.5\%$ max $\tan\delta$: 0.5% max Insulation resistance: 25M Ω μ F or 500M Ω whichever is smaller	According to JIS C 5102 clause 9.9. Temperature:40 \pm 2 $^{\circ}$ C Humidity:90 to 95% RH Duration:500 $^{+24}_{-0}$ hrs Applied voltage: Rated voltage Charge/discharge current:50mA max Recovery: Recovery for the following period under the standard condition after the removal from test chamber: 24 \pm 2hrs
16.Loading at High Temperature	Appearance: No abnormality Capacitance change: $\pm 3\%$ max $\tan\delta$: 0.35% max Insulation resistance: 50M Ω μ F or 1000M Ω whichever is smaller	According to JIS C 5102 clause 9.9. Temperature:125 \pm 3 $^{\circ}$ C Duration:1000 $^{+48}_{-0}$ hrs Applied voltage: Rated voltage x 2 Recovery: Recovery for the following period under the standard condition after the removal from test chamber: 24 \pm 2hrs

Note on standard condition: "standard condition" referred to herein is defined as follows.

Temperature: 5 to 35 $^{\circ}$ C, Relative humidity: 45 to 85 %, Air pressure: 86 to 106kpa,

When there are questions concerning measurement results: In order to provide correlation data, the test shall be conducted under condition.

Temperature: 20 \pm 2 $^{\circ}$ C, Relative humidity: 65 to 70 %, Air pressure: 86 to 106kpa

Unless otherwise specified,all the tests are conducted under the "standard condition."

中高耐圧積層セラミックコンデンサ

MEDIUM-HIGH VOLTAGE MULTILAYER CERAMIC CAPACITOR

	code	Temp.characteristics	operating Temp. range
OPERATING TEMP.	BJ	B	- 25~+85°C
		X5R	- 55~+85°C
		X7R	- 55~+125°C

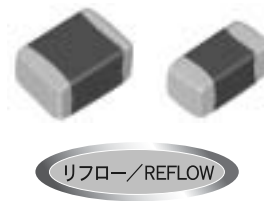

特長 FEATURES

- ・内部電極にNi金属を使用しており、マイグレーションが発生せず、高信頼性を示す。
- ・高定格電圧でありながら小型形状
- ・The use of Nickel(Ni) as material for internal electrodes almost completely eliminates migration and high reliability
- ・Small case sizes with high rated voltage

用途 APPLICATIONS

- ・一般電話交換機
- ・インバータ
- ・無線、通信基地局
- ・General telephone exchange
- ・Inverter.
- ・Wireless and Telecommunication base.

形名表記法 ORDERING CODE

1 定格電圧 (VDC)	H 100 Q 250 S 630	3 端子電極	K メッキ品	5 温度特性 (%)	B J ±10	7 容量許容差	K ±10% M ±20%	9 個別仕様	- 標準
2 シリーズ名	M 積層コンデンサ	4 形状寸法 (EIA)L×W(mm)	212(0805) 2.0×1.25 316(1206) 3.2×1.6 325(1210) 3.2×2.5 432(1812) 4.5×3.2	6 公称静電容量 (pF)	例 104 100,000 105 1,000,000	8 製品厚み (mm)	G 1.25 F 1.15 L 1.6 N 1.9 M 2.5	10 包装	B 単品 (袋詰め) T リールテーピング
								11 当社管理記号	△ 標準品 △=スペース

H	M	K	3	1	6	B	J	1	0	4	K	L	-	T	○
1	2	3	4	5	6	7	8	9	10	11					

1 Rated voltage(VDC)	H 100 Q 250 S 630	3 End termination	K Plated	5 Temperature characteristics code	B J X7R -55~+125°C±15% B J X5R -55~+85°C±15%	7 Capacitance tolerances(%)	K ±10 M ±20	9 Special code	- Standard products
2 Series name	M Multilayer ceramic capacitors	4 Dimensions(case size)(mm)	212(0805) 2.0×1.25 316(1206) 3.2×1.6 325(1210) 3.2×2.5 432(1812) 4.5×3.2	6 Nominal capacitance(pF)	example 104 100,000 105 1,000,000	8 Thickness(mm)	G 1.25 F 1.15 L 1.6 N 1.9 M 2.5	10 Packaging	B Bulk T Tape & reel
								11 Internal code	△ Standard products △=Blank space

外形寸法 EXTERNAL DIMENSIONS

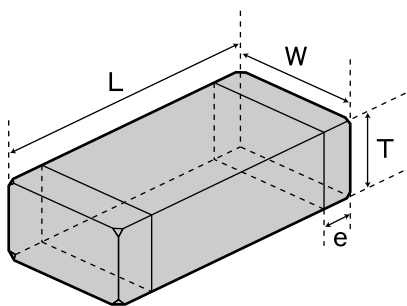

Type(EIA)	L	W	T		e
□MK212 (0805)	2.0±0.10 (0.079±0.004)	1.25±0.10 (0.049±0.004)	1.25±0.10 (0.033±0.004)	G	0.3以上 (0.012min.)
□MK316 (1206)	3.2±0.15 (0.126±0.006)	1.6±0.15 (0.063±0.006)	1.15±0.10 (0.045±0.004)	F	0.3以上 (0.012min.)
			1.6±0.20 (0.063±0.008)	L	
□MK325 (1210)	3.2±0.15 (0.126±0.006)	2.5±0.20 (0.098±0.006)	1.15±0.10 (0.045±0.004)	F	0.3以上 (0.012min.)
			1.9±0.20 (0.075±0.008)	N	
□MK432 (1812)	4.5±0.4 (0.177±0.016)	3.2±0.30 (0.126±0.012)	2.5±0.20 (0.098±0.008)	M	0.3以上 (0.012min.)

Unit : mm (inch)

概略バリエーション AVAILABLE CAPACITANCE RANGE

Cap [μF]	Type	212			316					325					432				
	Temp.Char VDC [pF:3digits]	B/X7R 100V	B/X7R 250V	B/X5R 250V	B/X7R 100V	B/X7R 250V	B/X5R 250V	B/X7R 630V	B/X5R 630V	B/X7R 100V	B/X7R 250V	B/X5R 250V	B/X7R 630V	B/X5R 630V	B/X7R 100V	B/X7R 250V	B/X5R 250V	B/X7R 630V	B/X5R 630V
0.01	103	G	G					F											
0.022	223	G		G				L					N						
0.047	473	G			L	L						N		N					M
0.1	104				L		L		F	N						M			M
0.22	224				L				N		N					M			
0.47	474								N						M		M		
1.0	105													M					

※グラフ記号は製品厚みを表します。 Letters inside the shaded boxes indicate thickness.

温度特性コード Temp. char.Code	温度特性 Temperature characteristics					静電容量許容差(%) Capacitance tolerance	tanδ(%) Dissipation factor
	準拠規格 Applicable standard		温度範囲(°C) Temperature range	基準温度(°C) Ref. Temp.	静電容量変化率(%) Capacitance change		
	JIS	B	-25~85	20	±10		
BJ	EIA	X7R	-55~125	25	±15	±20(M) ±10(K)	3.5%
		X5R	-55~85	25	±15		

セレクションガイド
Selection Guide



etc

アイテム一覧
Part Numbers



特性図
Electrical Characteristics



梱包
Packaging



信頼性
Reliability Data



使用上の注意
Precautions



アイテム一覧 PART NUMBERS

■212TYPE(0805 case size)

定格電圧 RatedVoltage	形名 Ordering code	公称静電容量 Capacitance [μ F]	温度特性 Temperature characteristics	$\tan \delta$ Dissipation factor [%]Max.	実装条件 Soldering method R:リフロー Rework soldering W:ワロ Wave soldering	静電容量許容差 Capacitance tolerance	厚み Thickness [mm] (inch)
100V	HMK212BJ103□G	0.01	B/X7R	3.5	R	±10%, ±20%	1.25±0.1 (0.033±0.004)
	HMK212BJ223□G	0.022					
	HMK212BJ473□G	0.047					
250V	QMK212BJ103□G	0.01	B/X7R	3.5	R	±10%, ±20%	1.25±0.1 (0.033±0.004)
	QMK212BJ223□G	0.022	B/X5R				

■316TYPE(1206 case size)

定格電圧 RatedVoltage	形名 Ordering code	公称静電容量 Capacitance [μ F]	温度特性 Temperature characteristics	$\tan \delta$ Dissipation factor [%]Max.	実装条件 Soldering method R:リフロー Rework soldering W:ワロ Wave soldering	静電容量許容差 Capacitance tolerance	厚み Thickness [mm] (inch)
100V	HMK316BJ473□L	0.047	B/X7R	3.5	R	±10%, ±20%	1.6±0.2 (0.063±0.008)
	HMK316BJ104□L	0.1					
	HMK316BJ224□L	0.22					
250V	QMK316BJ473□L	0.047	B/X5R	3.5	R	±10%, ±20%	1.6±0.2 (0.063±0.008)
	QMK316BJ104□L	0.1	B/X7R				
630V	SMK316BJ103□F	0.01	B/X7R	3.5	R	±10%, ±20%	1.15±0.1 (0.045±0.004)
	SMK316BJ223□L	0.022	B/X5R				1.6±0.2 (0.063±0.008)

■325TYPE(1210 case size)

定格電圧 RatedVoltage	形名 Ordering code	公称静電容量 Capacitance [μ F]	温度特性 Temperature characteristics	$\tan \delta$ Dissipation factor [%]Max.	実装条件 Soldering method R:リフロー Rework soldering W:ワロ Wave soldering	静電容量許容差 Capacitance tolerance	厚み Thickness [mm] (inch)
100V	HMK325BJ104□F	0.10	B/X7R	3.5	R	±10%, ±20%	1.15±0.1 (0.045±0.004)
	HMK325BJ224□N	0.22					
	HMK325BJ474□N	0.47					
250V	QMK325BJ473□N	0.47	B/X5R	3.5	R	±10%, ±20%	1.9±0.2 (0.075±0.008)
	QMK325BJ104□N	0.10					
	QMK325BJ224□N	0.22					
630V	SMK325BJ223□N	0.022	B/X7R	3.5	R	±10%, ±20%	1.9±0.2 (0.075±0.008)
	SMK325BJ473□N	0.047	B/X5R				

■432TYPE(1812 case size)

定格電圧 RatedVoltage	形名 Ordering code	公称静電容量 Capacitance [μ F]	温度特性 Temperature characteristics	$\tan \delta$ Dissipation factor [%]Max.	実装条件 Soldering method R:リフロー Rework soldering W:ワロ Wave soldering	静電容量許容差 Capacitance tolerance	厚み Thickness [mm] (inch)
100V	HMK432BJ474□M	0.47	B/X7R	3.5	R	±10%, ±20%	2.5±0.2 (0.098±0.008)
	HMK432BJ105□M	1.0					
250V	QMK432BJ104□M	0.1	B/X5R	3.5	R	±10%, ±20%	2.5±0.2 (0.098±0.008)
	QMK432BJ224□M	0.22					
	QMK432BJ474□M	0.47					
630V	SMK432BJ473□M	0.047	B/X7R	3.5	R	±10%, ±20%	2.5±0.2 (0.098±0.008)
	SMK432BJ104□M	0.1	B/X5R				

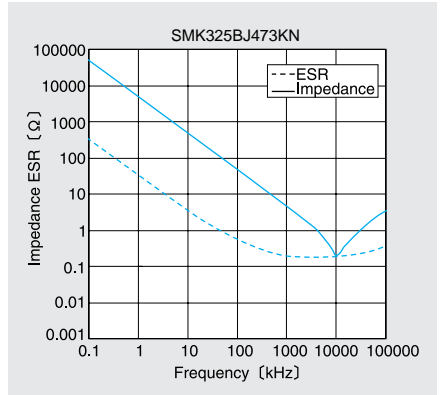
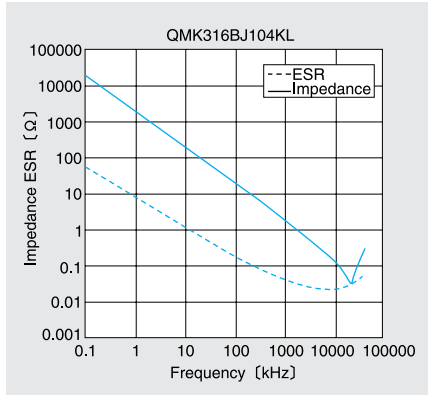
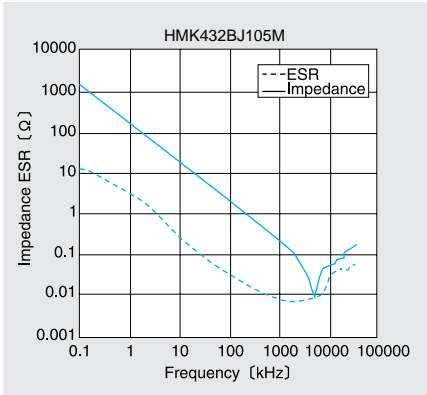

静電容量—温度特性 Temperature characteristics

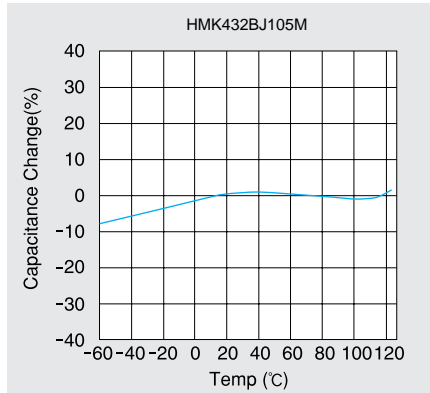

MEDIUM-HIGH VOLTAGE MULTILAYER CERAMIC CAPACITOR

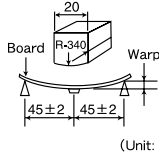
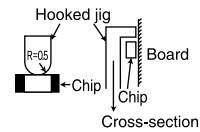
Item	Specified Value	Test Methods and Remarks
1. Operating Temperature Range	X7R : -55 to +125°C X5R: -55 to +85°C B J : -25 to +85°C	
2. Storage Temperature Range	X7R : -55 to +125°C X5R: -55 to +85°C B J : -25 to +85°C	
3. Rated Voltage	100VDC, 250VDC, 630VDC	
4. Withstanding Voltage Between terminals	No breakdown or damage	Applied voltage: Rated voltage $\times 2.5$ (100V) Rated voltage $\times 2$ (250V) Rated voltage $\times 1.2$ (630V) Duration : 1~5sec. Charge/discharge current : 50mAmax.
5. Insulation Resistance	100M Ω μ F or 10GM Ω , whichever is smaller.	Applied voltage: Rated voltage Duration : 60 \pm 5 sec. Charge/discharge current : 50mAmax.
6. Capacitance(Tolerance)	$\pm 20\%$, $\pm 10\%$	Measuring frequency: 1kHz $\pm 10\%$ Measuring voltage: 1 ± 0.2 Vrms Bias application: None
7. Tangent of Loss Angel	3.5%max.	Measuring frequency: 1kHz $\pm 10\%$ Measuring voltage: 1 ± 0.2 Vrms Bias application: None
8. Temperature Characteristic of Capacitance	B J : $\pm 10\%$ (-25 to +85°C) X7R: $\pm 15\%$ (-55 to +125°C) X5R: $\pm 15\%$ (-55 to +85°C)	According to JIS 5102 clause 7.12. Charge of maximum capacitance deviation in step 1 to 5 Temperature at step 1: +25°C Temperature at step 2: minimum operating temperature Temperature at step 3: +25°C (Reference temperature) Temperature at step 4: minimum operating temperature Temperature at step 5: +25°C Reference temperature Characteristic B shall be +20°C
9. Resistance to Flexure of Substrate	Appearance: No abnormality Capacitance change: Within $\pm 10\%$	Warp: 1mm Testing board: glass epoxy-resin substrate Thickness: 1.6mm The measurement shall be made with board in the bent position  (Unit: mm)
10. Adhesion of Electrode	No separation or indication of separation of electrode	Applied force: 5N Duration: 30 \pm 5sec.  Cross-section
11. Solderability	At least 75% of terminal electrode is covered by solder	Solder temperature: 230 \pm 5°C Duration: 4 \pm 1sec.
12. Resistance to Soldering	Appearance: No abnormality Capacitance change: Within $\pm 10\%$ ($\times 5R$, B J), $\pm 15\%$ ($\times 7R$) $\tan \delta$: Initial value Insulation resistance: Initial value Withstanding voltage(between terminals): No abnormality	Preconditioning: Thermal treatment(at 150°C for 1hr) Solder temperature: 270 \pm 5°C Duration: 3 \pm 0.5sec. Preheating conditions: 80 to 100°C, 2 to 5 min. 150 to 200°C, 2 to 5 min. Recovery: Recovery for the following period under the standard condition after the test. 48 \pm 4hrs
13. Thermal shock	Appearance: No abnormality Capacitance change: Within $\pm 10\%$ ($\times 5R$, B J), $\pm 15\%$ ($\times 7R$) $\tan \delta$: Initial value Insulation resistance: Initial value	Preconditioning: Thermal treatment(at 150°C for 1hr) Conditions for 1 cycle Step 1: Minimum operating temperature +0/-3°C 30 \pm 3min. Step 2: Room temperature 2 to 3min. Step 3: Minimum operating temperature +0/-3°C 30 \pm 3min. Step 4: Room temperature 2 to 3min. Number of cycles: 5 times Recovery after the test: 48 \pm 4hrs

アレイ形積層セラミックコンデンサ

ARRAY TYPE MULTILAYER CERAMIC CAPACITOR

	code	Temp.characteristics	operating Temp. range
OPERATING TEMP.	BJ	B	-25~+85°C
		X5R	-55~+85°C
		X7R	-55~+125°C
	CH	C0H	-55~+125°C

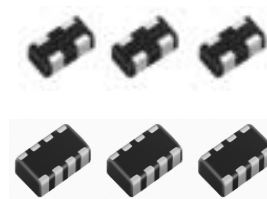

リフロー／REFLOW

特長 FEATURES

- ・2125形状で4回路構成であるため、より高密度、高効率な実装を実現
- ・1回路あたりの容量は1 μ Fの大容量
- ・内部電極には、信頼性とコストパフォーマンスに優れたNiを使用しています。

- ・4 circuits in 2125 package allows higher placement density and efficiency
- ・The capacitance in each circuit, F or B dielectric, is 1 μ F
- ・Internal electrode is nickel for increased cost performance and reliability

用途 APPLICATIONS

- ・一般電子機器用
- ・通信機器用 (携帯電話、PHS、コードレス電話etc)

- ・General electronic equipment
- ・Communication equipment (mobile phone, PHS, cordless phone, etc.)

形名表記法 ORDERING CODE

1 定格電圧 (VDC)	
J	6.3
L	10
E	16
T	25
U	50

2 シリーズ名	
4	4 連積層コンデンサ
2	2 連積層コンデンサ

3 端子電極	
K	メッキ品

4 形状寸法 (EIA)L×W(mm)	
110(0504)	1.4×1.0
212(0805)	2.0×1.25

5 温度特性	
BJ	±10[%]
CH	0±60[ppm/°C]

6 公称静電容量 (pF)	
例	
104	100,000
105	1,000,000

7 容量許容差	
M	±20 %
K	±10 %

8 製品厚み (mm)	
B	0.6
A	0.8
D	0.85

9 個別仕様	
-	標準

10 包装	
T	リールテーピング

11 当社管理記号	
△	標準品
△	スペース



1 Rated voltage (VDC)	
J	6.3
L	10
E	16
T	25
U	50

2 Series name	
4	4 circuit multilayer capacitors
2	2 circuit multilayer capacitors

3 End termination	
K	Plated

4 Dimensions (case size)(mm)	
110(0504)	1.4×1.0
212(0805)	2.0×1.25

5 Temperature characteristics code	
X5R	-55~+85°C±15%
X7R	-55~+125°C±15%
C0H	0±60[ppm/°C]

6 Nominal capacitance (pF)	
example	
104	100,000
105	1,000,000

7 Capacitance tolerances (%)	
M	±20
K	±10

8 Thickness (mm)	
B	0.6
A	0.8
D	0.85

9 Special code	
-	Standard products

10 Packaging	
T	Tape & reel

11 Internal code	
△	Standard products
△	Blank space

外形寸法 EXTERNAL DIMENSIONS

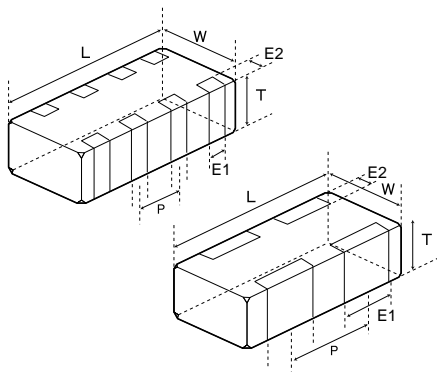

Type(EIA)	L	W	E1	E2	P	T	
□2K110 (0504)	1.37±0.07 (0.054±0.003)	1.00±0.08 (0.039±0.008)	0.36±0.10 (0.014±0.004)	0.20±0.10 (0.008±0.004)	0.64±0.10 (0.025±0.004)	B	0.60±0.06 (0.024±0.003)
						A	0.80±0.08 (0.031±0.003)
□4K212 (0805)	2.00±0.10 (0.079±0.004)	1.25±0.10 (0.049±0.004)	0.25±0.10 (0.010±0.004)	0.25±0.15 (0.010±0.006)	0.50±0.10 (0.020±0.004)	D	0.85±0.10 (0.033±0.004)
□2K212 (0805)	2.00±0.10 (0.079±0.004)	1.25±0.10 (0.049±0.004)	0.50±0.20 (0.020±0.008)	0.25±0.15 (0.010±0.006)	1.00±0.10 (0.039±0.004)	D	0.85±0.10 (0.033±0.004)

Unit : mm (inch)

概略バリエーション AVAILABLE CAPACITANCE RANGE

Cap [μF]	BJ/ X7R, BJ/ X5R								
	Type	1410 2連 □2K110				2125 2連 □2K212		2125 4連 □4K212	
	Temp.Char	BJ/ X7R		BJ/ X5R		BJ/ X5R		BJ/ X5R	
	VDC	25V	16V	10V	6.3V	10V	6.3V	16V	10V
0.01	103	B							
0.022	223	B							
0.047	473		B						
0.1	104		B					D	
0.22	224			B					D
0.47	474			A					
1.0	105				A	D			
2.2	225						D		

※ グラフ記号は製品厚みを表します。 Letters inside the shaded boxes indicate thickness.

Cap [pF]	CH/ C0H	
	Type	1410 2連 □2K110
	Temp.Char	CH / C0G
	VDC	50V
10	100	B
12	120	B
15	150	B
18	180	B
22	220	B
27	270	B
33	330	B
39	390	B
47	470	B
56	560	B
68	680	B
82	820	B
100	101	B

※ グラフ記号は製品厚みを表します。 Letters inside the shaded boxes indicate thickness.

温度特性コード Temp. char.Code	温度特性 Temperature characteristics				静電容量許容差(%) Capacitance tolerance	tanδ(%) Dissipation factor	
	標準規格 Applicable standard		温度範囲(°C) Temperature range	基準温度(°C) Ref. Temp.			静電容量変化率 Capacitance change
BJ	JIS	B	-25~85	20	±10[%]	±20(M) ±10(K) 5.0%max.*	
	EIA	X5R	-55~85	25	±15[%]		
	EIA	X7R	-55~125	25	±15[%]		
CH	JIS	CH	-55~125	20	±60[ppm/c]	±10(K) 0.1%max.**	
	EIA	C0H	-55~125	25	±60[ppm/c]		

* 10% : J2K 3.5% : 110type C<0.1μF
** 27pF以下 Q≧400+20·C 30pF以上 Q≧1000

セレクションガイド
Selection Guide

アイテム一覧
Part Numbers

特性図
Electrical Characteristics

梱包
Packaging

信頼性
Reliability Data

使用上の注意
Precautions



etc

アイテム一覧 PART NUMBERS

■1410TYPE (0504 case size) 2連タイプ (2 circuit type)

定格電圧 Rated Voltage	形名 Ordering code	公称静電容量 Capacitance [μF]	温度特性 Temperature characteristics	tan δ Dissipation factor[%]Max.	実装条件 Soldering method R:リフロー Reflow soldering W:フロー Wave soldering	静電容量許容差 Capacitance tolerance	厚み Thickness [mm](inch)
25V	T2K110BJ103□B	0.01	B/X7R	3.5	R	±20%[M] ±10%[K]	0.6±0.06 (0.024±0.002)
	T2K110BJ223□B	0.022					
16V	E2K110BJ473□B	0.047		5			
	E2K110BJ104□B	0.1					
10V	L2K110BJ224□B	0.22	B/X5R	10			
	L2K110BJ474MA	0.47					
6.3V	J2K110BJ105MA	1.0					0.8±0.08 (0.031±0.003)

定格電圧 Rated Voltage	形名 Ordering code	公称静電容量 Capacitance [pF]	温度特性 Temperature characteristics	Q symbol	実装条件 Soldering method R:リフロー Reflow soldering W:フロー Wave soldering	静電容量許容差 Capacitance tolerance	厚み Thickness [mm](inch)
50V	U2K110CH100FB	10	CH	400+20・C	R	±10%[K]	0.6±0.06 (0.024±0.002)
	U2K110CH120KB	12					
	U2K110CH150KB	15					
	U2K110CH180KB	18					
	U2K110CH220KB	22					
	U2K110CH270KB	27					
	U2K110CH330KB	33		1000 (0.1%)			
	U2K110CH390KB	39					
	U2K110CH470KB	47					
	U2K110CH560KB	56					
	U2K110CH680KB	68					
	U2K110CH820KB	82					
	U2K110CH101KB	100					

*:J交差(±5%)も対応致します。御相談ください。

■2125TYPE (0805 case size) 4連タイプ (4 circuit type)

定格電圧 Rated Voltage	形名 Ordering code	公称静電容量 Capacitance [μF]	温度特性 Temperature characteristics	tan δ Dissipation factor[%]Max.	実装条件 Soldering method R:リフロー Reflow soldering W:フロー Wave soldering	静電容量許容差 Capacitance tolerance	厚み Thickness [mm](inch)
16V	E4K212BJ104□D	0.1	B/X5R	5	R	±20%[M] ±10%[K]	0.85±0.1 (0.033±0.004)
10V	L4K212BJ224□D	0.22					

■2125TYPE (0805 case size) 2連タイプ (2 circuit type)

定格電圧 Rated Voltage	形名 Ordering code	公称静電容量 Capacitance [μF]	温度特性 Temperature characteristics	tan δ Dissipation factor[%]Max.	実装条件 Soldering method R:リフロー Reflow soldering W:フロー Wave soldering	静電容量許容差 Capacitance tolerance	厚み Thickness [mm](inch)
10V	L2K212BJ105MD	1.0	B/X5R	5	R	±20%[M]	0.85±0.1 (0.033±0.004)
6.3V	J2K212BJ225MD	2.2		10			

インピーダンス・ESR-周波数特性例 Example of Impedance ESR vs. Frequency characteristics

・当社積層セラミックコンデンサ例 (Taiyo Yuden multilayer ceramic capacitor)

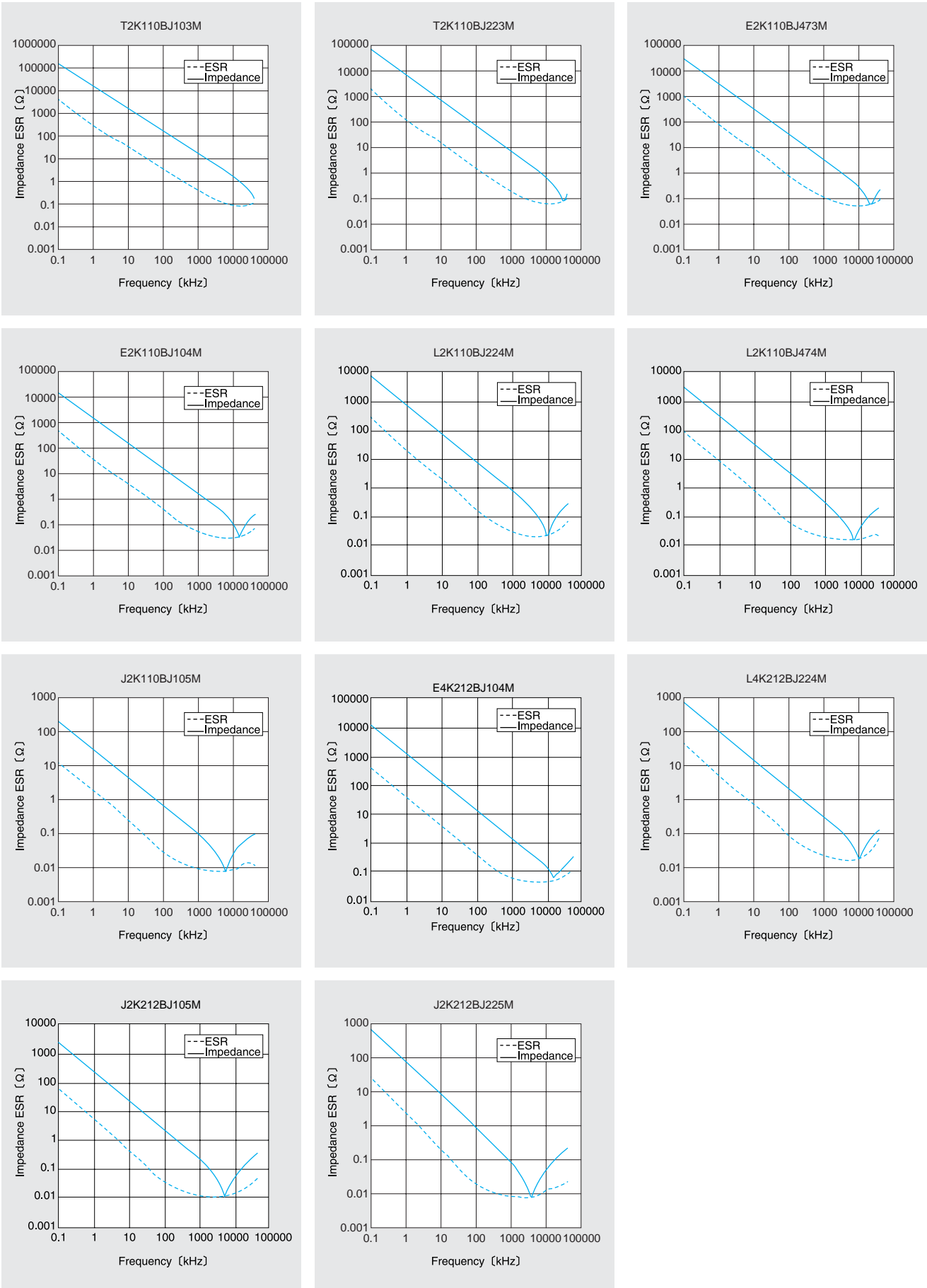

梱包 PACKAGING

①標準数量 Standard quantity

■袋づめ梱包 Bulk packaging

形式(EIA) Type	製品厚み Thickness		標準数量 Standard quantity [pcs]
	mm(inch)	code	
□MK105(0402)	0.5 (0.020)	V, W	1000
E VK105(0402)		W	
□MK107(0603)	0.8 (0.031)	A	
		Z	
□2K110(0504)	0.8 (0.031)	A	
	0.6 (0.024)	B	
	0.85 (0.033)	D	
□MK212(0805)	1.25 (0.049)	G	
□4K212(0805)	0.85 (0.033)	D	
□2K212(0805)	0.85 (0.033)	D	
	0.85 (0.033)	D	
□MK316(1206)	1.15 (0.045)	F	
	1.25 (0.049)	G	
	1.6 (0.063)	L	
	0.85 (0.033)	D	
□MK325(1210)	1.15 (0.045)	F	
	1.5 (0.059)	H	
	1.9 (0.075)	N	
	2.0max (0.079)	Y	
	2.5 (0.098)	M	

■テーピング梱包 Taped packaging

形式(EIA) Type	製品厚み Thickness		標準数量 Standard quantity [pcs]		
	mm(inch)	code		紙テープ paper	エンボステープ Embossed tape
□MK063(0201)	0.3 (0.012)	P	15000	—	
□MK105(0402)	0.5 (0.020)	V, W	10000	—	
E VK105(0402)		W			
□MK107(0603)	0.45 (0.018)	K	4000	—	
	0.8 (0.031)	A	4000	—	
		Z			
□2K110(0504)	0.8 (0.031)	A	4000	—	
	0.6 (0.024)	B	4000	—	
	0.45 (0.018)	K	4000	—	
□MK212(0805)	0.85 (0.033)	D	4000	—	
	1.25 (0.049)	G	—	3000	
□4K212(0805)	0.85 (0.033)	D	4000	—	
□2K212(0805)	0.85 (0.033)	D	4000	—	
	0.85 (0.033)	D	4000	—	
□MK316(1206)	1.15 (0.045)	F	—	3000	
	1.25 (0.049)	G	—		
	1.6 (0.063)	L	—	2000	
	0.85 (0.033)	D	—		
□MK325(1210)	1.15 (0.045)	F	—	2000	
	1.5 (0.059)	H	—		
	1.9 (0.075)	N	—		
	2.0max (0.079)	Y	—	2000	
	2.5 (0.098)	M	—	500	
□MK432(1812)	1.9(0.075)	Y	—		
	2.5(0.098)	M	—	500	
	3.2(0.125)	U	—		

②テーピング材質 Taping material

紙テープ
Card board carrier tape

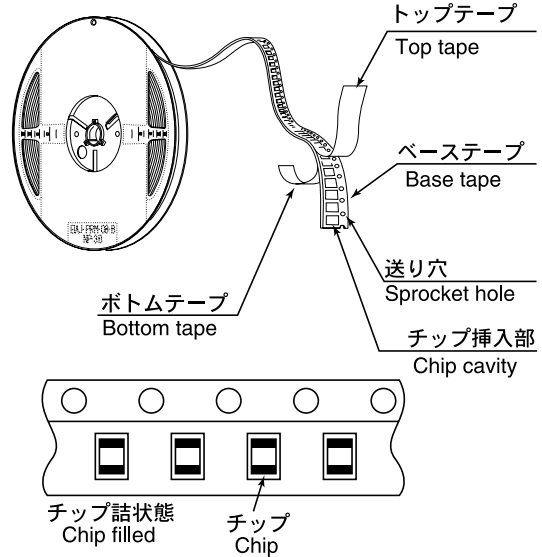

エンボステープ
Embossed Tape

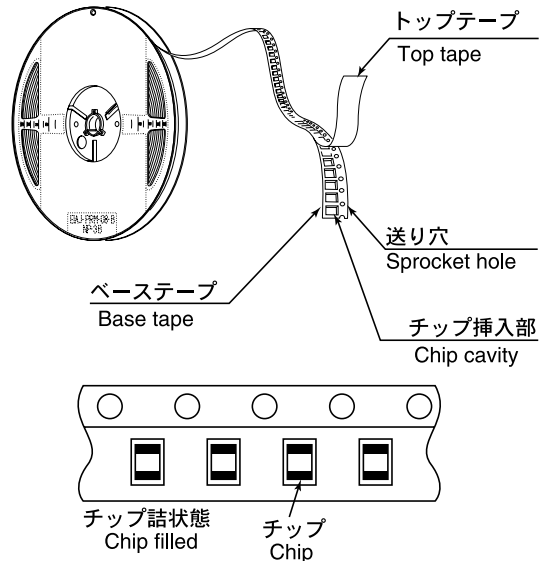

③バルクカセット Bulk Cassette

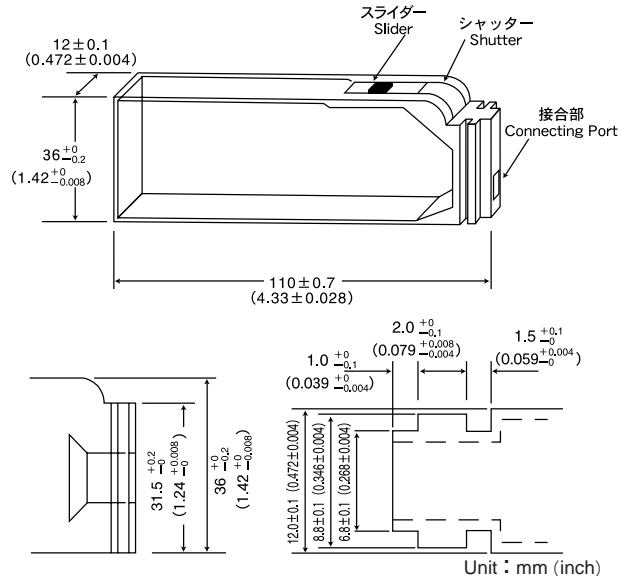

105, 107, 212形状で個別対応致しますのでお問い合わせ下さい。
Please contact any of our offices for accepting your requirement according to dimensions 0402, 0603, 0805.(inch)

③テーピング寸法 Taping dimensions

紙テープ Paper Tape (8mm幅) (0.315inches wide)

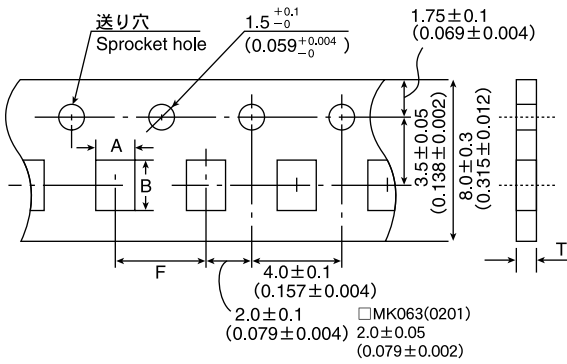

Type (EIA)	チップ挿入部 Chip Cavity		挿入ピッチ Insertion Pitch F	テープ厚み Tape Thickness	
	A	B		K	T
□MK063(0201)	0.37±0.06 (0.06±0.002)	0.67±0.06 (0.027±0.002)	2.0±0.05 (0.079±0.002)	0.45max. (0.018max.)	
□MK105(0402) E VK105(0402)	0.65±0.1 (0.026±0.004)	1.15±0.1 (0.045±0.004)	2.0±0.05 (0.079±0.002)	0.8max. (0.031max.)	
□MK107(0603)	1.0±0.2 (0.039±0.008)	1.8±0.2 (0.071±0.008)	4.0±0.1 (0.157±0.004)	1.1max. (0.043max.)	
□2K110(0504)	1.15±0.2 (0.045±0.008)	1.55±0.2 (0.061±0.008)	4.0±0.1 (0.157±0.004)	1.0max. (0.039max.)	
□MK212(0805)	1.65±0.2 (0.065±0.008)	2.4±0.2 (0.094±0.008)	4.0±0.1 (0.157±0.004)	1.1max. (0.043max.)	
□4K212(0805)					
□2K212(0805)					
□MK316(1206)	2.0±0.2 (0.079±0.008)	3.6±0.2 (0.142±0.008)			

Unit : mm(inch)

エンボステープ Embossed tape (8mm幅) (0.315inches wide)

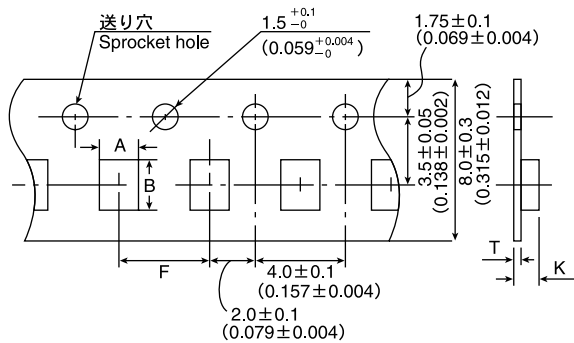

Type (EIA)	チップ挿入部 Chip cavity		挿入ピッチ Insertion Pitch F	テープ厚み Tape Thickness	
	A	B		K	T
□MK212(0805)	1.65±0.2 (0.065±0.008)	2.4±0.2 (0.094±0.008)	4.0±0.1 (0.157±0.004)		
□MK316(1206)	2.0±0.2 (0.079±0.008)	3.6±0.2 (0.142±0.008)		2.5max. (0.098max.)	0.6max. (0.024max.)
□MK325(1210)	2.8±0.2 (0.110±0.008)	3.6±0.2 (0.142±0.008)		3.4max. (0.134max.)	

Unit : mm(inch)

エンボステープ Embossed tape (12mm幅) (0.472inches wide)

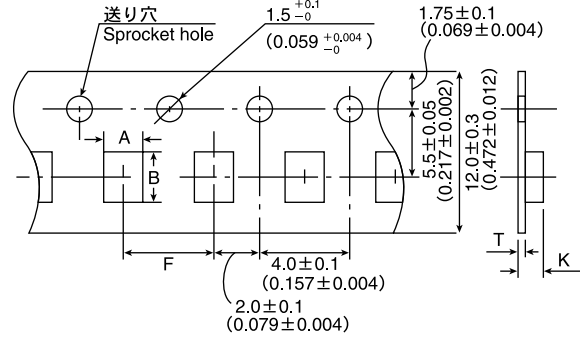

Type (EIA)	チップ挿入部 Chip cavity		挿入ピッチ Insertion Pitch F	テープ厚み Tape Thickness	
	A	B		K	T
□MK432(1812)	3.7±0.2 (0.146±0.008)	4.9±0.2 (0.193±0.008)	8.0±0.1 (0.315±0.004)	3.4max. (0.134max.)	0.6max. (0.024max.)

Unit : mm(inch)

④リーダー部/空部 Leader and Blank portion

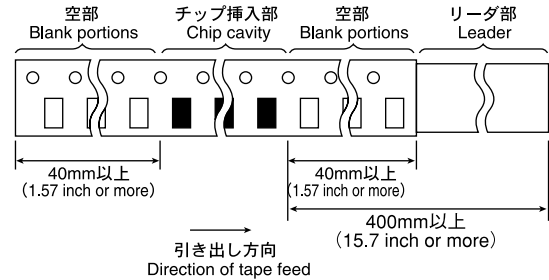

⑤リール寸法 Reel size

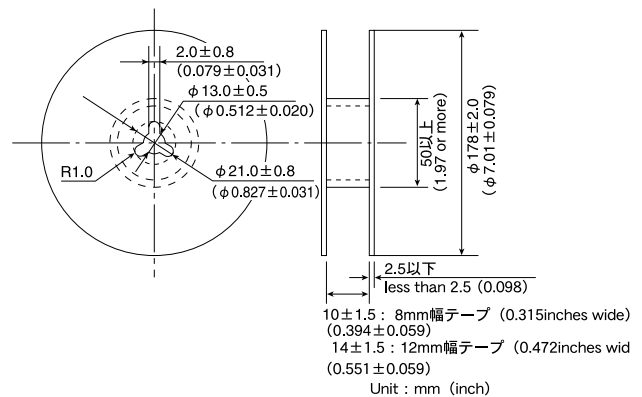

⑥トップテープ強度 Top Tape Strength

トップテープのはがし力は下図矢印方向にて0.1~0.7Nとなります。
The top tape requires a peel-off force of 0.1~0.7N in the direction of the arrow as illustrated below.

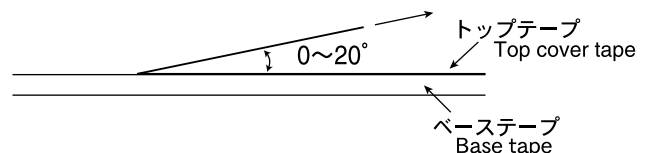

Multilayer Ceramic Capacitor Chips

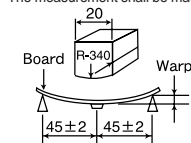
Item	Specified Value				Test Methods and Remarks
	Temperature Compensating (Class 1)		High Permittivity (Class 2)		
	Standard	High Frequency Type	Standard Note1	High Value	
1. Operating Temperature Range	-55 to +125°C		B : -55 to +125°C F : -25 to +85°C	-25 to +85°C	High Capacitance Type BJ(X7R) : -55~+125°C, BJ(X5R) : -55~+85°C C(X5S) : -55~+85°C, C(X6S) : -55~+105°C E(Y5U) : -30~+85°C, F(Y5V) : -30~+85°C
2. Storage Temperature Range	-55 to +125°C		B : -55 to +125°C F : -25 to +85°C	-25 to +85°C	High Capacitance Type BJ(X7R) : -55~+125°C, BJ(X5R) : -55~+85°C C(X5S) : -55~+85°C, C(X6S) : -55~+105°C E(Y5U) : -30~+85°C, F(Y5V) : -30~+85°C
3. Rated Voltage	50VDC, 25VDC, 16VDC	16VDC	50VDC, 25VDC	50VDC, 35VDC, 25VDC 16VDC, 10VDC, 6.3VDC 4DVC	
4. Withstanding Voltage Between terminals	No breakdown or damage	No abnormality	No breakdown or damage		Applied voltage: Rated voltage×3 (Class 1) Rated voltage×2.5 (Class 2) Duration: 1 to 5 sec. Charge/discharge current: 50mA max. (Class 1,2)
5. Insulation Resistance	10000 MΩ min.		500 MΩ μF. or 10000 MΩ., whichever is the smaller. Note 4		Applied voltage: Rated voltage Duration: 60±5 sec. Charge/discharge current: 50mA max.
6. Capacitance (Tolerance)	0.5 to 5 pF: ±0.25 pF 1 to 10pF: ±0.5 pF 5 to 10 pF: ±1 pF 11 pF or over: ± 5% ±10% 105TYPERΔ, SΔ, TΔ, UΔ only 0.5~2pF: ±0.1pF 2.2~20pF: ±5%	0.5 to 2 pF : ±0.1 pF 2.2 to 5.1 pF : ±5%	B: ±10%, ±20% F: $\begin{matrix} +80 \\ -20 \end{matrix}$ %	BJ : ±10%、±20% C : ±10%、±20% E : -20%/+80% F : -20%/+80%	Measuring frequency : Class 1 : 1MHz±10%(C≤1000pF) 1 k Hz±10%(C>1000pF) Class 2 : 1 k Hz±10%(C≤22μF) 120Hz±10Hz(C>22μF) Measuring voltage : Class 1 : 0.5~5Vrms(C≤1000pF) 1±0.2Vrms(C>1000pF) Class 2 : 1±0.2Vrms(C≤22μF) 0.5±0.1Vrms(C>22μF) Bias application: None
7. Q or Tangent of Loss Angle (tan δ)	Under 30 pF : Q≥400 + 20C 30 pF or over : Q≥1000 C= Nominal capacitance	Refer to detailed specification	B: 2.5% max. (50V, 25V) F: 5.0% max. (50V, 25V)	BJ : 2.5%以下 3.5%以下※ 5.0%以下※ 10.0%以下※ C、E、F : 7%以下 5.0%以下※ 9.0%以下※ 10.0%以下※ 11.0%以下※ 16.0%以下※ 20.0%以下※ See Table 1	Multilayer: Measuring frequency : Class 1 : 1MHz±10%(C≤1000pF) 1 k Hz±10%(C>1000pF) Class 2 : 1 k Hz±10%(C≤22μF) 120Hz±10Hz(C>22μF) Measuring voltage : Class 1 : 0.5~5Vrms(C≤1000pF) 1±0.2Vrms(C>1000pF) Class 2 : 1±0.2Vrms(C≤22μF) 0.5±0.1Vrms(C>22μF) Bias application: None High-Frequency-Multilayer: Measuring frequency: 1GHz Measuring equipment: HP4291A Measuring jig: HP16192A
8. Temperature Characteristic of Capacitance	(Without voltage application) CK : 0±250 CJ : 0±120 CH : 0±60 CG : 0±30 PK : -150±250 PJ : -150±120 PH : -150±60 RK : -220±250 RJ : -220±120 RH : -220±60 SK : -330±250 SJ : -330±120 SH : -330±60 TK : -470±250 TJ : -470±120 TH : -470±60 UK : -750±250 UJ : -750±120 SL : +350 to -1000 (ppm/°C)	CH : 0±60 RH : -220±60 (ppm/°C)	B : ±10%(-25~85°C) F : $\begin{matrix} +30 \\ -80 \end{matrix}$ %(-25~85°C) B(X7R) : ±15% F(Y5V) : $\begin{matrix} +22 \\ -82 \end{matrix}$ %	BJ : ±10% (-25~+85°C) C : ±20% (-25~+85°C) E : +20%/ -55% (-25~+85°C) F : +30%/ -80% (-25~+85°C) BJ(X7R、X5R) : ±15% C(X5S、X6S) : ±22% E(Y5U) : +22%/ -56% F(Y5V) : +22%/ -82%	According to JIS C 5102 clause 7.12. Temperature compensating: Measurement of capacitance at 20°C and 85°C shall be made to calculate temperature characteristic by the following equation. $\frac{(C_{85} - C_{20})}{C_{20}} \times 10^6 \times \Delta T$ (ppm/°C) High permittivity: Change of maximum capacitance deviation in step 1 to 5 Temperature at step 1: +20°C Temperature at step 2: minimum operating temperature Temperature at step 3: +20°C (Reference temperature) Temperature at step 4: maximum operating temperature Temperature at step 5: +20°C Reference temperature for X7R, X5R, X5S, X6S, Y5U and Y5V shall be +25°C
9. Resistance to Flexure of Substrate	Appearance: No abnormality Capacitance change: Within ±5% or ±0.5 pF, whichever is larger.	Appearance: No abnormality Capacitance change: Within ±0.5 pF	Appearance: No abnormality Capacitance change: B, BJ, C: Within ±12.5% E, F: Within ±30%	Warp: 1mm Testing board: glass epoxy-resin substrate Thickness: 1.6mm (063 TYPE : 0.8mm) The measurement shall be made with board in the bent position.  (Unit: mm)	



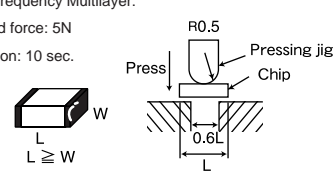
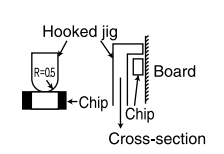

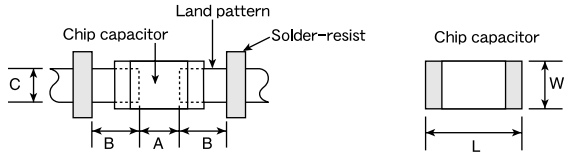
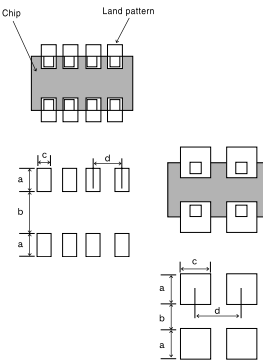

Multilayer Ceramic Capacitor Chips

Item	Specified Value				Test Methods and Remarks
	Temperature Compensating (Class 1)		High Permittivity (Class 2)		
	Standard	High Frequency Type	Standard Note1	High Value	
10.Body Strength	—	No mechanical damage.	—	—	High Frequency Multilayer: Applied force: 5N Duration: 10 sec. 
11.Adhesion of Electrode	No separation or indication of separation of electrode.				Applied force: 5N Duration: 30±5 sec. 
12.Solderability	At least 95% of terminal electrode is covered by new solder.				Solder temperature: 230±5°C Duration: 4±1 sec.
13.Resistance to soldering	Appearance: No abnormality Capacitance change: Within ± 2.5% or ±0.25pF, whichever is larger. Q: Initial value Insulation resistance: Initial value Withstanding voltage (between terminals): No abnormality	Appearance: No abnormality Capacitance change: Within ±2.5% Q: Initial value Insulation resistance: Initial value Withstanding voltage (between terminals): No abnormality	Appearance: No abnormality Capacitance change: Within ±7.5% (B, BJ) Within ±15% (C) Within ±20% (E, F) tan δ: Initial value Insulation resistance: Initial value Withstanding voltage (between terminals): No abnormality	Preconditioning: Thermal treatment (at 150°C for 1 hr) (Applicable to Class 2.) Solder temperature: 270±5°C Duration: 3±0.5 sec. Preheating conditions: 80 to 100°C, 2 to 5 min. or 5 to 10 min. 150 to 200°C, 2 to 5 min. or 5 to 10 min. Recovery: Recovery for the following period under the standard condition after the test. 24±2 hrs (Class 1) 48±4 hrs (Class 2)	
14.Thermal shock	Appearance: No abnormality Capacitance change: Within ± 2.5% or ±0.25pF, whichever is larger. Q: Initial value Insulation resistance: Initial value Withstanding voltage (between terminals): No abnormality	Appearance: No abnormality Capacitance change: Within ±0.25pF Q: Initial value Insulation resistance: Initial value Withstanding voltage (between terminals): No abnormality	Appearance: No abnormality Capacitance change: Within ±7.5% (B, BJ) Within ±15% (C) Within ±20% (E, F) tan δ: Initial value Insulation resistance: Initial value Withstanding voltage (between terminals): No abnormality	Preconditioning: Thermal treatment (at 150°C for 1 hr) (Applicable to Class 2.) Conditions for 1 cycle: Step 1: Minimum operating temperature -3°C 30±3 min. Step 2: Room temperature 2 to 3 min. Step 3: Maximum operating temperature $+3^{\circ}\text{C}$ 30±3 min. Step 4: Room temperature 2 to 3 min. Number of cycles: 5 times Recovery after the test: 24±2 hrs (Class 1) 48±4 hrs (Class 2)	
15.Damp Heat (steady state)	Appearance: No abnormality Capacitance change: Within ±5% or ±0.5pF, whichever is larger. Q: $C \geq 30 \text{ pF} : Q \geq 350$ $10 \leq C < 30 \text{ pF} : Q \geq 275 + 2.5C$ $C < 10 \text{ pF} : Q \geq 200 + 10C$ C: Nominal capacitance Insulation resistance: 1000 MΩ min.	Appearance: No abnormality Capacitance change: Within ±0.5pF, Insulation resistance: 1000 MΩ min.	Appearance: No abnormality Capacitance change: B: Within ±12.5% F: Within ±30% tan δ: B: 5.0% max. F: 7.5% max. Insulation resistance: 50 MΩ μ F or 1000 MΩ whichever is smaller.	Appearance: No abnormality Capacitance change: BJ: Within ±12.5% Within ±30%※※ C(X6S) Within ±25% C(X5S),E,F Within ±30% tan δ: BJ: 5.0% max. 7.5% max.※ 20.0% max.※ C, E, F: 11.0% max. 7.5% max.※ 15.0% max.※ 16.0% max.※ 19.5% max.※ 25.0% max.※ ※ See Table.2 ※※ See Table.5 Insulation resistance: 50 MΩ μ F or 1000 MΩ whichever is smaller.	Multilayer : Preconditioning: Thermal treatment (at 150°C for 1 hr) (Applicable to Class 2.) Temperature: 40±2°C Humidity: 90 to 95% RH Duration: 500 $^{+24}_{-0}$ hrs Recovery: Recovery for the following period under the standard condition after the removal from test chamber. 24±2 hrs (Class 1) 48±4 hrs (Class 2) High-Frequency Multilayer: Temperature: 60±2°C Humidity: 90 to 95% RH Duration: 500 $^{+24}_{-0}$ hrs Recovery: Recovery for the following period under the standard condition after the removal from test chamber. 24±2 hrs (Class 1)

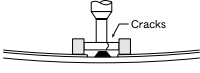
Precautions on the use of Multilayer Ceramic Capacitors

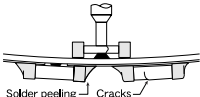
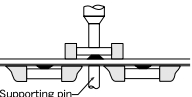
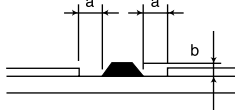
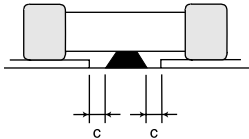
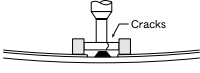
Stages	Precautions	Technical considerations																																																																																																																																		
1.Circuit Design	<p>Verification of operating environment, electrical rating and performance</p> <p>1. A malfunction in medical equipment, spacecraft, nuclear reactors, etc. may cause serious harm to human life or have severe social ramifications. As such, any capacitors to be used in such equipment may require higher safety and/or reliability considerations and should be clearly differentiated from components used in general purpose applications.</p> <p>Operating Voltage (Verification of Rated voltage)</p> <p>1. The operating voltage for capacitors must always be lower than their rated values.</p> <p>If an AC voltage is loaded on a DC voltage, the sum of the two peak voltages should be lower than the rated value of the capacitor chosen. For a circuit where both an AC and a pulse voltage may be present, the sum of their peak voltages should also be lower than the capacitor's rated voltage.</p> <p>2. Even if the applied voltage is lower than the rated value, the reliability of capacitors might be reduced if either a high frequency AC voltage or a pulse voltage having rapid rise time is present in the circuit.</p>																																																																																																																																			
2.PCB Design	<p>Pattern configurations (Design of Land-patterns)</p> <p>1. When capacitors are mounted on a PCB, the amount of solder used (size of fillet) can directly affect capacitor performance. Therefore, the following items must be carefully considered in the design of solder land patterns:</p> <p>(1) The amount of solder applied can affect the ability of chips to withstand mechanical stresses which may lead to breaking or cracking. Therefore, when designing land-patterns it is necessary to consider the appropriate size and configuration of the solder pads which in turn determines the amount of solder necessary to form the fillets.</p> <p>(2) When more than one part is jointly soldered onto the same land or pad, the pad must be designed so that each component's soldering point is separated by solder-resist.</p>	<p>1.The following diagrams and tables show some examples of recommended patterns to prevent excessive solder amounts.(larger fillets which extend above the component end terminations)</p> <p>Examples of improper pattern designs are also shown.</p> <p>(1) Recommended land dimensions for a typical chip capacitor land patterns for PCBs</p>  <p>Recommended land dimensions for wave-soldering (unit: mm)</p> <table border="1" data-bbox="853 1255 1236 1430"> <thead> <tr> <th>Type</th> <th>107</th> <th>212</th> <th>316</th> <th>325</th> </tr> </thead> <tbody> <tr> <td rowspan="2">Size</td> <td>L</td> <td>1.6</td> <td>2.0</td> <td>3.2</td> <td>3.2</td> </tr> <tr> <td>W</td> <td>0.8</td> <td>1.25</td> <td>1.6</td> <td>2.5</td> </tr> <tr> <td>A</td> <td>0.8~1.0</td> <td>1.0~1.4</td> <td>1.8~2.5</td> <td>1.8~2.5</td> </tr> <tr> <td>B</td> <td>0.5~0.8</td> <td>0.8~1.5</td> <td>0.8~1.7</td> <td>0.8~1.7</td> </tr> <tr> <td>C</td> <td>0.6~0.8</td> <td>0.9~1.2</td> <td>1.2~1.6</td> <td>1.8~2.5</td> </tr> </tbody> </table> <p>Recommended land dimensions for reflow-soldering (unit: mm)</p> <table border="1" data-bbox="845 1496 1452 1681"> <thead> <tr> <th>Type</th> <th>063</th> <th>105</th> <th>107</th> <th>212</th> <th>316</th> <th>325</th> <th>432</th> <th>550</th> </tr> </thead> <tbody> <tr> <td rowspan="2">Size</td> <td>L</td> <td>0.6</td> <td>1.0</td> <td>1.6</td> <td>2.0</td> <td>3.2</td> <td>3.2</td> <td>4.5</td> <td>5.7</td> </tr> <tr> <td>W</td> <td>0.3</td> <td>0.5</td> <td>0.8</td> <td>1.25</td> <td>1.6</td> <td>2.5</td> <td>3.2</td> <td>5.0</td> </tr> <tr> <td>A</td> <td>0.20~0.30</td> <td>0.45~0.55</td> <td>0.6~0.8</td> <td>0.8~1.2</td> <td>1.8~2.5</td> <td>1.8~2.5</td> <td>2.5~3.5</td> <td>3.7~4.7</td> </tr> <tr> <td>B</td> <td>0.20~0.30</td> <td>0.40~0.50</td> <td>0.6~0.8</td> <td>0.8~1.2</td> <td>1.0~1.5</td> <td>1.0~1.5</td> <td>1.5~1.8</td> <td>1.5~2.3</td> </tr> <tr> <td>C</td> <td>0.25~0.40</td> <td>0.45~0.55</td> <td>0.6~0.8</td> <td>0.9~1.6</td> <td>1.2~2.0</td> <td>1.8~3.2</td> <td>2.3~3.5</td> <td>3.5~5.5</td> </tr> </tbody> </table> <p>Excess solder can affect the ability of chips to withstand mechanical stresses. Therefore, please take proper precautions when designing land-patterns.</p> <table border="1" data-bbox="853 1747 1189 1921"> <thead> <tr> <th>Type</th> <th>316 (4 circuits)</th> <th>212 (4 circuits)</th> </tr> </thead> <tbody> <tr> <td rowspan="2">Size</td> <td>L</td> <td>3.2</td> <td>2.0</td> </tr> <tr> <td>W</td> <td>1.6</td> <td>1.25</td> </tr> <tr> <td>a</td> <td>0.7~0.9</td> <td>0.5~0.6</td> </tr> <tr> <td>b</td> <td>1</td> <td>0.5~0.6</td> </tr> <tr> <td>c</td> <td>0.4~0.5</td> <td>0.2~0.3</td> </tr> <tr> <td>d</td> <td>0.8</td> <td>0.5</td> </tr> </tbody> </table> <table border="1" data-bbox="853 1932 1189 2096"> <thead> <tr> <th>Type</th> <th>212 (2 circuits)</th> <th>110 (2 circuits)</th> </tr> </thead> <tbody> <tr> <td rowspan="2">Size</td> <td>L</td> <td>2.0</td> <td>1.37</td> </tr> <tr> <td>W</td> <td>1.25</td> <td>1.0</td> </tr> <tr> <td>a</td> <td>0.5~0.6</td> <td>0.35~0.45</td> </tr> <tr> <td>b</td> <td>0.5~0.6</td> <td>0.55~0.65</td> </tr> <tr> <td>c</td> <td>0.5~0.6</td> <td>0.3~0.4</td> </tr> <tr> <td>d</td> <td>1.0</td> <td>0.64</td> </tr> </tbody> </table> 	Type	107	212	316	325	Size	L	1.6	2.0	3.2	3.2	W	0.8	1.25	1.6	2.5	A	0.8~1.0	1.0~1.4	1.8~2.5	1.8~2.5	B	0.5~0.8	0.8~1.5	0.8~1.7	0.8~1.7	C	0.6~0.8	0.9~1.2	1.2~1.6	1.8~2.5	Type	063	105	107	212	316	325	432	550	Size	L	0.6	1.0	1.6	2.0	3.2	3.2	4.5	5.7	W	0.3	0.5	0.8	1.25	1.6	2.5	3.2	5.0	A	0.20~0.30	0.45~0.55	0.6~0.8	0.8~1.2	1.8~2.5	1.8~2.5	2.5~3.5	3.7~4.7	B	0.20~0.30	0.40~0.50	0.6~0.8	0.8~1.2	1.0~1.5	1.0~1.5	1.5~1.8	1.5~2.3	C	0.25~0.40	0.45~0.55	0.6~0.8	0.9~1.6	1.2~2.0	1.8~3.2	2.3~3.5	3.5~5.5	Type	316 (4 circuits)	212 (4 circuits)	Size	L	3.2	2.0	W	1.6	1.25	a	0.7~0.9	0.5~0.6	b	1	0.5~0.6	c	0.4~0.5	0.2~0.3	d	0.8	0.5	Type	212 (2 circuits)	110 (2 circuits)	Size	L	2.0	1.37	W	1.25	1.0	a	0.5~0.6	0.35~0.45	b	0.5~0.6	0.55~0.65	c	0.5~0.6	0.3~0.4	d	1.0	0.64
Type	107	212	316	325																																																																																																																																
Size	L	1.6	2.0	3.2	3.2																																																																																																																															
	W	0.8	1.25	1.6	2.5																																																																																																																															
A	0.8~1.0	1.0~1.4	1.8~2.5	1.8~2.5																																																																																																																																
B	0.5~0.8	0.8~1.5	0.8~1.7	0.8~1.7																																																																																																																																
C	0.6~0.8	0.9~1.2	1.2~1.6	1.8~2.5																																																																																																																																
Type	063	105	107	212	316	325	432	550																																																																																																																												
Size	L	0.6	1.0	1.6	2.0	3.2	3.2	4.5	5.7																																																																																																																											
	W	0.3	0.5	0.8	1.25	1.6	2.5	3.2	5.0																																																																																																																											
A	0.20~0.30	0.45~0.55	0.6~0.8	0.8~1.2	1.8~2.5	1.8~2.5	2.5~3.5	3.7~4.7																																																																																																																												
B	0.20~0.30	0.40~0.50	0.6~0.8	0.8~1.2	1.0~1.5	1.0~1.5	1.5~1.8	1.5~2.3																																																																																																																												
C	0.25~0.40	0.45~0.55	0.6~0.8	0.9~1.6	1.2~2.0	1.8~3.2	2.3~3.5	3.5~5.5																																																																																																																												
Type	316 (4 circuits)	212 (4 circuits)																																																																																																																																		
Size	L	3.2	2.0																																																																																																																																	
	W	1.6	1.25																																																																																																																																	
a	0.7~0.9	0.5~0.6																																																																																																																																		
b	1	0.5~0.6																																																																																																																																		
c	0.4~0.5	0.2~0.3																																																																																																																																		
d	0.8	0.5																																																																																																																																		
Type	212 (2 circuits)	110 (2 circuits)																																																																																																																																		
Size	L	2.0	1.37																																																																																																																																	
	W	1.25	1.0																																																																																																																																	
a	0.5~0.6	0.35~0.45																																																																																																																																		
b	0.5~0.6	0.55~0.65																																																																																																																																		
c	0.5~0.6	0.3~0.4																																																																																																																																		
d	1.0	0.64																																																																																																																																		

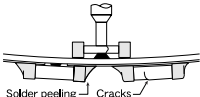
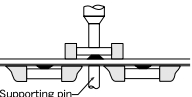
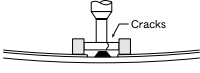
Precautions on the use of Multilayer Ceramic Capacitors

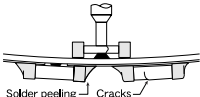
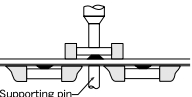
Stages	Precautions	Technical considerations																	
<p>3. Considerations for automatic placement</p>	<p>Adjustment of mounting machine</p> <ol style="list-style-type: none"> Excessive impact load should not be imposed on the capacitors when mounting onto the PC boards. The maintenance and inspection of the mounters should be conducted periodically. <p>Selection of Adhesives</p> <ol style="list-style-type: none"> Mounting capacitors with adhesives in preliminary assembly, before the soldering stage, may lead to degraded capacitor characteristics unless the following factors are appropriately checked; the size of land patterns, type of adhesive, amount applied, hardening temperature and hardening period. Therefore, it is imperative to consult the manufacturer of the adhesives on proper usage and amounts of adhesive to use. 	<ol style="list-style-type: none"> If the lower limit of the pick-up nozzle is low, too much force may be imposed on the capacitors, causing damage. To avoid this, the following points should be considered before lowering the pick-up nozzle: <ol style="list-style-type: none"> The lower limit of the pick-up nozzle should be adjusted to the surface level of the PC board after correcting for deflection of the board. The pick-up pressure should be adjusted between 1 and 3 N static loads. To reduce the amount of deflection of the board caused by impact of the pick-up nozzle, supporting pins or back-up pins should be used under the PC board. The following diagrams show some typical examples of good pick-up nozzle placement: <table border="1" data-bbox="850 526 1449 797"> <thead> <tr> <th></th> <th>Not recommended</th> <th>Recommended</th> </tr> </thead> <tbody> <tr> <td>Single-sided mounting</td> <td></td> <td></td> </tr> <tr> <td>Double-sided mounting</td> <td></td> <td></td> </tr> </tbody> </table> <ol style="list-style-type: none"> As the alignment pin wears out, adjustment of the nozzle height can cause chipping or cracking of the capacitors because of mechanical impact on the capacitors. To avoid this, the monitoring of the width between the alignment pin in the stopped position, and maintenance, inspection and replacement of the pin should be conducted periodically. <ol style="list-style-type: none"> Some adhesives may cause reduced insulation resistance. The difference between the shrinkage percentage of the adhesive and that of the capacitors may result in stresses on the capacitors and lead to cracking. Moreover, too little or too much adhesive applied to the board may adversely affect component placement, so the following precautions should be noted in the application of adhesives. <ol style="list-style-type: none"> Required adhesive characteristics <ol style="list-style-type: none"> The adhesive should be strong enough to hold parts on the board during the mounting & solder process. The adhesive should have sufficient strength at high temperatures. The adhesive should have good coating and thickness consistency. The adhesive should be used during its prescribed shelf life. The adhesive should harden rapidly The adhesive must not be contaminated. The adhesive should have excellent insulation characteristics. The adhesive should not be toxic and have no emission of toxic gasses. The recommended amount of adhesives is as follows; <table border="1" data-bbox="850 1469 1406 1589"> <thead> <tr> <th>Figure</th> <th>212/316 case sizes as examples</th> </tr> </thead> <tbody> <tr> <td>a</td> <td>0.3mm min</td> </tr> <tr> <td>b</td> <td>100 ~ 120 μm</td> </tr> <tr> <td>c</td> <td>Adhesives should not contact the pad</td> </tr> </tbody> </table> <div style="display: flex; justify-content: space-around; margin-top: 20px;"> <div data-bbox="874 1662 1110 1808"> <p>Amount of adhesive</p>  </div> <div data-bbox="1171 1662 1422 1852"> <p>After capacitors are bonded</p>  </div> </div>		Not recommended	Recommended	Single-sided mounting			Double-sided mounting			Figure	212/316 case sizes as examples	a	0.3mm min	b	100 ~ 120 μm	c	Adhesives should not contact the pad
	Not recommended	Recommended																	
Single-sided mounting																			
Double-sided mounting																			
Figure	212/316 case sizes as examples																		
a	0.3mm min																		
b	100 ~ 120 μm																		
c	Adhesives should not contact the pad																		

Precautions on the use of Multilayer Ceramic Capacitors

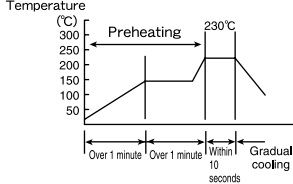
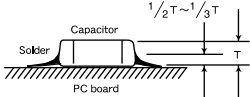
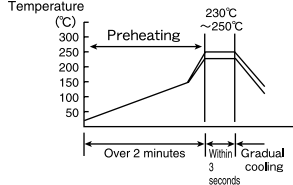
Stages	Precautions	Technical considerations
<p>4. Soldering</p>	<p>Selection of Flux</p> <p>1. Since flux may have a significant effect on the performance of capacitors, it is necessary to verify the following conditions prior to use;</p> <p>(1) Flux used should be with less than or equal to 0.1 wt% (equivalent to chlorine) of halogenated content. Flux having a strong acidity content should not be applied.</p> <p>(2) When soldering capacitors on the board, the amount of flux applied should be controlled at the optimum level.</p> <p>(3) When using water-soluble flux, special care should be taken to properly clean the boards.</p> <p>Soldering</p> <p>Temperature, time, amount of solder, etc. are specified in accordance with the following recommended conditions.</p> <p>And please contact us about peak temperature when you use lead-free paste.</p>	<p>1-1. When too much halogenated substance (Chlorine, etc.) content is used to activate the flux, or highly acidic flux is used, an excessive amount of residue after soldering may lead to corrosion of the terminal electrodes or degradation of insulation resistance on the surface of the capacitors.</p> <p>1-2. Flux is used to increase solderability in flow soldering, but if too much is applied, a large amount of flux gas may be emitted and may detrimentally affect solderability. To minimize the amount of flux applied, it is recommended to use a flux-bubbling system.</p> <p>1-3. Since the residue of water-soluble flux is easily dissolved by water content in the air, the residue on the surface of capacitors in high humidity conditions may cause a degradation of insulation resistance and therefore affect the reliability of the components. The cleaning methods and the capability of the machines used should also be considered carefully when selecting water-soluble flux.</p> <p>1-1. Preheating when soldering</p> <p>Heating: Ceramic chip components should be preheated to within 100 to 130°C of the soldering.</p> <p>Cooling: The temperature difference between the components and cleaning process should not be greater than 100°C.</p> <p>Ceramic chip capacitors are susceptible to thermal shock when exposed to rapid or concentrated heating or rapid cooling. Therefore, the soldering process must be conducted with great care so as to prevent malfunction of the components due to excessive thermal shock.</p> <p>Recommended conditions for soldering</p> <p>[Reflow soldering]</p> <p>Temperature profile</p>  <p>Caution</p> <p>1. The ideal condition is to have solder mass (fillet) controlled to 1/2 to 1/3 of the thickness of the capacitor, as shown below:</p>  <p>2. Because excessive dwell times can detrimentally affect solderability, soldering duration should be kept as close to recommended times as possible.</p> <p>[Wave soldering]</p> <p>Temperature profile</p>  <p>Caution</p> <ol style="list-style-type: none"> 1. Make sure the capacitors are preheated sufficiently. 2. The temperature difference between the capacitor and melted solder should not be greater than 100 to 130°C 3. Cooling after soldering should be as gradual as possible. 4. Wave soldering must not be applied to the capacitors designated as for reflow soldering only.

Precautions on the use of Multilayer Ceramic Capacitors

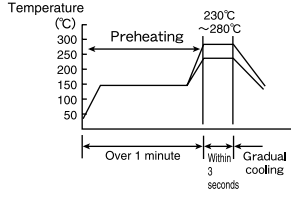
Stages	Precautions	Technical considerations						
4. Soldering		<p>[Hand soldering] Temperature profile</p>  <p>Caution</p> <ol style="list-style-type: none"> 1. Use a 20W soldering iron with a maximum tip diameter of 1.0 mm. 2. The soldering iron should not directly touch the capacitor. 						
5. Cleaning	<p>Cleaning conditions</p> <ol style="list-style-type: none"> 1. When cleaning the PC board after the capacitors are all mounted, select the appropriate cleaning solution according to the type of flux used and purpose of the cleaning (e.g. to remove soldering flux or other materials from the production process.) 2. Cleaning conditions should be determined after verifying, through a test run, that the cleaning process does not affect the capacitor's characteristics. 	<ol style="list-style-type: none"> 1. The use of inappropriate solutions can cause foreign substances such as flux residue to adhere to the capacitor or deteriorate the capacitor's outer coating, resulting in a degradation of the capacitor's electrical properties (especially insulation resistance). 2. Inappropriate cleaning conditions (insufficient or excessive cleaning) may detrimentally affect the performance of the capacitors. <p>(1)Excessive cleaning In the case of ultrasonic cleaning, too much power output can cause excessive vibration of the PC board which may lead to the cracking of the capacitor or the soldered portion, or decrease the terminal electrodes' strength. Thus the following conditions should be carefully checked;</p> <table border="0" data-bbox="906 993 1189 1070"> <tr> <td>Ultrasonic output</td> <td>Below 20 W/ℓ</td> </tr> <tr> <td>Ultrasonic frequency</td> <td>Below 40 kHz</td> </tr> <tr> <td>Ultrasonic washing period</td> <td>5 min. or less</td> </tr> </table>	Ultrasonic output	Below 20 W/ℓ	Ultrasonic frequency	Below 40 kHz	Ultrasonic washing period	5 min. or less
Ultrasonic output	Below 20 W/ℓ							
Ultrasonic frequency	Below 40 kHz							
Ultrasonic washing period	5 min. or less							
6. Post cleaning processes	<ol style="list-style-type: none"> 1. With some type of resins a decomposition gas or chemical reaction vapor may remain inside the resin during the hardening period or while left under normal storage conditions resulting in the deterioration of the capacitor's performance. 2. When a resin's hardening temperature is higher than the capacitor's operating temperature, the stresses generated by the excess heat may lead to capacitor damage or destruction. The use of such resins, molding materials etc. is not recommended. 							
7. Handling	<p>Breakaway PC boards (splitting along perforations)</p> <ol style="list-style-type: none"> 1. When splitting the PC board after mounting capacitors and other components, care is required so as not to give any stresses of deflection or twisting to the board. 2. Board separation should not be done manually, but by using the appropriate devices. <p>Mechanical considerations</p> <ol style="list-style-type: none"> 1. Be careful not to subject the capacitors to excessive mechanical shocks. <ol style="list-style-type: none"> (1)If ceramic capacitors are dropped onto the floor or a hard surface, they should not be used. (2)When handling the mounted boards, be careful that the mounted components do not come in contact with or bump against other boards or components. 							

Precautions on the use of Multilayer Ceramic Capacitors

Stages	Precautions	Technical considerations				
8.Storage conditions	<p>Storage</p> <p>1. To maintain the solderability of terminal electrodes and to keep the packaging material in good condition, care must be taken to control temperature and humidity in the storage area. Humidity should especially be kept as low as possible.</p> <ul style="list-style-type: none"> • Recommended conditions <table border="0" style="margin-left: 20px;"> <tr> <td>Ambient temperature</td> <td>Below 40°C</td> </tr> <tr> <td>Humidity</td> <td>Below 70% RH</td> </tr> </table> <p>The ambient temperature must be kept below 30°C. Even under ideal storage conditions capacitor electrode solderability decreases as time passes, so should be used within 6 months from the time of delivery.</p> <ul style="list-style-type: none"> • Ceramic chip capacitors should be kept where no chlorine or sulfur exists in the air. <p>2. The capacitance value of high dielectric constant capacitors (type 2 &3) will gradually decrease with the passage of time, so this should be taken into consideration in the circuit design. If such a capacitance reduction occurs, a heat treatment of 150°C for 1hour will return the capacitance to its initial level.</p>	Ambient temperature	Below 40°C	Humidity	Below 70% RH	<p>1. If the parts are stored in a high temperature and humidity environment, problems such as reduced solderability caused by oxidation of terminal electrodes and deterioration of taping/packaging materials may take place. For this reason, components should be used within 6 months from the time of delivery. If exceeding the above period, please check solderability before using the capacitors.</p>
Ambient temperature	Below 40°C					
Humidity	Below 70% RH					

高周波用円筒セラミックコンデンサ (セラチップ)

TUBULAR TYPE CERAMIC CAPACITORS (FOR HIGH FREQUENCY)

OPERATING TEMP. -25°C~+85°C

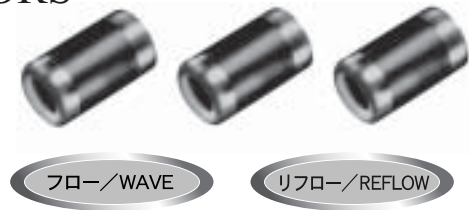

特長 FEATURES

- 高周波特性に優れる
 - インピーダンス特性が良好
 - 等価直列抵抗(ESR)が小さい
 - 高周波でのQ値が高い
 - ハンダくわれ・ぬれ性に対する端子電極対応により、ハンダ付けの信頼性に優れる
 - 耐熱衝撃性に優れる
 - 寸法安定性に優れ、高い実装性を誇る
 - 基板曲げ時の耐ベンディング性に優れる
 - チューナ特性に優れる
- Excellent high-frequency characteristics:
 - * Good impedance characteristics
 - * Low equivalent series resistance
 - * Large Q-value at high frequencies
 - Compatible with 0603 and 0805 component solder pad dimensions
 - Highly resistant to heat and impact
 - Excellent solderability and ability to withstand PCB bending
 - Excellent tuner characteristics

用途 APPLICATIONS

- 通信機器用
 - 携帯電話、PHS、コードレス電話etc
 - 民生機器用
 - チューナ、ビデオ、テレビetc
- Communications Equipment: portable telephones, PHS, other wireless applications, etc.
 - Consumer Electronic Appliances: tuners, video equipment, television sets, etc.

形名表記法 ORDERING CODE

1	4	5	6	7
定格電圧 (VDC)	温度特性 (ppm/°C)	公称静電容量 (pF)	容量許容差	包装
B 12 (16可) E 16 T 35 U 50	△A ± 5% △B ±10% △F ±30% △W ±10% △Y ±22%	例 0R5 0.5 010 1 682 6800 R=小数点	10pF以下 10pF超 C△ ± 0.25 pF D△ ± 0.5 pF F△ ± 1 pF J△ ± 5% K△ ± 10% M△ ± 20% N△ ± 30% Z△ ±80% -20%	△△ 単品(袋詰め) -2 テーピング -7 バルクカセット品 △=スペース
2 分類	C□ 0: CK,CJ,CH □許容差 R□ -220: RK,RJ,RH S□ -330: SK,SJ,SH H ± 60 T□ -470: TK,TJ,TH J ±120 U□ -750: UK,UJ K ±250 SL +350~-1000 L ±500 △=スペース		△=スペース	
3 形状寸法(mm)				
033 1.6×1.0 053 2.0×1.25				

U C N 0 3 3 C H 1 0 0 D △ - 2

1 2 3 4 5 6 7

1	4	5	6	7
Rated voltage(VDC)	Temperature characteristics(ppm/°C)	Nominal Capacitance(pF)	Capacitance Tolerances	Packaging
B 12 (Available up to 16) E 16 T 35 U 50	△A ± 5% △B ±10% △F ±30% △W ±10% △Y ±22%	0R5 0.5 010 1 682 6800 *R=decimal point	10pF≤ 10pF> C△ ± 0.25 pF D△ ± 0.5 pF F△ ± 1 pF J△ ± 5% K△ ± 10% M△ ± 20% N△ ± 30% Z△ ±80% -20%	△△ Bulk -2 Tape & reel -7 Bulk cassette △=Blank space
2 Type	C□ 0: CK,CJ,CH □=Tolerance R□ -220: RK,RJ,RH S□ -330: SK,SJ,SH H ± 60 T□ -470: TK,TJ,TH J ±120 U□ -750: UK,UJ K ±250 SL +350~-1000 L ±500 △=Blank space		△=Blank space	
3 External Dimensions(mm)				
033 1.6×1.0 053 2.0×1.25				

外形寸法 EXTERNAL DIMENSIONS

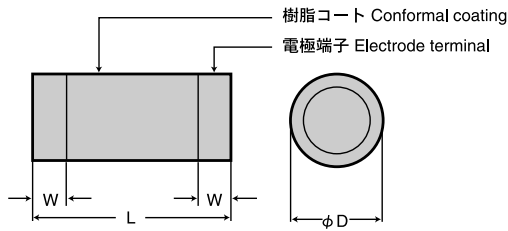

Type	L	φD	W
033	1.6 ^{+0.2} _{-0.1} (0.063 ^{+0.008} _{-0.004})	1.0±0.1 (0.039±0.004)	0.3±0.15 (0.012±0.006)
	2.0 ^{+0.2} _{-0.1} (0.079 ^{+0.008} _{-0.004})	1.25±0.2 (0.049±0.008)	0.3 ^{+0.2} _{-0.1} (0.012 ^{+0.008} _{-0.004})

Unit : mm(inch)

概略バリエーション AVAILABLE CAPACITANCE RANGE

Class1 (Temperature compensating)

WV		50V(UCN)											
Temp.char.	Type	C□		R□		S□		T□		U□		SL	
		033	053	033	053	033	053	033	053	033	053	033	053
Cap [pF]	[pF 3digits]												
0.5	0R5												
0.75	R75												
1	010												
1.5	1R5												
2	020												
2.5	2R5												
3	030												
3.5	3R5												
4	040												
4.5	4R5												
5	050												
6	060												
7	070												
8	080												
9	090												
10	100												
11	110												
12	120												
13	130												
15	150												
16	160												
18	180												
20	200												
22	220												
24	240												
27	270												
30	300												
33	330												
36	360												
39	390												
43	430												
47	470												
51	510												
56	560												
68	680												
75	750												
82	820												
91	910												
100	101												
120	121												
150	151												

Class2, 3 (High dielectric constant)

WV		50V(UCN)						35V(TCN)		16V(BCN)		16V(ECN)	
Temp.char.	Type	A		B		W		Y		Y		F	
		053	033	053	033	053	033	053	033	053	033	053	
Cap [pF]	[pF 3digits]												
68	680												
82	820												
100	101												
120	121												
150	151												
180	181												
220	221												
270	271												
330	331												
390	391												
470	471												
560	561												
680	681												
820	821												
1000	102												
1500	152												
2200	222												
3300	332												
4700	472												
5600	562												
6800	682												
8200	822												
10000	103												
15000	153												
22000	223												

仕様 SPECIFICATIONS

033Type

温度特性 Temp.char.	静電容量変化率 Capacitance Change	静電容量許容差 Capacitance Tolerance	Q or tanδ			
CK	0±250	0.5~5pF C(±0.25pF)	Q 400+20·Cmin (C≤27pF)			
RK	-220±250					
SK	-330±250					
TK	-470±250					
UK	-750±250					
CJ	0±120ppm/°C					
RJ	-220±120					
SJ	-330±120					
TJ	-470±120					
UJ	-750±120					
CH	0±60ppm/°C	11~91pF J(±5%)	100min (51≤C≤91pF)			
RH	-220±60					
SH	-330±60					
TH	-470±60					
SL	+350~-1000ppm/°C					
B	±10%			K(±10%)	tanδ 2.5%max	
W	±10%			M(±20%)		
Y	±22%			N(±30%)		
F	+30 -85%			Z(+80%)		tanδ 7.5%max
				Z(-20%)		

053Type

温度特性 Temp.char.	静電容量変化率 Capacitance Change	静電容量許容差 Capacitance Tolerance	Q or tanδ		
CK	0±250ppm/°C	0.5~5pF C(±0.25pF)	Q 400+20·Cmin (C≤27pF)		
RK	-220±250				
SK	-330±250				
TK	-470±250				
UK	-750±250				
CJ	0±120ppm/°C				
RJ	-220±120				
SJ	-330±120				
TJ	-470±120				
UJ	-750±120				
CH	0±60ppm/°C	11~56pF J(±5%)	500min (30≤C≤39pF)		
RH	-220±60				
SH	-330±60				
TH	-470±60				
SL	+350~-1000ppm/°C				
A	±5%			K(±10%)	tanδ 1.5%max
B	±10%			M(±20%)	
W	±10%			N(±30%)	
Y	±22%			N(±30%)	
F	+30 -85%			Z(+80%)	
		Z(-20%)			

セレクションガイド
Selection Guide

アイテム一覧
Part Numbers

特性図
Electrical Characteristics

梱包
Packaging

信頼性
Reliability Data

使用上の注意
Precautions



etc

033Type
Class1

定格電圧 Rated Voltage (DC)	形名 Ordering code	温度特性 Temperature characteristics	公称静電容量 Capacitance [pF]	静電容量許容差 Capacitance tolerance	Q or tanδ	絶縁抵抗 Insulation resistance	
50V	UCN033□0R5○	CK,RK SK,TK UK,SL	0.5	±0.25pF ±0.5 pF	Q≥400+20・C (C:静電容量) (C:capacitance)	10000MΩmin.	
	UCN033□R75○		0.75				
	UCN033□010○		1				
	UCN033□1R5○		1.5				
	UCN033□020○		2				
	UCN033□2R5○	CJ,RJ,SJ TJ,UJ,SL	2.5				
	UCN033□030○		3				
	UCN033□3R5○	CH RH SH TH UJ SL	3.5				±0.5pF ±1pF
	UCN033□040○		4				
	UCN033□4R5○		4.5				
	UCN033□050○		5				
	UCN033□060○		6				
	UCN033□070○		7				
	UCN033□080○		8				
	UCN033□090○		9				
	UCN033□100○		10				
	UCN033□110○		11	±5% ±10%			
	UCN033□120○	12					
	UCN033□130○	13					
	UCN033□150○	RH,SH,TH,UJ,SL	15				
	UCN033□160○	SH,TH,UJ,SL	16				
	UCN033□180○		18				
	UCN033□200○	TH,UJ,SL	20				
	UCN033□220○		22				
	UCN033□240○	UJ,SL	24				
	UCN033□270○		27				
	UCN033SL300○	SL	30	Q≥500			
	UCN033SL330○		33				
	UCN033SL360○		36				
	UCN033SL390○		39				
UCN033SL430○	43						
UCN033SL470○	47		Q≥100				
UCN033SL510○	51						
UCN033SL560○	56						
UCN033SL680○	68						
UCN033SL750○	75						
UCN033SL820○	82						
UCN033SL910○	91						
UCN033SL101○	100						

形名の□は温度特性記号、○は静電容量許容差記号が入ります。 □ Please specify the temperature characteristics and ○ capacitance tolerance code.

Class2,3

定格電圧 Rated Voltage (DC)	形名 Ordering code		温度特性 Temperature characteristics	公称静電容量 Capacitance (pF)	静電容量許容差 Capacitance tolerance	Q or tan δ	絶縁抵抗 Insulation resistance
50V	UCN033B121○		B	120	±10% ±20%	tan δ ≤ 2.5	10000M Ω min.
	UCN033B151○			150			
	UCN033B181○			180			
	UCN033B221○			220			
	UCN033B271○			270			
	UCN033B331○			330			
	UCN033W391○		W	390	±20% ±30%		
	UCN033W471○			470			
	UCN033W561○			560			
35V	TCN033Y681○		Y	680	±20% ±30%	tan δ ≤ 7.5%	1000M Ω min.
	TCN033Y821○			820			
	TCN033Y102○			1000			
	TCN033Y152○			1500			
	TCN033Y222○			2200			
16V	BCN033Y332○			3300			
	BCN033Y472○			4700			
	BCN033Y562○			5600			
	BCN033Y682○			6800			
	ECN033F103Z		F	10000	+80% -20%		

形名の□は温度特性記号、○は静電容量許容差記号が入ります。 □ Please specify the temperature characteristics and ○ capacitance tolerance code.

053Type
Class1

定格電圧 Rated Voltage (DC)	形名 Ordering code	温度特性 Temperature characteristics	公称静電容量 Capacitance [pF]	静電容量許容差 Capacitance tolerance	Q or tanδ	絶縁抵抗 Insulation resistance	
50V	UCN053□0R5○	CK,RK SK,TK UK,SL	0.5	±0.25pF ±0.5pF	Q≥400+20・C (C:静電容量) (C:capacitance)	10000MΩmin.	
	UCN053□R75○		0.75				
	UCN053□010○		1				
	UCN053□1R5○		1.5				
	UCN053□020○		2				
	UCN053□2R5○	CJ,RJ,SJ TJ,UJ,SL	2.5				
	UCN053□030○		3				
	UCN053□3R5○	CH RH SH TH UJ SL	3.5				±0.5pF ±1pF
	UCN053□040○		4				
	UCN053□4R5○		4.5				
	UCN053□050○		5				
	UCN053□060○		6				
	UCN053□070○		7				
	UCN053□080○		8				
	UCN053□090○		9				
	UCN053□100○		10				
	UCN053□110○		11				
	UCN053□120○		12	±5% ±10%			
	UCN053□130○	13					
	UCN053□150○	15					
	UCN053□160○	16					
	UCN053□180○	18					
	UCN053□200○	20					
	UCN053□220○	SH,TH,UJ,SL	22				
	UCN053□240○	TH,UJ,SL	24				
	UCN053□270○		27				
	UCN053□300○	UJ,SL	30		Q≥1000		
	UCN053SL330○	SL	33				
	UCN053SL360○		36				
	UCN053SL390○		39				
	UCN053SL430○		43				
	UCN053SL470○		47				
UCN053SL510○	51						
UCN053SL560○	56						
UCN053SL620○	62						
UCN053SL680○	68						
UCN053SL750○	75						
UCN053SL820○	82		Q≥500				
UCN053SL910○	91						
UCN053SL101○	100						
UCN053SL121○	120						
UCN053SL151○	150						
					Q≥100		

形名の□は温度特性記号、○は静電容量許容差記号が入ります。

□ Please specify the temperature characteristics and ○ capacitance tolerance code.

Class2、3

定格電圧 Rated Voltage (DC)	形名 Ordering code		温度特性 Temperature characteristics	公称静電容量 Capacitance [pF]	静電容量許容差 Capacitance tolerance	Q or tan δ	絶縁抵抗 Insulation resistance
50V	UCN053A680○		A	68	±10% ±20%	tan δ ≤ 1.5%	10000M Ω min.
	UCN053A820○			82			
	UCN053A101○			100			
	UCN053A121○			120			
	UCN053A151○			150			
	UCN053A181○			180			
	UCN053B221○		B	220	±10% ±20%	tan δ ≤ 1.5%	10000M Ω min.
	UCN053B271○			270			
	UCN053B331○			330			
	UCN053B391○			390			
	UCN053B471○			470			
	UCN053W561○		W	560	±20%	tan δ ≤ 2.5%	1000M Ω min.
	UCN053W681○			680	±30%		
UCN053W821○		820		±30%			
35V	TCN053Y681○		Y	680	±20% ±30%	tan δ ≤ 2.5%	1000M Ω min.
	TCN053Y821○			820			
	TCN053Y102○			1000			
	TCN053Y152○			1500			
	TCN053Y222○			2200			
16V	BCN053Y332○		Y	3300	±20% ±30%	tan δ ≤ 2.5%	1000M Ω min.
	BCN053Y472○			4700			
	BCN053Y682○			6800			
	BCN053Y822○			8200			
	ECN053F103Z		F	10000	+80% -20%	tan δ ≤ 7.5%	1000M Ω min.
	ECN053F153Z			15000			
	ECN053F223Z			22000			

形名の○は静電容量許容差記号が入ります。

○ Please specify the capacitance tolerance code.

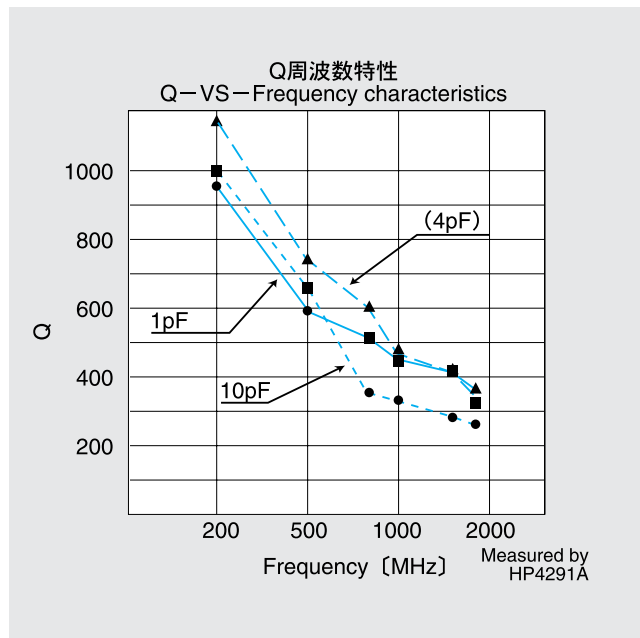
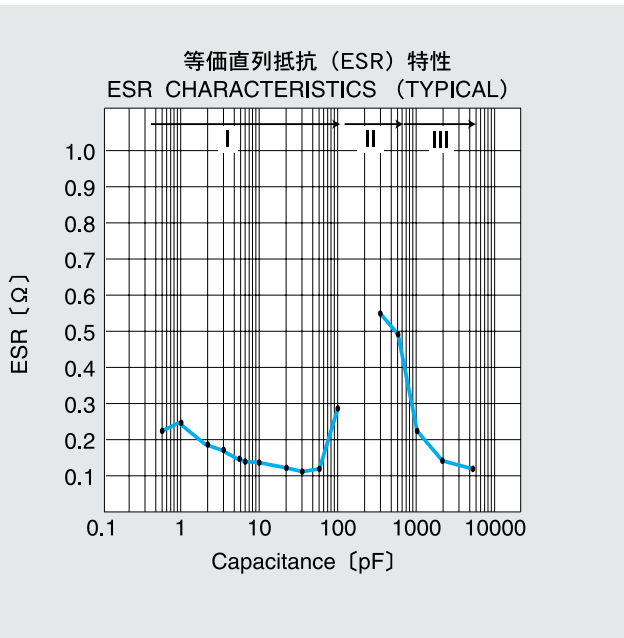

①標準数量 Standard quantity

形式 Type	標準数量(PCS) Standard quantity		
	袋づめ Bulk	バルクカセット Bulk cassette	テーピング Tape&Reel
033	5000	10000	3000
053	2000	6000	3000

②テーピング材質 Tape Material

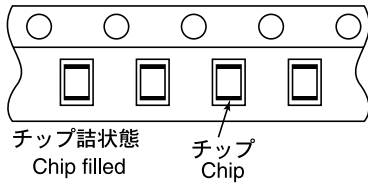
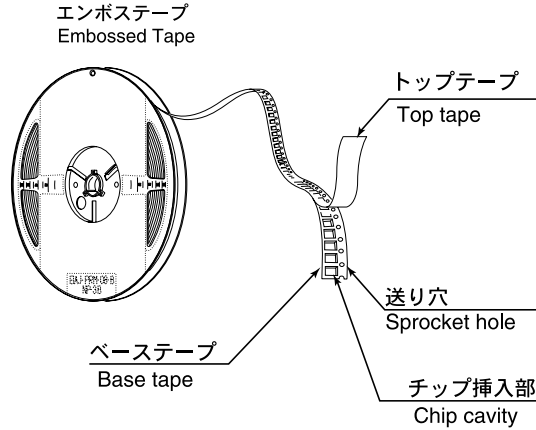

③テーピング寸法 Taping Dimensions

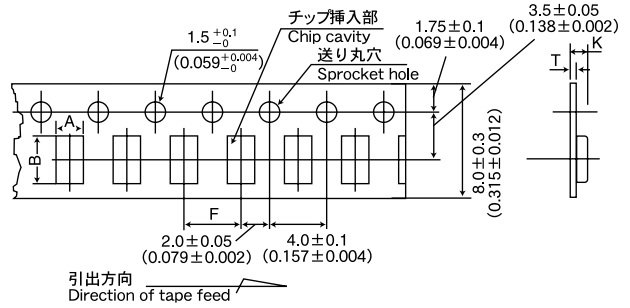

形式 Type	チップ挿入部 Chip cavity		挿入ピッチ Insertion Pitch	テープ厚み Tape Thickness	
	A	B	F	K	T
033	1.4 ± 0.1 (0.055 ± 0.004)	1.9 ± 0.2 (0.075 ± 0.008)	4.0 ± 0.1 (0.157 ± 0.004)	1.4max. (0.055max)	0.30max. (0.012max)
053	1.45 ± 0.1 (0.057 ± 0.004)	2.35 ± 0.2 (0.093 ± 0.008)	4.0 ± 0.1 (0.157 ± 0.004)	2.0max. (0.079max)	0.30max. (0.012max)

Unit : mm (inch)

④リーダー部/空部 Leader and Blank Portion

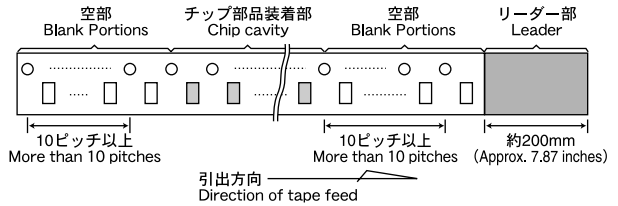

⑤リール寸法 Reel Size

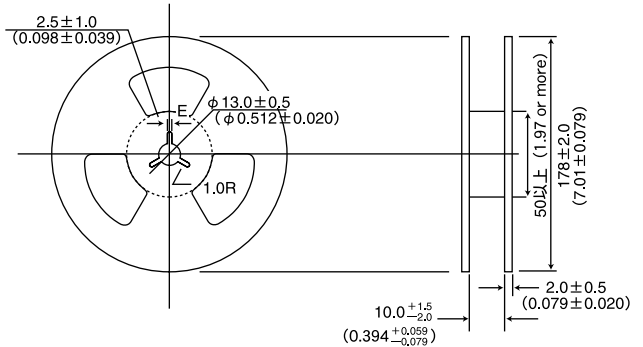

Unit = mm (inch)

⑥ トップテープ強度 Top Tape Strength

トップテープの剥離力は、下図矢印方向にて0.2~0.8Nとなります。

The top tape requires a peel-off force of 0.2 to 0.8N in the direction of the arrow as illustrated below.

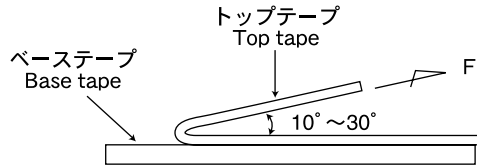

⑦ バルクカセット Bulk Cassette

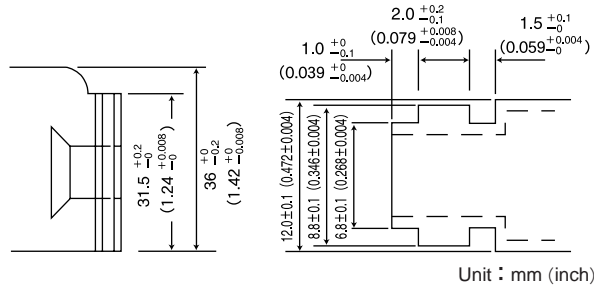
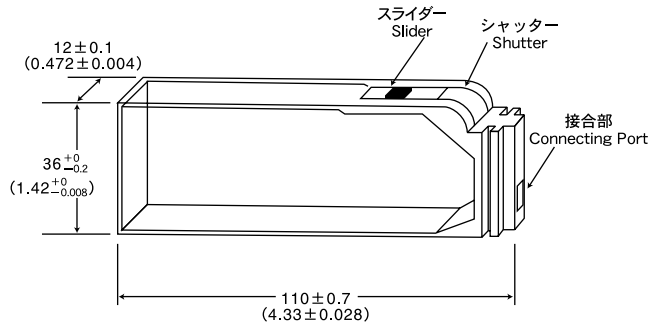

TUBULAR TYPE CERAMIC CAPACITORS

Item		Specified Value			Test Methods and Remarks
		Temperature Compensating (Class 1)	High Permittivity (Class 2)	Semiconductor (Class 3)	
		Tubular(*CN)	Tubular(*CN)	Tubular(*CN)	
1. Operating Temperature Range		-25 to +85°C	-25 to +85°C	-25 to +85°C	
2. Storage Temperature Range		-25 to +85°C	-25 to +85°C	-25 to +85°C	
3. Rated Voltage		50VDC	50VDC	50 VDC, 35 VDC, 16 VDC	
4. Withstanding Voltage	Between terminals	No abnormality	No abnormality	No abnormality	Tubular (*CN): Applied voltage: Rated voltage×3 (Class 1) Rated voltage×2.5 (Class 2) Rated voltage×2 (Class 3) Duration: 1 to 5 sec. Charge/discharge current: 50mA max. (Class 1,2) 10mA max. (Class 3)
5. Insulation Resistance		10000 MΩ min	10000 MΩ min	1000 MΩ min	Applied voltage: Rated voltage Duration: 60±5 sec. Charge/discharge current: 10mA max. (Class 3)
6. Capacitance		0.5 to 5 pF : ±0.25 pF ±0.5 pF 6 to 10 pF : ±0.5 pF ±1 pF 11 pF or over : ± 5% ±10%	±10% ±20%	±20%, ±30% +80% -20%	Tubular (*CN): Measuring frequency: 1MHz ±20%(Class 1) 1kHz ±20%(Class 2,3) Measuring voltage: 1 ±0.5Vrms (Class1,2,3) 0.1Vrms max (Class3:F) Bias application: None
7. Q or Tangent of Loss Angle (tan δ)		053: Under 30 pF : Q≥400 + 20C 30 pF or over : Q≥1000 SL, 43 pF or over : Q≥500 033: Under 30 pF : Q≥400 + 20C SL, 30 to 39 pF : Q≥500 SL, 43 to 100 pF : Q≥100 C= Nominal capacitance	A: 1.5% max. B: 2.5% max.	W,Y: 2.5% max.	Tubular (*CN): Measuring frequency: 1MHz±20% (Class 1) 1kHz±20% (Class 2,3) Measuring voltage: 1 ±0.5Vrms (Class1,2,3) 0.1Vrms max (Class3:F) Bias application: None

Withstanding voltage is also referred to as "voltage proof" under IEC specifications.

TUBULAR TYPE CERAMIC CAPACITORS

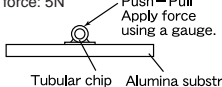
Item		Specified Value			Test Methods and Remarks
		Temperature Compensating (Class 1)	High Permittivity (Class 2)	Semiconductor (Class 3)	
		Tubular(*CN)	Tubular(*CN)	Tubular(*CN)	
8.Capacitance Change due to Temperature or Rate of Capacitance Change	(When voltage is not applied)	CK : 0±250	A : ±5%	W : ±10%	According to JIS C 5102 clause 7.12. Temperature compensating: Measurement of capacitance at 20°C and 85°C shall be made to calculate temperature characteristic by the following equation. $\frac{(C_{85}-C_{20})}{C_{20} \times \Delta T} \times 10^6 \text{ (ppm/}^\circ\text{C)}$ $\frac{(C_{-25}-C_{20})}{C_{20} \times \Delta T} \times 10^6 \text{ (ppm/}^\circ\text{C)}$ High permittivity and semiconductor types: Change of maximum capacitance deviation in step 1 to 5 Temperature at step 1: +20°C Temperature at step 2: -25°C Temperature at step 3: +20°C (Reference temperature) Temperature at step 4: +85°C Temperature at step 5: +20°C
		CJ : 0±120 CH : 0±60 RK : -220±250 RJ : -220±120 RH : -220±60 SK : -330±250 SJ : -330±120 SH : -330±60 TK : -470±250 TJ : -470±120 TH : -470±60 UK : -750±250 UJ : -750±120 SL : +350 to -1000 (ppm/°C)	B : ±10%	Y : ±22%	
9.Adhesion of Electrode	No damage	No damage	No damage	Tubular (*CN): Applied force: 5N  Tubular chip Alumina substrate (t = 1.0mm)	
10.Solderability	At least 80% of terminal electrodes is covered by new solder.	At least 80% of terminal electrodes is covered by new solder.	At least 80% of terminal electrodes is covered by new solder.	Tubular (*CN): According to JIS C 5102 clause 8.13. Solder temperature: 230±5°C Duration: 4±1 sec.	

TUBULAR TYPE CERAMIC CAPACITORS

Item	Specified Value			Test Methods and Remarks
	Temperature Compensating (Class 1)	High Permittivity (Class 2)	Semiconductor (Class 3)	
	Tubular(*CN)	Tubular(*CN)	Tubular(*CN)	
13.Damp Heat (steady state)	Appearance : No abnormality Capacitance change: Within $\pm 5\%$ or $\pm 0.5\text{pF}$, whichever is larger. Q(033): 0.5 to 9 pF : $Q \geq 200 + 10C$ 10 to 27 pF : $Q \geq 275 + 2.5C$ 30 to 39 pF : $Q \geq 250(\text{SL})$ 43 to 100 pF : $Q \geq 50(\text{SL})$ Q(053): $C \geq 30$ pF : $Q \geq 350$ $10 \leq C < 30$ pF : $Q \geq 275 + 2.5C$ $C < 10$ pF : $Q \geq 200 + 10C$ 053SL43 pF or over : $Q \geq 250$ C= Nominal capacitance Insulation resistance : 1000 M Ω min.	Appearance : No abnormality Capacitance change: A: Within $\pm 7.5\%$ B: Within $\pm 10\%$ tan δ : A : 3% max. B : 5% max. Insulation resistance: 1000 M Ω min.	Appearance : No abnormality Capacitance change: Within $\begin{matrix} +10 \\ -15 \end{matrix} \%$ tan δ : 5% max. Insulation resistance : 500 M Ω min. (033) 1000M Ω min (053)	Tubular (*CN033,053): Temperature: $40 \pm 2^\circ\text{C}$ Humidity: 90 to 95% RH Duration: $500 \begin{matrix} +24 \\ -0 \end{matrix}$ hrs Recovery: Recovery for the following period under the standard condition after the removal from test chamber. 24 \pm 2 hrs (Class 1) 48 \pm 4 hrs (Class 2,3)
14.Loading under Damp Heat	Appearance: No abnormality Capacitance change: Within $\pm 7.5\%$ or $\pm 0.75\text{pF}$, whichever is larger. Q(033): 0.5 to 27 pF : $Q \geq 100 + 10C/3$ 30 to 39 pF : $Q \geq 250(\text{SL})$ 43 to 100 pF : $Q \geq 30(\text{SL})$ Q(053): $C \geq 30$ pF : $Q \geq 200$ $C < 30$ pF : $Q \geq 100 + 10C/3$ 053SL43 pF or over: $Q \geq 150$ C= Nominal capacitance Insulation resistance: 500 M Ω min.	Appearance: No abnormality Capacitance change: A : Within $\pm 7.5\%$ B : Within $\pm 10\%$ tan δ : A : 5% max. B : 5% max. Insulation resistance: 500 M Ω min.	Appearance: No abnormality Capacitance change: Within $\begin{matrix} +10 \\ -15 \end{matrix} \%$ tan δ : 5% max. Insulation resistance: 250 M Ω min.	According to JIS C 5102 clause 9.9. Tubular (*CN): Temperature: $40 \pm 2^\circ\text{C}$ Humidity: 90 to 95% RH Duration: $500 \begin{matrix} +24 \\ -0 \end{matrix}$ hrs (*CN033,053) Applied voltage: Rated voltage Charge and discharge current: 50mA max. (Class 1,2) 10mA max. (Class 3) Recovery: Recovery for the following period under the standard condition after the removal from test chamber. As for Class 3, thermal treatment shall be performed prior to the recovery. 24 \pm 2 hrs (Class 1) 48 \pm 4 hrs (Class 2,3)

Withstanding voltage is also referred to as "voltage proof" under IEC specifications.

TUBULAR TYPE CERAMIC CAPACITORS

Item	Specified Value			Test Methods and Remarks
	Temperature Compensating (Class 1)	High Permittivity (Class 2)	Semiconductor (Class 3)	
	Tubular(*CN)	Tubular(*CN)	Tubular(*CN)	
15. Load Test under High Temp	Appearance: No abnormality Capacitance change: Within $\pm 3\%$ or $\pm 0.3\text{pF}$, whichever is larger. Q(033): 0.5 to 9 pF : $Q \geq 200 + 10C$ 10 to 27 pF : $Q \geq 275 + 2.5C$ 30 to 39 pF : $Q \geq 250(\text{SL})$ 43 to 100 pF : $Q \geq 50(\text{SL})$ Q(053): $C \geq 30$ pF : $Q \geq 350$ $10 \leq C < 30$ pF : $Q \geq 275 + 2.5C$ $C < 10$ pF : $Q \geq 200 + 10C$ 053SL43 pF or over : $Q \geq 250$ C = Nominal capacitance Insulation resistance: 1000 M Ω min.	Appearance: No abnormality Capacitance change: A: Within $\pm 7.5\%$ B: Within $\pm 10\%$ tan δ : A : 3% max. B : 4% max. Insulation resistance: 1000 M Ω min.	Appearance: No abnormality Capacitance change: Within $\begin{matrix} +10 \\ -15 \end{matrix}$ % tan δ : 5% max. Insulation resistance: 500 M Ω min.	According to JIS C 5102 clause 9.10. Tubular (*CN): Temperature: $85 \pm 2^\circ\text{C}$ Duration: $1000 \begin{matrix} +48 \\ 0 \end{matrix}$ hrs (*CN033,053) Applied voltage: Rated voltage $\times 2$ (Class 1,2) Rated voltage $\times 1.25$ (Class 3) Charge and discharge current: 50mA max. (Class 1,2) 10mA max. (Class 3) Recovery: Recovery for the following period under the standard condition after the removal from test chamber. As for Class 3, thermal treatment shall be performed prior to the recovery. 24 ± 2 hrs (Class 1) 48 ± 4 hrs (Class 2,3)

Note 1: Thermal treatment (Tubular/*CN Class3): 1 hr of thermal treatment at $120 \pm 3^\circ\text{C}$ followed by 4 hrs of recovery under the standard condition shall be performed before the measurement.

Note on standard condition: "standard condition" referred to herein is defined as follows:

5 to 35°C of temperature, 45 to 85% relative humidity and 86 to 106kPa of air pressure.

When there are questions concerning measurement results:

In order to provide correlation data, the test shall be conducted under condition of $20 \pm 2^\circ\text{C}$ of temperature, 60 to 70% relative humidity and 86 to 106kPa of air pressure.

Unless otherwise specified, all the tests are conducted under the "standard condition."







*Please specify the rated voltage code.

Withstanding voltage is also referred to as "voltage proof" under IEC specifications.

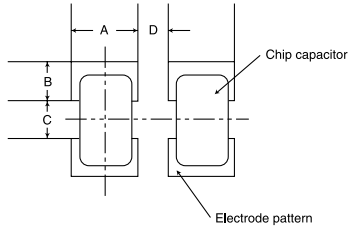
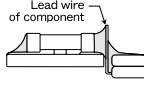
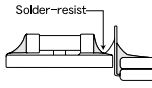
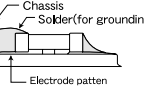
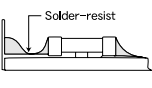
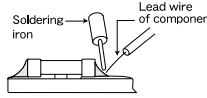
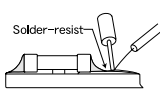
Precautions on the use of Tubular Type

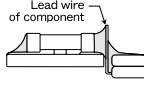
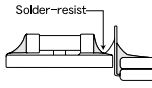
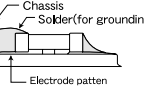
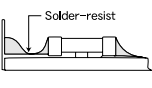
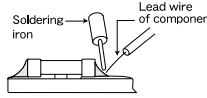
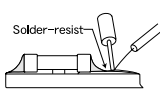
Stages	Precautions	Technical considerations
1. Circuit Design	<p>◆Verification of operating environment, electrical rating and performance</p> <p>1. A malfunction in medical equipment, spacecraft, nuclear reactors, etc. may cause serious harm to human life or have severe social ramifications. As such, any capacitors to be used in such equipment may require higher safety and/or reliability considerations and should be clearly differentiated from components used in general purpose applications.</p> <p>◆Operating Voltage (Verification of Rated voltage)</p> <p>1. The operating voltage for capacitors must always be lower than their rated values.</p> <p>If an AC voltage is loaded on a DC voltage, the sum of the two peak voltages should be lower than the rated value of the capacitor chosen. For a circuit where both an AC and a pulse voltage may be present, the sum of their peak voltages should also be lower than the capacitor's rated voltage.</p> <p>2. Even if the applied voltage is lower than the rated value, the reliability of capacitors might be reduced if either a high frequency AC voltage or a pulse voltage having rapid rise time is present in the circuit.</p> <p>◆Operating Current (Limitation in the current)</p> <p>1. General purpose capacitors are usually designed in a DC environment. Therefore, if capacitors are used in the circuits where AC or Pulse voltages are loaded, a large current running through the capacitor may result in a short-circuit due to self-generated heat.</p> <p>2. Class 3 capacitors have limitations in charging and discharging current. Therefore, if the current is overloaded it may cause the capacitor to short-circuit, burn or smoke.</p> <p>◆*Operating Environment precautions</p> <p>1. Capacitors should not be used in the following environments:</p> <p>(1)Environmental conditions to avoid</p> <ul style="list-style-type: none"> a. exposure to water or salt water. b. exposure to moisture or condensation. c. exposure to corrosive gases (such as hydrogen sulfide, sulfurous acid, chlorine, and ammonia) 	

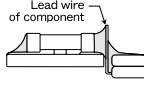
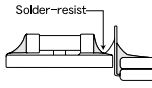
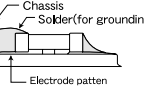
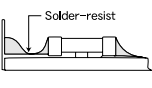
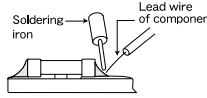
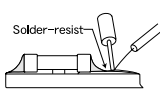
Precautions on the use of Tubular Type

Stages	Precautions	Technical considerations																																													
<p>2. PCB Design</p>	<p>◆Pattern configurations (Design of Land-patterns)</p> <p>1. When capacitors are mounted on a PCB, the amount of solder used (size of fillet) can directly affect capacitor performance. Therefore, the following items must be carefully considered in the design of solder land patterns:</p> <p>(1) The amount of solder applied can affect the ability of chips to withstand mechanical stresses which may lead to breaking or cracking. Therefore, when designing land-patterns it is necessary to consider the appropriate size and configuration of the solder pads which in turn determines the amount of solder necessary to form the fillets.</p> <p>(2) When more than one part is jointly soldered onto the same land or pad, the pad must be designed so that each component's soldering point is separated by solder-resist.</p>	<p>1. The following diagrams and tables show some examples of recommended patterns to prevent excessive solder amounts (larger fillets which extend above the component end terminations). Examples of improper pattern designs are also shown.</p> <p>(1) Recommended land dimensions for a typical chip capacitor Electrode patterns for PCBs</p>  <p>Recommended land patterns for wave soldering Unit: (mm)</p> <table border="1" data-bbox="850 753 1212 934"> <thead> <tr> <th>Type</th> <th>053</th> <th>033</th> </tr> </thead> <tbody> <tr> <td>Location A</td> <td>1.2</td> <td>1.0</td> </tr> <tr> <td>Location B</td> <td>1.2</td> <td>1.0</td> </tr> <tr> <td>Location C</td> <td>1.1</td> <td>0.8~1.0</td> </tr> <tr> <td>Location D</td> <td>1.0</td> <td>0.8</td> </tr> </tbody> </table> <p>Recommended land patterns for reflow soldering Unit: (mm)</p> <table border="1" data-bbox="850 982 1212 1164"> <thead> <tr> <th>Type</th> <th>053</th> <th>033</th> </tr> </thead> <tbody> <tr> <td>Location A</td> <td>1.2</td> <td>0.9</td> </tr> <tr> <td>Location B</td> <td>0.8</td> <td>0.6</td> </tr> <tr> <td>Location C</td> <td>1.0</td> <td>0.9</td> </tr> <tr> <td>Location D</td> <td>0.5 or more</td> <td>0.5 or more</td> </tr> </tbody> </table> <p>Notes;</p> <ol style="list-style-type: none"> When designing land patterns, rounded corners on the solder pad might result in better solderability. The size of the solder pad can vary depending on the part location and amount of solder. Therefore, please carefully consider location and solder amounts when designing solder pads. <p>• Examples of good and bad solder application</p> <table border="1" data-bbox="850 1452 1452 1900"> <thead> <tr> <th>Item</th> <th>Not recommended</th> <th>Lead wire of component</th> </tr> </thead> <tbody> <tr> <td>Mixe-mounting of SMD and leaded components</td> <td></td> <td></td> </tr> <tr> <td>Component placement close to the chassis</td> <td></td> <td></td> </tr> <tr> <td>Hand-soldering of leaded components near mounted components</td> <td></td> <td></td> </tr> <tr> <td>Horizontal component placement</td> <td></td> <td></td> </tr> </tbody> </table>	Type	053	033	Location A	1.2	1.0	Location B	1.2	1.0	Location C	1.1	0.8~1.0	Location D	1.0	0.8	Type	053	033	Location A	1.2	0.9	Location B	0.8	0.6	Location C	1.0	0.9	Location D	0.5 or more	0.5 or more	Item	Not recommended	Lead wire of component	Mixe-mounting of SMD and leaded components			Component placement close to the chassis			Hand-soldering of leaded components near mounted components			Horizontal component placement		
Type	053	033																																													
Location A	1.2	1.0																																													
Location B	1.2	1.0																																													
Location C	1.1	0.8~1.0																																													
Location D	1.0	0.8																																													
Type	053	033																																													
Location A	1.2	0.9																																													
Location B	0.8	0.6																																													
Location C	1.0	0.9																																													
Location D	0.5 or more	0.5 or more																																													
Item	Not recommended	Lead wire of component																																													
Mixe-mounting of SMD and leaded components																																															
Component placement close to the chassis																																															
Hand-soldering of leaded components near mounted components																																															
Horizontal component placement																																															

Precautions on the use of Tubular Type

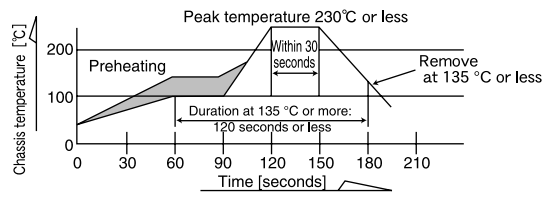
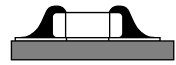
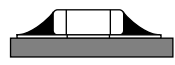
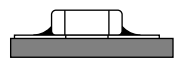
Stages	Precautions	Technical considerations
4. Soldering	<p>◆Selection of Flux</p> <ol style="list-style-type: none"> When soldering capacitors on the board, flux should be applied thinly and evenly. Flux used should be with less than or equal to 0.1 wt% (equivalent to Chlorine) of halogenated content. Flux having a strong acidity content should not be applied. When using water-soluble flux, special care should be taken to properly clean the boards. <p>◆Wave Soldering</p> <p>Temperature, time, amount of solder, etc. are specified in accordance with the following recommended conditions.</p> <p>◆Reflow Soldering</p> <ol style="list-style-type: none"> Temperature, time, amount of solder, etc. are specified in accordance with the following recommended conditions. The time between solder paste application and capacitor placement should be as short as possible The selection of appropriate solder materials is required. 	<ol style="list-style-type: none"> Flux is used to increase solderability in wave soldering, but if too much is applied, a large amount of flux gas may be emitted and may detrimentally affect solderability. To minimize the amount of flux applied, it is recommended to use a flux-bubbling system. With too much halogenated substance (Chlorine, etc.) content is used to activate the flux, an excessive amount of residue after soldering may lead to corrosion of the terminal electrodes or degradation of insulation resistance on the surface of the capacitors. Since the residue of water-soluble flux is easily dissolved by water content in the air, the residue on the surface of capacitors in high humidity conditions may cause a degradation of insulation resistance and therefore affect the reliability of the components. The cleaning methods and the capability of the machines used should also be considered carefully when selecting water-soluble flux. <p>1-1. If capacitors are used beyond the range of the following recommended conditions, heat stresses may cause cracks inside the capacitors, and consequently degrade the reliability of the capacitors. Above all, rapid heating/cooling or partial heating tend to be the major causes of cracks.</p> <p>[Examples of reflow soldering]</p>  <ol style="list-style-type: none"> Excessively long soldering times or high soldering temperatures may cause separation of the terminations from chip bodies, or leakage of capacity. If solder paste is left exposed for a long period of time before capacitors are placed the surface dries out and a membrane film will form on the board surface causing a considerable reduction in solderability. During the reflow process, when too much solder paste is applied excess solder mass can produce mechanical and heat stresses on the capacitors and may consequently result in the breakage or cracking of the components. On the other hand, too little solder paste will weaken the adhesion characteristics and may consequently cause separation of components and degrade the circuit reliability. <div style="display: flex; justify-content: space-around;"> <div style="text-align: center;"> <p>(a) Too much solder</p>  </div> <div style="text-align: center;"> <p>(b) Appropriate amount of solder</p>  </div> <div style="text-align: center;"> <p>(c) Too little solder</p>  </div> </div> <ol style="list-style-type: none"> With inappropriate solder materials, solder balls may form. These solder balls must be thoroughly removed, since the balls would cause a reduction in capacitor electrical characteristics or degradation of reliability.

Precautions on the use of Tubular Type

Stages	Precautions	Technical considerations						
<p>4. Soldering</p>	<p>◆Hand soldering with iron</p> <ol style="list-style-type: none"> Temperature, time, amount of solder, etc. are specified in accordance with the following recommended conditions. When touch-up work is required for repair, preheating must be conducted with appropriate temperature control. Special attention should be paid to the diameter of the soldering iron tip and wattage when additional part mounting or repair work takes place. The solder iron should only directly touch the external electrodes. Amount of solder should be applied at the appropriate level. 	<ol style="list-style-type: none"> If capacitors are used beyond the range of the following recommended conditions, heat stresses may cause cracks inside the capacitors, and consequently degrade the reliability of the capacitors. Above all, rapid heating/cooling or partial heating tend to be the major causes of cracks. Recommended conditions for solder iron touch-up [Example of soldering iron] <table border="1" data-bbox="847 417 1453 497"> <thead> <tr> <th>Soldering iron's temperature [°C]</th> <th>Watt [W]</th> <th>Iron tip dia. [mm]</th> </tr> </thead> <tbody> <tr> <td>Below 270</td> <td>Below 20</td> <td>Below 3.0 in diameter</td> </tr> </tbody> </table> <p>Temperature range between iron tip and preheating temperature. 130°C or less Duration 3 seconds or less Number of times 3 times or less</p> <ol style="list-style-type: none"> Selection of soldering irons Temperature at the tip of the soldering iron varies depending on the type of soldering iron. If the temperature at the tip of the soldering iron is too high thermal stresses may cause cracks in the component. If the soldering iron tip touches the ceramic material directly, the component may develop heat stresses, and cracks. During the solder iron process, when too much solder is used it can result in mechanical and heat stresses on the capacitors and may consequently result in the breakage or cracking of the components. On the other hand, too little solder will weaken the adhesion characteristics and may consequently cause separation of components and degrade the circuit reliability. <p>(Appropriate application of soldering iron) (Appropriate amount of solder)</p> 	Soldering iron's temperature [°C]	Watt [W]	Iron tip dia. [mm]	Below 270	Below 20	Below 3.0 in diameter
Soldering iron's temperature [°C]	Watt [W]	Iron tip dia. [mm]						
Below 270	Below 20	Below 3.0 in diameter						
<p>5. Cleaning</p>	<p>◆Board cleaning</p> <ol style="list-style-type: none"> When using ultrasonic cleaning on PC boards with capacitors, avoid subjecting the PCB directly to vibration. Special attention should be paid to output frequency and duration of ultrasonic cleaning. Cleaning conditions should be determined after verifying, through a test run, that the cleaning process does not affect the capacitor's characteristics. 	<ol style="list-style-type: none"> In the case of ultrasonic cleaning, too much power output can cause excessive vibration of the PC board which may lead to the cracking of the capacitor or the soldered portion, or decrease the terminal electrodes' strength. Thus the following conditions should be carefully checked; <table border="1" data-bbox="879 1203 1209 1284"> <tbody> <tr> <td>Ultrasonic output</td> <td>Below 20 W/l</td> </tr> <tr> <td>Ultrasonic frequency</td> <td>Below 40 kHz</td> </tr> <tr> <td>Ultrasonic cleaning period</td> <td>5 min. or less</td> </tr> </tbody> </table> In case of insufficient cleaning <ol style="list-style-type: none"> The halogenated content in the flux residue may lead to corrosion of the terminal electrodes or degradation of insulation resistance. When using water-soluble flux, it may degrade insulation resistance characteristics of the capacitor surface. 	Ultrasonic output	Below 20 W/l	Ultrasonic frequency	Below 40 kHz	Ultrasonic cleaning period	5 min. or less
Ultrasonic output	Below 20 W/l							
Ultrasonic frequency	Below 40 kHz							
Ultrasonic cleaning period	5 min. or less							
<p>6. Post cleaning processes</p>	<p>◆Application of resin molding, etc. to the PCB and components.</p> <ol style="list-style-type: none"> Please contact your local Taiyo Yuden sales office before performing resin coating or molding on mounted capacitors. 	<ol style="list-style-type: none"> 1-1. When a resin's hardening temperature is higher than the capacitor's operating temperature, the stresses generated by the excess heat may lead to capacitor damage or destruction. 1-2. With some type of resins a decomposition gas or chemical reaction vapor may remain inside the resin during the hardening period or while left under normal storage conditions resulting in the deterioration of the capacitor's performance. 1-3. Some types of coating or molding material may degrade humidity resistance. Therefore, it is highly recommended you contact the material manufacturer before using. 						

Precautions on the use of Tubular Type

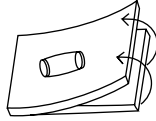
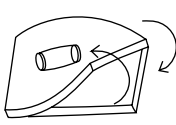
Stages	Precautions	Technical considerations
7. Handling	<p>◆Breakaway PC boards (splitting along perforations)</p> <ol style="list-style-type: none"> When splitting the PC board after mounting capacitors and other components, care is required so as not to give any stresses of deflection or twisting to the board. Board separation should not be done manually, but by using the appropriate devices. <p>◆Mechanical considerations</p> <ol style="list-style-type: none"> Be careful not to subject the capacitors to excessive mechanical shocks. If ceramic capacitors are dropped on the floor or a hard surface they should not be used. 	<ol style="list-style-type: none"> If the board is subjected to the stresses of deflection and twisting (as shown below) when splitting or breaking away the boards, it may cause cracks in the board. <div style="display: flex; justify-content: space-around; align-items: center;"> <div style="text-align: center;"> <p>Deflection</p>  </div> <div style="text-align: center;"> <p>Twisting</p>  </div> </div> <ol style="list-style-type: none"> Because the capacitor is made of ceramic, mechanical shocks applied to the board may damage or crack the capacitors. Ceramic capacitors which are dropped onto the floor or a hard surface may develop defects and have a higher risk of failure over time.
8. Storage conditions	<p>◆Storage</p> <ol style="list-style-type: none"> To maintain the solderability of terminal electrodes and to keep the packaging material in good condition, care must be taken to control temperature and humidity in the storage area. Humidity should especially be kept as low as possible. Recommended conditions: Ambient temperature Below 40 deg °C Humidity Below 70% RH Capacitors should not be kept in an environment filled with decomposition gases such as (sulfurous hydrogen, sulfuric acid, chlorine, ammonia, etc.) Capacitors should not be kept in a location where they may be exposed to moisture, condensation or direct sunlight. 	<ol style="list-style-type: none"> Under high temperature/high humidity conditions, the decrease in solderability due to the oxidation of terminal electrodes and deterioration of taping and packaging characteristics may be accelerated, so the products should be used within 6 months after delivery. After the above period, the solderability should be checked before using the capacitors. Harmful gasses in the ambient air may also degrade the solderability of the terminal electrodes resulting in a deterioration of the capacitor's reliability. Direct sunlight, the photochemical effect of resin coatings, or a rapid change in the humidity may cause condensation on or around the terminals. So special care must be taken to prevent reduced solderability or performance of the capacitors.

アキシャルリード形セラミックコンデンサ AXIAL LEADED CERAMIC CAPACITORS

OPERATING TEMP. -25~+85°C



特長 FEATURES

- 汎用型セラミックコンデンサで、単層形と積層形合わせて1pF~1μFと広い容量範囲で部品の標準化が可能
- ラジアルに比べ自挿コストが安く、部品高さ低減、実装密度アップ、在庫スペースも減少
- This widely used ceramic capacitor includes both monolithic and multilayer types to provide a wide capacitance range of 1pF through 1uF in one standard size and shape.
- Automatic insertion related costs are lower than with radial type capacitors.

用途 APPLICATIONS

- Class1品は回路の温度特性補正及び周波数特性の安定化。B、X、Y、F特はバイパスコンデンサに最適
- The class 1 temperature compensating (NPO) products can be used in circuits to stabilize frequency and temperature characteristics.
- The B, X, Y and F dielectrics are optimum for bypass capacitors.

形名表記法 ORDERING CODE

1 定格電圧 (VDC)	E 16 T 25 U 50	4 温度特性	CH 0± 60(ppm /C) RH -220± 60(ppm /C) UJ -750±120(ppm /C) SL +350~-1000(ppm /C) △B (Y5P) ±10% (単層形) (X5R) ±15% (積層形) △F (Y5V) $\pm \frac{30}{85}\%$ △X (Y5R) ±15% △Y (Y5S) ±22% △=スペース	5 公称静電容量 (pF)	例 ※R=小数点 010 1 1R2 1.2 103 10000	6 容量許容差 (%)	J- ± 5 K- ±10 M- ±20 N- ±30 Z- ±80	8 梱包	B つづら折り C 袋づめ
2 形式	P アキシャルリードコンデンサ					7 リード形状 (mm)	A- 26.0テープ幅テーピング B- 52.0テープ幅テーピング KE 7.5ピッチフォーミング (単層タイプ) KF 5.0ピッチフォーミング NA 単品ストレートリード	9 当社管理記号	△△ 単層標準品 Z△ 積層標準品 △=スペース
3 形状寸法 (L×φd)(mm)	050 3.5×1.9(単層形) 3.2×2.2(積層形)								



1 Rated voltage(VDC)	E 16 T 25 U 50	4 Temperature characteristics(ppm/C)	CH 0± 60 RH -220± 60 UJ -750±120 SL +350~-1000 △B (Y5P) ±10% (monolithic type) (X5R) ±15% (multilayer type) △F (Y5V) $\pm \frac{30}{85}\%$ △X (Y5R) ±15% △Y (Y5S) ±22% △=Blank space	5 Nominal Capacitance(pF)	example 010 1 1R2 1.2 103 10000 ※R=decimal point	6 Capacitance Tolerances(%)	J- ± 5 K- ±10 M- ±20 N- ±30 Z- ±80	8 Packaging	B Ammo C Bulk
2 Type	P Axial leaded capacitors					7 Lead Configuration	A- 26mm lead space, ammo pack B- 52mm lead space, ammo pack KE 7.5mm pitch formed lead bulk(monolithic type) KF 5.0mm pitch formed lead bulk NA Axial lead, bulk	9 Internal code	△△ Monolithic type Standard products Z△ Multilayer type Standard products △=Blank space
3 Outside Dimensions(L×φd)(mm)	050 3.5×1.9(monolithic type) 3.2×2.2(multilayer type)								

外形寸法 EXTERNAL DIMENSIONS

TYPE	Dimensions			テーピング品 Taped product		単品 Bulk Product		
	L	φD	φd	ストレート Straight	ストレート Straight	フォーミング Formed	フォーミング Formed	フォーミング Formed
単層形050 (Monolithic Type)	3.5max (0.138max)	1.9max (0.075max)	0.45±0.05 (0.018±0.002)					
積層形050 (Multilayer Type)	3.2max (0.126max)	2.2max (0.087max)						

Unit: mm(inch)

概略バリエーション AVAILABLE CAPACITANCE RANGE

Class 1 (Temperature compensating)					Class 2, 3 (High dielectric constant)							
WV		50V(UP)				WV		50V(UP)		25V (TP)	16V (EP)	
Temp.char.		CH	RH	UJ	SL	Temp.char.		B	F	F	X	Y
Cap						Cap						
[pF]	[pF : 3digits]					[pF]	[pF : 3digits]					
1	010					75	750					
1.2	1R2					82	820					
1.5	1R5					91	910					
1.8	1R8					100	101					
2.2	2R2					120	121					
2.7	2R7					150	151					
3.3	3R3					180	181					
3.9	3R9					220	221					
4.7	4R7					270	271					
5.6	5R6					330	331					
6.8	6R8					390	391					
8.2	8R2					470	471					
10	100					560	561					
11	110					680	681					
12	120					820	821					
13	130					1000	102					
15	150					1200	122					
16	160					1500	152					
18	180					1800	182					
20	200					2200	222					
22	220					2700	272					
24	240					3300	332					
27	270					3900	392					
30	300					4700	472					
33	330					5600	562					
36	360					6800	682					
39	390					8200	822					
43	430					10000	103					
47	470					22000	223					
51	510					33000	333					
56	560					47000	473					
62	620					68000	683					
68	680					100000	104					
100	101					220000	224					
150	151					470000	474					
220	221					1000000	105					
330	331											
470	471											
680	681											
1000	102											

温度特性 Temperature char.	静電容量変化率 Capacitance change	容量許容差 Capacitance Tolerance	Q又はtanδ Q or tanδ	種類 Class
CH	0± 60ppm/°C	1.8pF(and less) : M(±20%) 2.2~8.2pF : K(±10%) 10pF(or over) : J(±5%)	単層タイプ(Monolithic Type) Q≥400+20C 積層タイプ(Multilayer Type) Q≥400+20C, 33pF(and over) Q≥1000 Q≥400+20・C, 16pF(and over) Q≥500 Q≥400+20・C	1
RH	-220± 60ppm/°C	K (±10%)	単層タイプ(Monolithic Type) tanδ≤1.5%, 470pF(and over)tanδ≤2.5%	2, 3
UJ	-750±120ppm/°C		積層タイプ(Multilayer Type) 1200pF~39000pF : tanδ≤3.5% 47000pF~100000pF : tanδ≤5.0%	
SL	+350~-1000ppm/°C		単層タイプ(Monolithic Type) tanδ≤2.5%	3
			積層タイプ(Multilayer Type) tanδ≤7.5%	3
△B	Y5P : ±10% X5R : ±15%	M(±20%)、N(±30%) M(±20%)、N(±30%)	単層タイプ(Monolithic Type) tanδ≤7.5% 積層(Multilayer Type) 10000pF~100000pF : tanδ≤7.5% 220000pF~470000pF : tanδ≤10.0% 1000000pF : tanδ≤15.0%	2
X(Y5R)	±15%			
Y(Y5S)	±22%			
△F	Y5V : ±30%	Z(±30%)		

注1: 温度特性の()はEIA規格相当表示です。
注2: 20°Cにおける静電容量を基準。

Note 1: Temperature characteristics in () are EIA Standard.
Note 2: Capacitance characteristics measured at 20°C

セレクションガイド
Selection Guide

アイテム一覧
Part Numbers

特性図
Electrical Characteristics

梱包
Packaging

信頼性
Reliability Data

使用上の注意
Precautions



etc

アイテム一覧 PART NUMBERS

[単層タイプ Monolithic type]

Class 1

定格電圧 Rated Voltage (DC)	形名 Ordering code		温度特性 Temperature characteristics	公称静電容量 Capacitance [pF]	容量許容差 Capacitance tolerance	Q or tanδ	絶縁抵抗 Insulation resistance
50V	UP050□010M-○		CH RH SL	1.0	±20%	Q≥400+20C (C:公称静電容量 capacitance[pF]) ただしRHは 16pF以上は Q≥500 but Q≥500 at 16pF or over of characteristic RH	10000MΩmin
	UP050□1R2M-○			1.2			
	UP050□1R5M-○			1.5			
	UP050□1R8M-○		1.8	±10%			
	UP050□2R2K-○		2.2				
	UP050□2R7K-○		2.7				
	UP050□3R3K-○		3.3				
	UP050□3R9K-○		3.9				
	UP050□4R7K-○		4.7				
	UP050□5R6K-○		5.6				
	UP050□6R8K-○		6.8				
	UP050□8R2K-○		8.2				
	UP050□100J-○		10		±5%		
	UP050□110J-○		11				
	UP050□120J-○		12				
	UP050□130J-○		13				
	UP050□150J-○		15				
	UP050□160J-○		16				
	UP050□180J-○		18				
	UP050□200J-○		CH、UJ、SL	20			
	UP050□220J-○		UJ SL	22			
	UP050□240J-○			24			
	UP050□270J-○			27			
	UP050□300J-○		SL	30	Q≥500		
	UP050SL330J-○			33			
	UP050SL360J-○			36			
	UP050SL390J-○			39			
	UP050SL430J-○			43			
UP050SL470J-○		47					
UP050SL510J-○		51					
UP050SL560J-○		56					
UP050SL620J-○		62					
UP050SL680J-○		68					

[積層タイプ Multilayer type]

Class 1

定格電圧 Rated Voltage (DC)	形名 Ordering code	温度特性 Temperature characteristics	公称静電容量 Capacitance [pF]	容量許容差 Capacitance tolerance	Q or tanδ	絶縁抵抗 Insulation resistance
50V	★ UP050CH220J-○Z	CH	22	± 5%	Q _≥ 400+20C	10000MΩmin
	★ UP050CH240J-○Z		24			
	★ UP050CH270J-○Z		27			
	★ UP050CH300J-○Z		30			
	★ UP050CH330J-○Z		33			
	★ UP050CH360J-○Z		36			
	★ UP050CH390J-○Z		39			
	★ UP050CH430J-○Z		43			
	★ UP050CH470J-○Z		47			
	★ UP050CH510J-○Z		51			
	★ UP050CH560J-○Z		56			
	★ UP050CH620J-○Z		62			
	★ UP050CH680J-○Z		68			
	★ UP050CH750J-○Z		75			
	★ UP050CH820J-○Z		82			
	★ UP050CH910J-○Z		91			
	★ UP050CH101J-○Z		100			
	★ UP050CH111J-○Z		110			
	★ UP050CH121J-○Z		120			
	★ UP050CH131J-○Z		130			
	★ UP050CH151J-○Z		150			
	★ UP050CH161J-○Z		160			
	★ UP050CH181J-○Z		180			
	★ UP050CH201J-○Z		200			
	★ UP050CH221J-○Z		220			
	★ UP050CH241J-○Z		240			
	★ UP050CH271J-○Z		270			
	★ UP050CH301J-○Z		300			
	★ UP050CH331J-○Z		330			
	★ UP050CH361J-○Z		360			
	★ UP050CH391J-○Z		390			
	★ UP050CH431-○Z		430			
	★ UP050CH471J-○Z		470			
★ UP050CH511J-○Z	510					
★ UP050CH561J-○Z	560					
★ UP050CH621J-○Z	620					
★ UP050CH681J-○Z	680					
★ UP050CH751J-○Z	750					
★ UP050CH821J-○Z	820					
★ UP050CH911J-○Z	910					
★ UP050CH102J-○Z	1000					

形名の□には温度特性、○にはリード形状分類記号が入ります。★：オプション対応

□Please specify the temperature characteristics code and ○ lead configuration code.

★ : Option

アイテム一覧 PART NUMBERS

[単層タイプ Monolithic type]
Class 2, 3

定格電圧 Rated Voltage (DC)	形名 Ordering code		温度特性 Temperature characteristics	公称静電容量 Capacitance [pF]	容量許容差 Capacitance tolerance	Q or $\tan\delta$	絶縁抵抗 Insulation resistance
50V	UP050B750K-○		B	75	±10%	$\tan\delta \leq 1.5\%$	10000MΩmin
	UP050B820K-○			82			
	UP050B910K-○			91			
	UP050B101K-○			100			
	UP050B121K-○			120			
	UP050B151K-○			150			
	UP050B181K-○			180			
	UP050B221K-○			220			
	UP050B271K-○			270			
	UP050B331K-○			330			
	UP050B391K-○			390			
	UP050B471K-○			470			
	UP050B561K-○			560			
	UP050B681K-○			680			
	UP050B821K-○			820			
UP050B102K-○		1000					
16V	EP050X122△-○		X	1200	±20% ±30%	$\tan\delta \leq 2.5\%$	1000MΩmin
	EP050X152△-○			1500			
	EP050X182△-○			1800			
	EP050X222△-○			2200			
	EP050X272△-○			2700			
	EP050X332△-○			3300			
	EP050X392△-○			3900			
	EP050X472△-○			4700			
	EP050X562△-○			5600			
	EP050X682△-○			6800			
	EP050Y822△-○			8200			
	EP050Y103△-○			10000			
25V	TP050F103Z-○		F	10000	± ⁸⁰ / ₂₀ %	$\tan\delta \leq 7.5\%$	
	TP050F223Z-○			22000			

[積層タイプ Multilayer type]

Class 2

定格電圧 Rated Voltage (DC)	形名 Ordering code	温度特性 Temperature characteristics	公称静電容量 Capacitance [pF]	容量許容差 Capacitance tolerance	Q or tanδ	絶縁抵抗 Insulation resistance
50V	★ UP050B122K-○Z	B	1200	±10%	tanδ ≤ 3.5%	5000MΩmin
	UP050B152K-○Z		1500			
	★ UP050B182K-○Z		1800			
	UP050B222K-○Z		2200			
	★ UP050B272K-○Z		2700			
	UP050B332K-○Z		3300			
	★ UP050B392K-○Z		3900			
	UP050B472K-○Z		4700			
	★ UP050B562K-○Z		5600			
	UP050B682K-○Z		6800			
	★ UP050B822K-○Z		8200			
	UP050B103K-○Z		10000			
	★ UP050B123K-○Z		12000			
	UP050B153K-○Z		15000			
	★ UP050B183K-○Z		18000			
	UP050B223K-○Z		22000			
	★ UP050B273K-○Z		27000			
	UP050B333K-○Z		33000			
	★ UP050B393K-○Z		39000			
	UP050B473K-○Z		47000			
★ UP050B563K-○Z	56000					
UP050B683K-○Z	68000					
★ UP050B823K-○Z	82000					
UP050B104K-○Z	100000					
50V	UP050F103Z-○Z	F	10000	+80 -20 %	tanδ ≤ 7.5%	1000MΩmin
	UP050F223Z-○Z		22000			
	UP050F473Z-○Z		47000			
	UP050F104Z-○Z		100000		tanδ ≤ 10.0%	500MΩmin
	UP050F224Z-○Z		220000			
	UP050F474Z-○Z		470000			
	UP050F105Z-○Z		1000000			

形名の△には容量許容差、○にはリード形状分類記号が入ります。 ★：オプション対応

△Please specify the capacitance tolerance code and ○ lead configuration code.

★ : Option

・静電容量—温度特性 Capacitance -vs- Temperature Characteristics

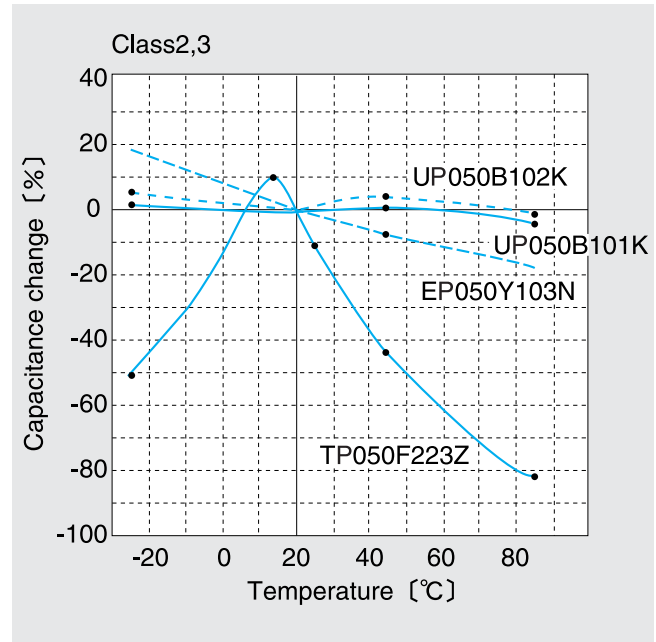
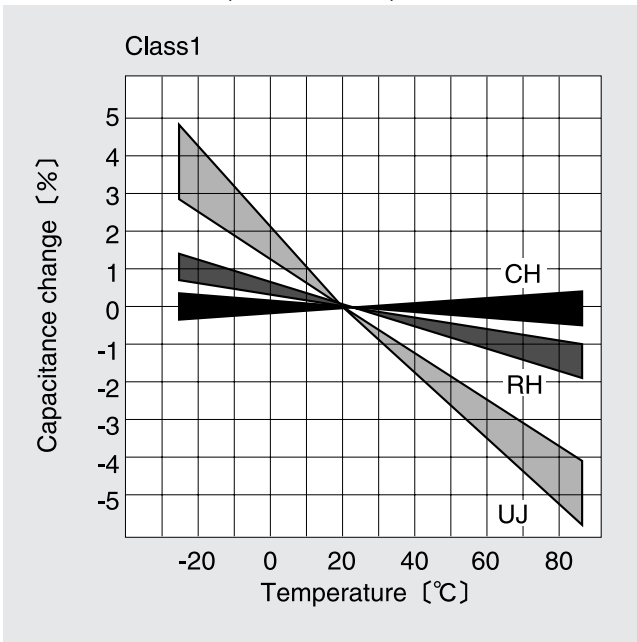

①標準数量 Standard quantity

形式 Type	リード形状記号 Lead configuration code	標準数量(PCS) Standard quantity	
		袋づめ Bulk	テーピング Taping
積層形 Multilayer type	A-(26mm幅) 1.024 inch wide	—	3000
	B-(52mm幅) 2.047 inches wide	—	3000
	NA	1000	—
	KF	3000	—
単層形 Monolithic type	A-(26mm幅) 1.024 inch wide	—	4000
	B-(52mm幅) 2.047 inches wide	—	4000
	NA	1000	—
	KF	3000	—
	KE	3000	—

②製品単品形状 Dimensions of Bulk Products

・NA形状 NA configuration

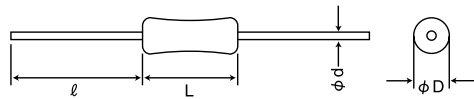

形式 Type	寸法 Dimensions(mm)			
	φD	L	φd	ℓ
積層形 Multilayer type	2.2max (0.087)	3.2max (0.126)	0.45±0.05 (0.018±0.002)	20.0min (0.787)
単層形 Monolithic type	1.9max (0.075)	3.5max (0.138)	0.45±0.05 (0.018±0.002)	20.0min (0.787)

Unit : mm(inch)

・KF/KE形状 KF/KE configuration

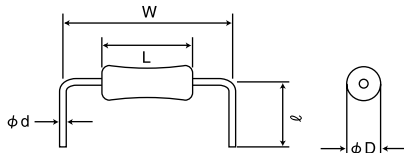

形式 Type	リード形状記号 Lead configuration code	寸法 Dimensions(mm)				
		φD	L	W	φd	ℓ
積層形 Multilayer type	KF	2.2max (0.087max)	3.2max (0.126max)	5.0±0.5 (0.197±0.020)	0.45±0.05 (0.018±0.020)	6.5±0.5 (0.256±0.020)
単層形 Monolithic type	KF	1.9max (0.075max)	3.5max (0.138max)	5.0±0.5 (0.197±0.020)	0.45±0.05 (0.018±0.020)	6.5±0.5 (0.256±0.020)
単層形 Monolithic type	KE	1.9max (0.075max)	3.5max (0.138max)	7.5±0.5 (0.295±0.020)	0.45±0.05 (0.018±0.020)	6.5±0.5 (0.256±0.020)

Unit : mm(inch)

③テーピング寸法 Taping Dimensions

A-(a : 26mm幅)形状(a : 1.024 inch wide)configuration

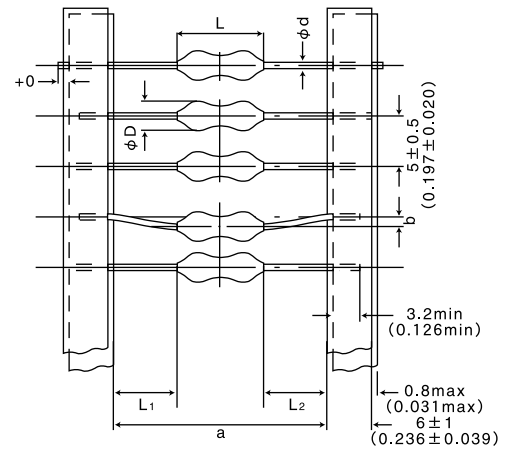

形式 Type	寸法 Dimensions						最小挿入 ピッチ Minimum insertion pitch
	φD	L	a	b	L ₁ -L ₂	φd	
積層形 Multilayer type	2.2 max (0.087max)	3.2 max (0.126max)	26 ^{+0.5} ₋₀	0.8以下	0.5max	0.45±0.05	5.0
単層形 Monolithic type	1.9 max (0.075max)	3.5 max (0.138max)	(1.024 ^{+0.020} ₀)	(0.031 or less)	(0.020max.)	(0.018±0.002)	(0.197)

Unit : mm(inch)

B-(a : 52mm幅)形状(a : 2.047 inches wide)configuration

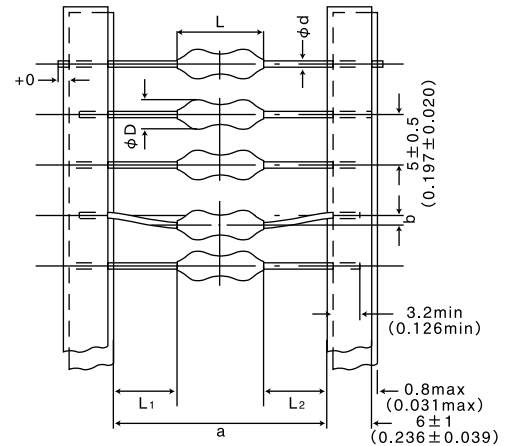

形式 Type	寸法 Dimensions						最小挿入 ピッチ Minimum insertion pitch
	φD	L	a	b	L ₁ -L ₂	φd	
積層形 Multilayer type	2.2 max (0.087max)	3.2 max (0.126max)	52 ⁺² ₋₁	1.2以下	1.0max	0.45±0.05	5.0
単層形 Monolithic type	1.9 max (0.075max)	3.5 max (0.138max)	(2.047 ^{+0.075} _{-0.035})	(0.047 or less)	(0.039max.)	(0.018±0.002)	(0.197)

Unit : mm(inch)

AXIAL LEADED CERAMIC CAPACITORS

Item	Specified Value					Test Methods and Remarks
	Temperature Compensating(Class 1)		High Permittivity(Class 2)		Semiconductor(Class 3)	
	Monolithic type	Multilayer Type	Monolithic type	Multilayer Type	Monolithic type	
1.Operating Temperature Range	-25 to +85°C	-55~+85°C	-25~+85°C	B: -25~+85°C (X5R: -55~+85°C) F: -25~+85°C (Y5V: -30~+85°C)	-25~+85°C	
2.Storage Temperature Range	-25 to +85°C					
3.Rated Voltage	50VDC		50VDC	16VDC,25VDC,50VDC	16VDC,25VDC,50VDC	
4.Withstanding Voltage	Between terminals	No abnormality				Applied voltage: Rated Voltage×3 (Class 1) (Class 2: Monolithic type) Rated Voltage×1.5 (Class 3: B) 18V (Class 3: X,Y) Rated Voltage×2 (Class 2: Multilayer type) (Class 3: F) Rated Voltage×2.5 (Class 2: Multilayer type 50VDC) Duration: 1 to 5 sec. Charge/discharge current: 50mA max. (Class 1,2) 10mA max. (Class 3)
	Between terminals and body	No abnormality				Metal globule method Applied voltage: Rated Voltage×2.5 Duration: 1 to 5 sec. Charge/Discharge current : 50mA max.
5.Insulation Resistance	10,000 MΩ min.		10,000 MΩ min.	Rated voltage: 16 VDC F: 250 MΩ min. Rated voltage: 25 VDC B: 1,000 MΩ min. Rated voltage: 50 VDC B(X5R) : 1200pF~3900pF : 5000MΩmin. 4700pF~10000pF : 1000MΩmin. F(Y5V) : 1000pF~10000pF : 1000MΩmin. 22000pF~47000pF : 500MΩmin. 100000pF : 250MΩmin.	1,000 MΩ min.	Applied voltage: Rated voltage Duration : 60±5 sec.
6.Capacitance	1.8 pF or under : ±20% 2.2 pF to 8.2 pF: ±10% 10 pF or over : ±5%	±5%	Rated voltage: 50 VDC B: 75 pF to 560 pF : ±10%	Rated voltage: 16 VDC F: 1,000,000 pF: $\frac{80}{20}$ % Rated voltage: 25 VDC B: 100,000 pF: ±10% Rated voltage: 50 VDC B(X5R): ±10% F(Y5V): $\frac{+80}{-20}$ %	Rated voltage: 16 VDC X: 1,200 pF to 6,800 pF: ±20%, ±30% Y: 8,200 pF, 10,000 pF : ±20%, ±30% Rated voltage: 25 VDC F: 10,000 pF, 22,000 pF : $\frac{+80}{-20}$ % Rated voltage: 50 VDC B: 680 pF to 1,000 pF: ±10%	Measuring frequency 1MHz±20% (Class 1: Monolithic type) 1kHz±20% (Class 2: Monolithic type) (Class 3) 1MHz±10% (Class 1: Multilayer type C≤1000pF) 1kHz±10% (Class 1: Multilayer type C>1000pF) 1kHz±10% (Class 2: Multilayer type) Measuring voltage:1.0±0.5Vrms (Class 1,2) (Class 3: B,X,Y) 0.1Vrms max. (Class 3: F) Measuring temperature: 20°C (Monolithic type) Bias application: None
7.Q or Tangent of Loss Angle	30 pF or under : Q≥400+20C 33 pF or over : Q≥500 16 pF to 18 pF of RH: Q≥500 C= Nominal capacitance [pF]	30 pF or under : Q≥400+20C 30 pF or over : Q≥1000	B: 75 pF to 390 pF: 1.5% max. 470 pF to 560 pF: 2.5% max	Rated voltage: 16 VDC F: 15.0% max. Rated voltage: 25 VDC B: 5.0% max. Rated voltage: 50 VDC B(X5R) : 1200pF~3900pF : 3.5% max. 4700pF~10000pF : 5.0% max. F(Y5V) : 1000pF~10000pF : 7.5% max. 22000pF~47000pF : 10.0% max. 100000pF : 15.0% max.	Rated voltage: 16 VDC X: 2.5% max. Y: 2.5% max. Rated voltage: 25 VDC F: 7.5% max. Rated voltage: 50 VDC B: 2.5% max.	
8.Capacitance Change due to Temperature or Rate of Capacitance Change	(When voltage is not applied)	CH: 0±60 RH: -220±60 UJ: -750±120 SL: +350 to -1,000 [ppm/C]	CH : 0±60 [ppm/C]	B: ±10% Rated voltage: 16 VDC F: $\frac{+30}{-85}$ % Rated voltage: 25 VDC B: ±10% Rated voltage: 50 VDC B: ±10% (X5R: ±15%) F: $\frac{+30}{-85}$ % (Y5V: $\frac{+22}{-82}$ %)	Rated voltage: 16 VDC X: ±15% Y: ±22% Rated voltage: 25 VDC F: $\frac{+30}{-85}$ % Rated voltage: 50 VDC B: ±10%	Measurement of capacitance at 20°C and 85°C, -25°C shall be made to calculate temperature characteristic by the following equation. (Class 1) $\frac{(C_{85} - C_{20})}{C_{20} \times \Delta T} \times 10^6$ (ppm/°C) F: $\frac{+30}{-85}$ % $\frac{(C_{-25} - C_{20})}{C_{20} \times \Delta T} \times 10^6$ (ppm/°C) Change of maximum capacitance deviation in step 1 to 5 (Class 2,3) Temperature at step 1: 20°C Temperature at step 4: 85°C Temperature at step 2: -25°C Temperature at step 5: 20°C Temperature at step 3: 20°C (Reference temperature) Reference temperature for X5R and Y5V shall be +25°C

Withstanding voltage is also referred to as "voltage proof" under IEC specifications.

AXIAL LEADED CERAMIC CAPACITORS

Item	Specified Value					Test Methods and Remarks							
	Temperature Compensating(Class 1)		High Permittivity(Class 2)		Semiconductor(Class 3)								
	Monolithic type	Multilayer Type	Monolithic type	Multilayer Type	Monolithic type								
9.Terminal Strength	Tensile	No abnormality such as cut lead, or looseness.					Apply the stated tensile force progressively in the direction to draw terminal. <table border="1"> <thead> <tr> <th>Nominal wire diameter [mm]</th> <th>Tensile force [N]</th> <th>Duration [s]</th> </tr> </thead> <tbody> <tr> <td>0.45</td> <td>19.6</td> <td>5</td> </tr> </tbody> </table>	Nominal wire diameter [mm]	Tensile force [N]	Duration [s]	0.45	19.6	5
	Nominal wire diameter [mm]	Tensile force [N]	Duration [s]										
0.45	19.6	5											
Torsional	No abnormalities, such as cuts or looseness of terminals.					Suspend a mass at the end the terminal, incline the body through angle of 90° and return it to initial position. This operation is done over a period of 5 sec. Then second bend in the opposite direction shall be made. Number of bends : 2 times <table border="1"> <thead> <tr> <th>Nominal wire diameter [mm]</th> <th>Bending force [N]</th> <th>Mass weight [kg]</th> </tr> </thead> <tbody> <tr> <td>0.45</td> <td>2.45</td> <td>0.25</td> </tr> </tbody> </table>	Nominal wire diameter [mm]	Bending force [N]	Mass weight [kg]	0.45	2.45	0.25	
Nominal wire diameter [mm]	Bending force [N]	Mass weight [kg]											
0.45	2.45	0.25											
10.Resistance to Vibration	Appearance: No significant abnormality Capacitance change: 1.8 pF or under : Within ±20% 2.2 pF to 8.2 pF: Within ±10% 10 pF or over : Within ± 5% Q : 30 pF or under : Q≥400+20C 33 pF or over : Q≥500 16 pF to 18 pF of RH: Q≥500 C= Nominal capacitance [pF] Insulation resistance: 10,000 MΩ min. Withstanding voltage: No abnormality	Appearance: No significant abnormality Capacitance change: Within ±5% Q : 30 pF or under : Q≥400+20C 30 pF or over : Q≥1000 Insulation resistance: 10,000 MΩ min. Withstanding voltage: No abnormality	Appearance: No significant abnormality Capacitance change: Within ±10% tan δ: 75 pF to 390 pF: 1.5% max. 470 pF to 560 pF: 2.5% max. Insulation resistance: 10,000 MΩ min. Withstanding voltage: No abnormality	Rated voltage: 16VDC Appearance: No significant abnormality Capacitance change: Within±80% tan δ: 15.0% max. Insulation resistance: 250 MΩmin. Withstanding voltage: No abnormality Rated voltage: 25 VDC, Appearance: No significant abnormality Capacitance change: Within ±10% tan δ: 5.0% max. Insulation resistance: 1,000 MΩ min. Withstanding voltage: No abnormality Rated voltage: 50 VDC Appearance: No significant abnormality B(X5R) Capacitance change: Within±10% tan δ : 1200pF~39000pF : 3.5%max. 47000pF~100000pF : 5.0%max. Insulation resistance: 1200pF~39000pF : 5000MΩmin. 47000pF~100000pF : 1000MΩmin. F(Y5V) Capacitance change: Within ±80% tan δ : 10000pF~100000pF: 7.5%max. 22000pF~47000pF: 10.0%max. 100000pF : 15.0%max. Insulation resistance: 10000pF~100000pF: 1000MΩmin. 22000pF~47000pF: 500MΩmin. 100000pF : 250MΩmin.	Rated voltage: 16 VDC Appearance: No significant abnormality Capacitance change : Within ±20%, Within ±30% tan δ: 2.5% max. Insulation resistance:1,000 MΩ min. Withstanding voltage: No abnormality Rated voltage: 25 VDC Appearance: No significant abnormality Capacitance change: Within ±80% tan δ: 7.5% max. Insulation resistance:1,000 MΩ min. Withstanding voltage: No abnormality Rated voltage: 50 VDC Appearance: No significant abnormality Capacitance change: Within ±10% tan δ: 2.5% max. Insulation resistance: 1,000 MΩ min. Withstanding voltage: No abnormality	According to JIS C 5102 clause 8.2 Vibration type: A Directions: 2 hrs each in X,Y and Z directions Total: 6 hrs Frequency range: 10 to 55 to 10Hz(1 min) Amplitude: 1.5 mm Mounting method: Soldering onto the PC board							
11.Free Fall	Appearance: No significant abnormality Capacitance change: 1.8 pF or under : Within ±20% 2.2 pF to 8.2 pF: Within ±10% 10 pF or over : Within ± 5% Q: 30 pF or under : Q≥400+20C 33 pF or over : Q≥500 16 pF to 18 pF of RH: Q≥500 C= Nominal capacitance [pF] Insulation resistance: 10,000 MΩ min. Withstanding voltage: No abnormality	Appearance: No significant abnormality Capacitance change: Within ±5% Q: 30 pF or under : Q≥400+20C 30 pF or over : Q≥1000 Insulation resistance: 10,000 MΩ min. Withstanding voltage: No abnormality	Rated voltage: 50 VDC Appearance: No significant abnormality Capacitance change: Within ±10% tan δ: 75 pF to 390 pF: 1.5% max. 470 pF to 560 pF: 2.5% max. Insulation resistance: 10,000 MΩ min. Withstanding voltage: No abnormality	Rated voltage: 16 VDC Appearance: No significant abnormality Capacitance change: Within±80% tan δ: 15.0% max. Insulation resistance: 250 MΩ min. Withstanding voltage: No abnormality Rated voltage: 25 VDC, Appearance: No significant abnormality Capacitance change: Within ±10% tan δ: 5.0% max. Insulation resistance: 1,000 MΩ min. Withstanding voltage: No abnormality Rated voltage: 50 VDC Appearance: No significant abnormality B(X5R) Capacitance change: Within±10% tan δ : 1200pF~39000pF : 3.5%max. 47000pF~100000pF : 5.0%max. Insulation resistance: 1200pF~39000pF : 5000MΩmin. 47000pF~100000pF : 1000MΩmin. F(Y5V) Capacitance change: Within ±80% tan δ : 10000pF~100000pF: 7.5%max. 22000pF~47000pF: 10.0%max. 100000pF : 15.0%max. Insulation resistance: 10000pF~100000pF: 1000MΩmin. 22000pF~47000pF: 500MΩmin. 100000pF : 250MΩmin.	Rated voltage: 16 VDC Appearance: No significant abnormality Capacitance change: Within ±20%, Within ±30% tan δ: 2.5% max. Insulation resistance: 1000 MΩ min. Withstanding voltage: No abnormality Rated voltage: 25 VDC Appearance: No significant abnormality Capacitance change: Within ±10% tan δ: 2.5% max. Insulation resistance: 1,000 MΩ min. Withstanding voltage: No abnormality	Drop Test: Free fall Impact material: Floor Height: 1 m Total number of drops: 5 times							

Withstanding voltage is also referred to as "voltage proof" under IEC specifications.

AXIAL LEADED CERAMIC CAPACITORS

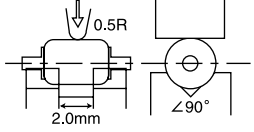
Item	Specified Value					Test Methods and Remarks																		
	Temperature Compensating(Class 1)		High Permittivity(Class 2)		Semiconductor (Class 3)																			
	Monolithic type	Multilayer Type	Monolithic type	Multilayer Type	Monolithic type																			
12.Body Strength	No abnormality such as damage					Applied force: 19.6N Duration: 5 sec. Speed: Shall attain to specified force in 2 sec. 																		
13.Solderability	At least 75% of lead surface is covered with new solder.					Solder temperature: 230±5°C Duration: 2±0.5 sec. (This test may be applicable after 6 months storage.)																		
14.Soldering	Appearance: No significant abnormality Capacitance change: 1.0 pF to 4.7pF : Within ±0.25 pF 5.6 pF or over : Within ±5% Q: 30 pF or under : Q≥400+20C 33 pF or over : Q≥500 16 pF to 18 pF of RH: Q≥500 C= Nominal capacitance [pF] Insulation resistance: 10,000 MΩ min. Withstanding voltage: No abnormality	Appearance: No significant abnormality Capacitance change: Within ±2.5% Q : 30 pF or under : Q≥400+20C 30 pF or over : Q≥1000 Insulation resistance: 10,000 MΩ min. Withstanding voltage: No abnormality	Rated voltage: 50 VDC Appearance: No significant abnormality Capacitance change: Within ±10% tan δ : 75 pF to 390 pF: 1.5% max. 470 pF to 560 pF: 2.5% max. Insulation resistance: 10,000 MΩ min. Withstanding voltage: No abnormality	Rated voltage: 16 VDC Appearance: No significant abnormality Capacitance change: Within ±20% tan δ : 15.0% max. Insulation resistance: 250 MΩ min. Withstanding voltage: No abnormality Rated voltage: 25 VDC, Appearance: No significant abnormality Capacitance change: Within ±10% tan δ : 5.0% max. Insulation resistance: 1,000 MΩ min. Withstanding voltage: No abnormality Rated voltage: 50 VDC Appearance: No significant abnormality B(X5R) Capacitance change: 1200pF~39000pF : Within 7.5% 47000pF~100000pF : Within 10.0% tan δ : 1200pF~39000pF : 3.5%max. 47000pF~100000pF : 5.0%max. Insulation resistance: 1200pF~39000pF : 5000MΩmin. 47000pF~100000pF : 1000MΩmin. F(Y5V) Capacitance change: 10000pF~100000pF: Within 20.0% tan δ : 10000pF~100000pF: 7.5%max. 220000pF~470000pF: 10.0%max. 1000000pF : 15.0%max. Insulation resistance: 1000pF~10000pF: 1000MΩmin. 220000pF~470000pF: 500MΩmin. 1000000pF : 250MΩmin. Withstanding voltage: No abnormality	Rated voltage: 16 VDC Appearance: No significant abnormality Capacitance change: Within ±10% tan δ : 2.5% max. Insulation resistance: 1,000 MΩ min. Withstanding voltage: No abnormality Rated voltage: 25 VDC Appearance: No significant abnormality Capacitance change: Within ±30% tan δ : 7.5% max. Insulation resistance: 1,000 MΩ min. Withstanding voltage: No abnormality Rated voltage: 50 VDC Appearance: No significant abnormality Capacitance change: Within ±10% tan δ : 2.5% max. Insulation resistance: 1,000 MΩ min. Withstanding voltage: No abnormality	(Class 1, Class 2: Monolithic type, Class 3) Solder temperature: 350±10°C Duration: 3 ^{+0.5} _{-1.0} sec. or Solder temperature: 260±5°C Duration: 10±1 sec. Immersed conditions: Inserted into the PC board (with t=1.6mm, hole=1.0mm diameter) Recovery: 4 to 24 hrs of recovery under the standard condition after the test. (Class 2: Multilayer type) Solder temperature: 270±5°C Duration: 5±0.5 sec. Immersed conditions: Inserted into the PC board (with t=1.6mm, hole=1.0mm diameter) Preconditioning: 1 hr of preconditioning at 150 ⁺⁰ ₋₁₀ °C followed by 48±4 hrs of recovery under the standard condition. Recovery: 48±4 hrs of recovery under the standard condition after the test.																		
15.Resistance to Solvent	No abnormality in appearance and legible marking.					According to JIS C 5102 clause 8.7.4. Type of test: Method 1 Solvent temperature: 20 to 25°C Duration: 30±5 sec. Solvent Type: A in Table 23, Isopropyl alcohol																		
16.Thermal Shock	Appearance: No significant abnormality Capacitance change: 1.0 pF to 10 pF : Within ±0.5pF 11 pF or over : Within ±5% Q : Under 10 pF : Q≥200+10C 10 pF to 30 pF: Q≥275+2.5C 33 pF or over: Q≥250 16 pF to 18 pF of RH: Q≥250 C= Nominal capacitance [pF] Insulation resistance: 1,000 MΩ min. Withstanding voltage: No abnormality	Appearance: No significant abnormality Capacitance change: Within ±5% Q : 30 pF or under : Q≥275+2.5C 30 pF or over : Q≥350 Insulation resistance: 1,000 MΩ min. Withstanding voltage: No abnormality	Rated voltage: 50 VDC Appearance: No significant abnormality Capacitance change: Within ±10% tan δ : 75 pF to 390 pF: 2.5% max. 470 pF to 560 pF: 4% max. Insulation resistance: 1,000 MΩ min. Withstanding voltage: No abnormality	Rated voltage: 16 VDC Appearance: No significant abnormality Capacitance change: Within ±30% tan δ : 17.5% max. Insulation resistance: 50 MΩ min. Withstanding voltage: No abnormality Rated voltage: 25 VDC, Appearance: No significant abnormality Capacitance change: Within ±15% tan δ : 7.5% max. Insulation resistance: 500 MΩ min. Withstanding voltage: No abnormality Rated voltage: 50 VDC Appearance: No significant abnormality B(X5R) Capacitance change: 1200pF~39000pF : Within 12.5% 47000pF~100000pF : Within 15.0% tan δ : 1200pF~39000pF : 5.0%max. 47000pF~100000pF : 7.5%max. Insulation resistance: 1200pF~39000pF : 1000MΩmin. 47000pF~100000pF: 500MΩmin. F(Y5V) Capacitance change: 10000pF~100000pF: Within 30.0% tan δ : 10000pF~100000pF: 12.5%max. 220000pF~470000pF: 15.0%max. 1000000pF : 17.5%max. Insulation resistance: 1000pF~10000pF: 500MΩmin. 220000pF~470000pF: 250MΩmin. 1000000pF : 50MΩmin. Withstanding voltage: No abnormality	Rated voltage: 16 VDC Appearance: No significant abnormality Capacitance change: Within ±10% tan δ : 4% max. Insulation resistance: 500 MΩ min. Withstanding voltage: No abnormality Rated voltage: 25 VDC Appearance: No significant abnormality Capacitance change: Within ±30% tan δ : 12.5% max. Insulation resistance: 500 MΩ min. Withstanding voltage: No abnormality Rated voltage: 50 VDC Appearance: No significant abnormality Capacitance change: Within ±10% tan δ : 4% max. Insulation resistance: 500 MΩ min. Withstanding voltage: No abnormality	Conditions for 1 cycle <table border="1"> <thead> <tr> <th>Step</th> <th>Temperature [°C]</th> <th>Duration [min]</th> </tr> </thead> <tbody> <tr> <td>1</td> <td>Room temperature</td> <td>Within 3</td> </tr> <tr> <td>2</td> <td>-25⁺⁰₋₃</td> <td>30±3</td> </tr> <tr> <td>3</td> <td>Room temperature</td> <td>Within 3</td> </tr> <tr> <td>4</td> <td>+85⁺³₋₀</td> <td>30±3</td> </tr> <tr> <td>5</td> <td>Room temperature</td> <td>Within 3</td> </tr> </tbody> </table> Number of cycles: 5 Preconditioning: 1 hr of preconditioning at 150 ⁺⁰ ₋₁₀ °C followed by 48±4 hrs of recovery under the standard condition. (Class 2: Multilayer type) Recovery: 1 hr of recovery under the standard condition after the removal from test chamber. (Monolithic type) 48±4 hrs of recovery under the standard condition after the removal from test chamber. (Class 2: Multilayer type)	Step	Temperature [°C]	Duration [min]	1	Room temperature	Within 3	2	-25 ⁺⁰ ₋₃	30±3	3	Room temperature	Within 3	4	+85 ⁺³ ₋₀	30±3	5	Room temperature	Within 3
Step	Temperature [°C]	Duration [min]																						
1	Room temperature	Within 3																						
2	-25 ⁺⁰ ₋₃	30±3																						
3	Room temperature	Within 3																						
4	+85 ⁺³ ₋₀	30±3																						
5	Room temperature	Within 3																						

Withstanding voltage is also referred to as "voltage proof" under IEC specifications.
 Thermal Shock is also referred to as "rapid change of temperature" under IEC specifications.

AXIAL LEADED CERAMIC CAPACITORS

Item	Specified Value					Test Methods and Remarks
	Temperature Compensating(Class 1)		High Permittivity(Class 2)		Semiconductor (Class 3)	
	Monolithic type	Multilayer Type	Monolithic type	Multilayer Type	Monolithic type	
17.Damp Heat (steady state)	Appearance: No significant abnormality Capacitance change: 1.0 pF to 10 pF : Within ±0.5pF 11 pF or over : Within ± 5% Q: Under 10 pF : Q≥200+10C 10 pF to 30 pF: Q≥275+2.5C 33 pF or over : Q≥250 16 pF to 18 pF of RH: Q≥250 C= Nominal capacitance [pF] Insulation resistance: 1,000 MΩ min. Withstanding voltage: No abnormality	Appearance: No significant abnormality Capacitance change: Within ±5% Q : 30 pF or under : Q≥275+2.5C 30 pF or over : Q≥350 Insulation resistance: 1,000 MΩ min. Withstanding voltage: No abnormality	Rated voltage: 50 VDC Appearance: No significant abnormality Capacitance change: Within ±10% tan δ: 75 pF to 390 pF: 2.5% max. 470 pF to 560 pF: 4% max. Insulation resistance: 1,000 MΩ min. Withstanding voltage: No abnormality	Rated voltage: 16 VDC Appearance: No significant abnormality Capacitance change: Within ±30% tan δ: 17.5% max. Insulation resistance: 50 MΩ min. Withstanding voltage: No abnormality Rated voltage: 25 VDC, Rated voltage: 50 VDC Appearance: No significant abnormality B(X5R) Capacitance change: 1200pF~3900pF : Within 12.5% 47000pF~100000pF : Within 15.0% tan δ : 1200pF~3900pF : 5.0%/max. 4700pF~10000pF : 7.5%/max. Insulation resistance: 1200pF~3900pF : 1000MΩmin. 47000pF~100000pF: 500MΩmin. F(Y5V) Capacitance change: 10000pF~100000pF: Within 30.0% tan δ : 10000pF~100000pF: 12.5%/max. 22000pF~47000pF: 15.0%/max. 100000pF : 17.5%/max. Insulation resistance: 10000pF~100000pF: 500MΩmin. 22000pF~47000pF: 250MΩmin. 100000pF : 50MΩmin. Withstanding voltage: No abnormality	Rated voltage: 16 VDC Appearance: No significant abnormality Capacitance change: Within ±10% tan δ: 4% max. Insulation resistance: 500 MΩ min. Withstanding voltage: No abnormality Rated voltage: 25 VDC Appearance: No significant abnormality Capacitance change: Within ±30% tan δ: 12.5% max. Insulation resistance: 500 MΩ min. Withstanding voltage: No abnormality Rated voltage: 50 VDC Appearance: No significant abnormality Capacitance change: Within ±10% tan δ: 4% max. Insulation resistance: 500 MΩ min. Withstanding voltage: No abnormality	Temperature: 40±2°C Humidity: 90 to 95 % RH Duration: 500 ⁺²⁴ ₀ hrs Preconditioning: 1 hr of preconditioning at 150 ⁺⁹ ₁₀ °C followed by 48±4 hrs of recovery under the standard condition. (Class 2: Multilayer type) Recovery: 1 hr of recovery under the standard condition after the removal from test chamber. (Monolithic type) 24±2 hrs of recovery under the standard condition after the removal from test chamber. (Class 1: Multilayer type) 48±4 hrs of recovery under the standard condition after the removal from test chamber. (Class 2: Multilayer type)
18.Loading under Damp Heat	Appearance: No significant abnormality Capacitance change: 1.0 pF to 10 pF : Within ±0.75pF 11 pF or over : Within ±7.5% Q: 30 pF or under: Q≥100+ ¹⁰ / ₃ C 33 pF or over : Q≥125 16 pF to 18 pF of RH: Q≥125 C= Nominal capacitance [pF] Insulation resistance: 500 MΩ min. Withstanding voltage: No abnormality	Appearance: No significant abnormality Capacitance change: Within ±7.5% Q : 30 pF or under : Q≥100+10/3 · C 30 pF or over : Q≥200 Insulation resistance: 500 MΩ min. Withstanding voltage: No abnormality	Rated voltage: 50 VDC Appearance: No significant abnormality Capacitance change: Within ±10% tan δ: 75 pF to 390 pF: 2.5% max. 470 pF to 560 pF: 5% max. Insulation resistance: 500 MΩ min. Withstanding voltage: No abnormality	Rated voltage: 16 VDC Appearance: No significant abnormality Capacitance change: Within ±30% tan δ: 17.5% max. Insulation resistance: 25 MΩ min. Withstanding voltage: No abnormality Rated voltage: 25 VDC, Rated voltage: 50 VDC Appearance: No significant abnormality B(X5R) Capacitance change: 1200pF~3900pF : Within 12.5% 47000pF~100000pF : Within 15.0% tan δ : 1200pF~3900pF : 5.0%/max. 4700pF~10000pF : 7.5%/max. Insulation resistance: 1200pF~3900pF : 500MΩmin. 47000pF~100000pF: 250MΩmin. F(Y5V) Capacitance change: 10000pF~100000pF: Within 30.0% tan δ : 10000pF~100000pF: 12.5%/max. 22000pF~47000pF: 15.0%/max. 100000pF : 17.5%/max. Insulation resistance: 10000pF~100000pF : 250MΩmin. 22000pF~47000pF : 125MΩmin. 100000pF : 25MΩmin. Withstanding voltage: No abnormality	Rated voltage: 16 VDC Appearance: No significant abnormality Capacitance change: Within ±10% tan δ: 5% max. Insulation resistance: 250 MΩ min. Withstanding voltage: No abnormality Rated voltage: 25 VDC Appearance: No significant abnormality Capacitance change: Within ±30% tan δ: 12.5% max. Insulation resistance: 250 MΩ min. Withstanding voltage: No abnormality Rated voltage: 50 VDC Appearance: No significant abnormality Capacitance change: Within ±10% tan δ: 5% max. Insulation resistance: 250 MΩ min. Withstanding voltage: No abnormality	Temperature: 40±2°C Humidity: 90 to 95 % RH Duration: 500 ⁺²⁴ ₀ hrs Applied voltage: Rated voltage Preconditioning: Voltage treatment (Class 2: Multilayer type) Recovery: 1 hr of recovery under the standard condition after the removal from test chamber. (Class 1, Class 2: Monolithic type) 24±2 hrs of recovery under the standard condition after the removal from test chamber. (Class 1: Multilayer type) 48±4 hrs of recovery under the standard condition after the removal from test chamber. (Class 2: Multilayer type) 30 min. of conditioning at 150±3°C followed by 1 hr of recovery under the standard condition after the removal from test chamber. (Class 3)

Withstanding voltage is also referred to as "voltage proof" under IEC specifications.

AXIAL LEADED CERAMIC CAPACITORS

Item	Specified Value					Test Methods and Remarks
	Temperature Compensating(Class 1)		High Permittivity(Class 2)		Semiconductor (Class 3)	
	Monolithic type	Multilayer Type	Monolithic type	Multilayer Type	Monolithic type	
19. High Temperature Loading Test	Appearance: No significant abnormality Capacitance change: 1.0 pF to 10 pF : Within ±0.3pF 11 pF or over : Within ± 3% Q: Under 10 pF : Q≥200+10C 10 pF to 30 pF : Q≥275+2.5C 33 pF or over : Q≥250 16 pF to 18 pF of RH: Q≥250 C= Nominal capacitance [pF] Insulation resistance: 1,000 MΩ min. Withstanding voltage: No abnormality	Appearance: No significant abnormality Capacitance change: Within ± 3% Q : 30 pF or under : Q≥275+2.5C 30 pF or over : Q≥350 Insulation resistance: 1,000 MΩ min. Withstanding voltage: No abnormality	Rated voltage: 50 VDC Appearance: No significant abnormality Capacitance change: Within ±10% tan δ : 75 pF to 390 pF: 2.5% max. 470 pF to 560 pF: 4% max. Insulation resistance: 1,000 MΩ min. Withstanding voltage: No abnormality	Rated voltage: 16 VDC Appearance: No significant abnormality Capacitance change: Within ±30% tan δ : 17.5% max. Insulation resistance: 50 MΩ min. Withstanding voltage: No abnormality Rated voltage: 25 VDC, Rated voltage: 50 VDC Appearance: No significant abnormality B(X5R) Capacitance change: 1200pF~39000pF : Within 12.5% 47000pF~100000pF : Within 15.0% tan δ : 1200pF~39000pF : 5.0%/max. 47000pF~100000pF : 7.5%/max. Insulation resistance: 1200pF~39000pF : 1000MΩmin. 47000pF~100000pF: 500MΩmin. F(Y5V) Capacitance change: 10000pF~100000pF: Within30.0% tan δ : 10000pF~100000pF: 10.0%/max. 220000pF~470000pF: 12.5%/max. 1000000pF : 17.5%/max. Insulation resistance: 10000pF~100000pF: 500MΩmin. 220000pF~470000pF: 250MΩmin. 1000000pF : 50MΩmin. Withstanding voltage: No abnormality	Rated voltage: 16 VDC Appearance: No significant abnormality Capacitance change: Within ±10% tan δ : 4% max. Insulation resistance: 500MΩ min. Withstanding voltage: No abnormality Rated voltage: 25 VDC Appearance: No significant abnormality Capacitance change: Within ±30% tan δ : 10% max. Insulation resistance: 500MΩ min. Withstanding voltage: No abnormality Rated voltage: 50 VDC Appearance: No significant abnormality Capacitance change: Within ±10% tan δ : 4% max. Insulation resistance: 500 MΩ min. Withstanding voltage: No abnormality	Temperature: 85 ± ₃ ⁰ °C Duration: 1000 ⁺⁴⁸ ₋₀ hrs Applied voltage: Rated voltage×2 (Class 1) (Class 2) Rated voltage×1.5 (Class 3: B, F) Rated voltage×1.125 (Class 3: X, Y) Preconditioning: Voltage treatment (Class 2: Multilayer type) Recovery: 1 hr of recovery under the standard condition after the removal from test chamber. (Class 1, Class 2: Monolithic type) 24±2hrs of recovery under the standard condition after the removal from test chamber. (Class1:Multilayer type) 48±4 hrs of recovery under the standard condition after the removal from test chamber. (Class 2: Multilayer type) As for Class2:Multilayer type B:47000pF~100000pF F:220000pF~1000000pF 1hr of conditioning at 150 ⁺⁰ ₋₁₀ °C followed by 48±4 Hr of recovery under the standard condition after the removal from test chamber. 30 min. of conditioning at 150±3°C followed by 1 hr of recovery under the standard condition after the removal from test chamber. (Class 3)

Note on standard condition: "standard condition" referred to herein is defined as follows: 5 to 35°C of temperature, 45 to 85% relative humidity, and 86 to 106kPa of air pressure.

When there are questions concerning measurement results:

In order to provide correlation data, the test shall be conducted under condition of 20±2°C of temperature, 60 to 70% relative humidity, and 86 to 106kPa of air pressure. Unless otherwise specified, all the tests are conducted under the "standard condition."

Withstanding voltage is also referred to as "voltage proof" under IEC specifications.

Precautions on the use of Axial Leaded Ceramic Capacitors

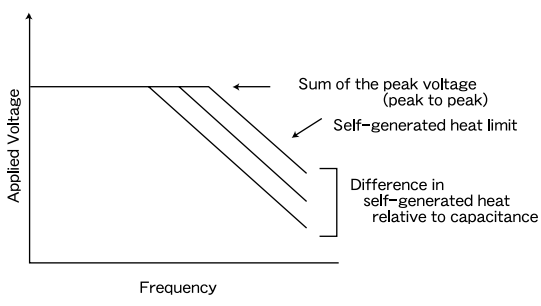
Stages	Precautions	Technical considerations
<p>1. Circuit Design</p>	<p>◆Verification of operating environment, electrical rating and performance</p> <p>1. A malfunction in medical equipment, spacecraft, nuclear reactors, etc. may cause serious harm to human life or have severe social ramifications. As such, any capacitors to be used in such equipment may require higher safety and/or reliability considerations and should be clearly differentiated from components used in general purpose applications.</p> <p>◆Verification of Rated voltage (DC rated voltage)</p> <p>1. The operating voltage for capacitors must always be lower than their rated values.</p> <p>If an AC voltage is loaded on a DC voltage, the sum of the two peak voltages should be lower than the rated value of the capacitor chosen. For a circuit where both an AC and a pulse voltage may be present, the sum of their peak voltages should also be lower than the capacitor's rated voltage.</p> <p>2. Even if the applied voltage is lower than the rated value, the reliability of capacitors might be reduced if either a high frequency AC voltage or a pulse voltage having rapid rise time is present in the circuit.</p> <p>◆Self-generated heat (Verification of Temperature)</p> <p>1. If the capacitors specified only for DC use are used in AC or pulse circuits, the AC or a pulse current can generate heat inside the capacitor so the self-generated temperature rise should be limited to within 20°C. The surface temperature measured should include this self-temperature rise. Therefore, it is required to limit capacitor surface temperature including self-generated heat should not exceed the maximum operating temperature of +85°C.</p> <p>◆Operating Environment precautions</p> <p>1. Capacitors should not be used in the following environments:</p> <p>(1)Environmental conditions to avoid</p> <p>a. exposure to water or salt water.</p> <p>b. exposure to moisture or condensation.</p> <p>c. exposure to corrosive gases (such as hydrogen sulfide, sulfuric acid, chlorine, and ammonia)</p>	<p>1-1. When an AC or a pulse voltage is applied to capacitors specified for DC use, even if the voltage is less than the rated voltage, the AC current or pulse current running through the capacitor will cause the capacitor to self-generate heat because of the loss characteristics.</p> <p>The amount of heat generated depends on the dielectric materials used, capacitance, applied voltage, frequency, voltage waveform, etc. The surface temperature changes due to emitted heat which differs by capacitor shape or mounting method.</p> <p>Please contact Taiyo Yuden with any questions regarding emitted heat levels in your particular application. It is recommended the temperature rise be measured in the actual circuit to be used.</p> <p>1-2. For capacitors, the voltage and frequency relationship is generally determined by peak voltage at low frequencies, and by self-generated heat at high frequencies. (Refer to the following curve.)</p> 
<p>2. PCB Design</p>	<p>1. When capacitors are mounted onto a PC board, hole dimensions on the board should match the lead pitch of the component, if not it will cause breakage of the terminals or cracking of terminal roots covered with resin as excess stress travels through the terminal legs. As a result, humidity resistance performance would be lost and may lead to a reduction in insulation resistance and cause a withstand voltage failure.</p>	
<p>3. Considerations for automatic insertion</p>	<p>◆Adjustment Automatic Insertion machines (leaded components)</p> <p>1. When inserting capacitors in a PC board by auto-insertion machines the impact load imposed on the capacitors should be minimized to prevent the leads from chocking or clinching.</p>	

Precautions on the use of Axial Leaded Ceramic Capacitors

Stages	Precautions	Technical considerations
4. Soldering	<p>◆Selection of Flux</p> <ol style="list-style-type: none"> When soldering capacitors on the board, flux should be applied thinly and evenly. Flux used should be with less than or equal to 0.1 wt% (equivalent to Chlorine) of halogenated content. Flux having a strong acidity content should not be applied. When using water-soluble flux, special care should be taken to properly clean the boards. <p>◆Wave Soldering</p> <ol style="list-style-type: none"> Temperature, time, amount of solder, etc. are specified in accordance with the following recommended conditions. Do not immerse the entire capacitor in the flux during the soldering operation. Only solder the lead wires on the bottom of the board. 	<ol style="list-style-type: none"> Flux is used to increase solderability in wave soldering, but if too much is applied, a large amount of flux gas may be emitted and may detrimentally affect solderability. To minimize the amount of flux applied, it is recommended to use a flux-bubbling system. With too much halogenated substance (Chlorine, etc.) content is used to activate the flux, an excessive amount of residue after soldering may lead to corrosion of the terminal electrodes or degradation of insulation resistance on the surface of the capacitors. Since the residue of water-soluble flux is easily dissolved by water content in the air, the residue on the surface of capacitors in high humidity conditions may cause a degradation of insulation resistance and therefore affect the reliability of the components. The cleaning methods and the capability of the machines used should also be considered carefully when selecting water-soluble flux. <ol style="list-style-type: none"> If capacitors are used beyond the range of the recommended conditions, heat stresses may cause cracks inside the capacitors, and consequently degrade the reliability of the capacitors. When the capacitors are dipped in solder, some soldered parts of the capacitor may melt due to solder heat and cause short-circuits or cracking of the ceramic material. Deterioration of the resin coating may lower insulation resistance and cause a reduction of withstand voltage.
5. Cleaning	<p>◆Board cleaning</p> <ol style="list-style-type: none"> When cleaning the mounted PC boards, make sure that cleaning conditions are consistent with prescribed usage conditions. 	<ol style="list-style-type: none"> The resin material used for the outer coating of capacitors is occasionally a wax substance for moisture resistance which can easily be dissolved by some solutions. So before cleaning, special care should be taken to test the component's vulnerability to the solutions used. When using water-soluble flux please clean the PCB with purified water sufficiently and dry thoroughly at the end of the process. Insufficient washing or drying could lower the reliability of the capacitors.
6. Post-cleaning-process	<p>◆Application of resin molding, etc. to the PCB and components.</p> <ol style="list-style-type: none"> Please contact your local Taiyo Yuden sales office before performing resin coating or molding on mounted capacitors. Please verify on the actual application that the coating process will not adversely affect the component quality. 	<ol style="list-style-type: none"> 1-1. The thermal expansion and coefficient of contraction of the molded resin are not necessarily matched with those of the capacitor. The capacitors may be exposed to stresses due to thermal expansion and contraction during and after hardening. This may lower the specified characteristics and insulation resistance or cause reduced withstand voltage by cracking the ceramic or separating the coated resin from the ceramics. 1-2. With some types of mold resins, the resin's decomposition gas or reaction gas may remain inside the resin during the hardening period or while left under normal conditions, causing a deterioration of the capacitor's performance. 1-3. Some mold resins may have poor moisture proofing properties. Please verify the contents of the resins before they are applied. 1-4. Please contact Taiyo Yuden before using if the hardening process temperature of the mold resins is higher than the operating temperature of the capacitors.
7. Handling	<p>◆Mechanical considerations</p> <ol style="list-style-type: none"> Be careful not to subject the capacitors to excessive mechanical shocks. Withstanding voltage failure may result. If ceramic capacitors are dropped onto the floor or a hard surface they should not be used. 	<ol style="list-style-type: none"> Because the capacitor is made of ceramic, mechanical shocks applied to the board may damage or crack the capacitors. Ceramic capacitors which are dropped onto the floor or a hard surface may develop defects and have a higher risk of failure over time.
8. Storage conditions	<p>◆Storage</p> <ol style="list-style-type: none"> To maintain the solderability of terminal electrodes and to keep the packaging material in good condition, care must be taken to control temperature and humidity in the storage area. Humidity should especially be kept as low as possible. Recommended conditions: Ambient temperature Below 40 °C Humidity Below 70% RH. Products should be used within 6 months after delivery. After the above period, the solderability should be checked before using the capacitors. Capacitors should not be kept in an environment filled with decomposition gases such as (sulfurous hydrogen, sulfurous acid, chlorine, ammonia, etc.) Capacitors should not be kept in a location where they may be exposed to moisture, condensation or direct sunlight. 	<ol style="list-style-type: none"> Under high temperature/high humidity conditions, the decrease in solderability due to the oxidation of terminal electrodes and deterioration of taping and packaging characteristics may be accelerated.

USコンデンサ US CAPACITORS

OPERATING TEMP. -25~+85°C



特長 FEATURES

形状は106形および146形があり、106形には外装絶縁形もラインアップ

• Available in two shapes:106 and 146.
insulated type is available in the 106 type.

用途 APPLICATIONS

IFT内蔵用

• For applications requiring a IFT built-in type capacitor.

形名表記法 ORDERING CODE

1	2	3	4	5	6	7
定格電圧 (VDC)	形式・包装	形状 (mm)	温度特性 (ppm/°C)	公称静電容量 (pF)	容量許容差	当社管理記号
U 50	CA 単品 (袋詰め) - 絶縁形 S△ 単品 (袋詰め) - 非絶縁形 SH 梯子形 - 非絶縁形 △=スペース	106 7mm 角用 146 5mm 角用	CH 0±60 LH -80±60 PH -150±60 RH -220±60 SH -330±60 TH -470±60 UJ -750±120 UK -750±250	例 100 10 221 220	D ± 0.5 pF J ± 5 % K ± 10 % M ± 20 %	△△△△ 標準品 △=スペース



1	2	3	4	5	6	7
Rated voltage (VDC)	Type	External dimensions (inch)	Temperature characteristics (ppm/°C)	Nominal capacitance (pF)	Capacitance tolerance	Internal code
U 50	CA Single unit:insulated S△ Single unit:non-insulated SH Ladder type:non-insulated △=Blank Space	106 7mm square 146 5mm square	CH 0±60 LH -80±60 PH -150±60 RH -220±60 SH -330±60 TH -470±60 UJ -750±120 UK -750±250	example 100 10 221 220	D ± 0.5 pF J ± 5 % K ± 10 % M ± 20 %	△△△△ Standard Product △=Blank Space

インピーダンス—周波数特性例 Impedance-Frequency characteristics

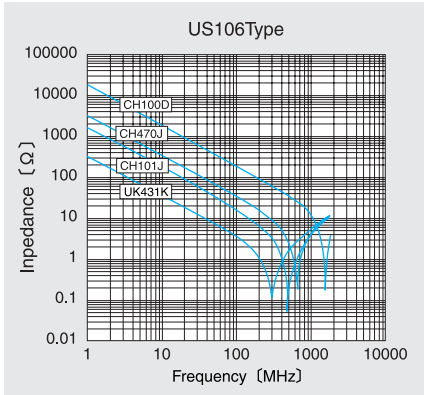

①標準数量 (Standard quantity)

■袋づめ/はしご形リール Bulk/Reel

形式 Type	標準数量(pcs.)	
	袋づめ Bulk	はしごリール Reel
□S 106	1000	—
□S 146		
□SH106	—	10000
□SH146		
□CA106	1000	—

②リール寸法 Reel Size

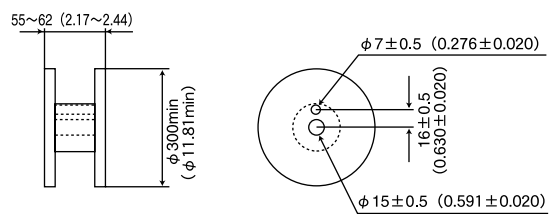

Unit : mm(inch)

Precautions on the use of US Capacitors

Stages	Precautions	Technical considerations
<p>1. Circuit Design</p>	<p>◆Verification of operating environment, electrical rating and performance</p> <p>1. A malfunction in medical equipment, spacecraft, nuclear reactors, etc. may cause serious harm to human life or have severe social ramifications. As such, any capacitors to be used in such equipment may require higher safety and/or reliability considerations and should be clearly differentiated from components used in general purpose applications.</p> <p>◆Verification of Rated voltage (DC rated voltage)</p> <p>1. The operating voltage for capacitors must always be lower than their rated values.</p> <p>If an AC voltage is loaded on a DC voltage, the sum of the two peak voltages should be lower than the rated value of the capacitor chosen. For a circuit where both an AC and a pulse voltage may be present, the sum of their peak voltages should also be lower than the capacitor's rated voltage.</p> <p>2. Even if the applied voltage is lower than the rated value, the reliability of capacitors might be reduced if either a high frequency AC voltage or a pulse voltage having rapid rise time is present in the circuit.</p> <p>◆Operating Environment precautions</p> <p>1. Capacitors should not be used in the following environments:</p> <p>(1)Environmental conditions to avoid</p> <p>a. exposure to water or salt water.</p> <p>b. exposure to moisture or condensation.</p> <p>c. exposure to corrosive gases (such as hydrogen sulfide, sulfuric acid, chlorine, and ammonia)</p>	<p>1-1. When an AC or a pulse voltage is applied to capacitors specified for DC use, even if the voltage is less than the rated voltage, the AC current or pulse current running through the capacitor will cause the capacitor to self-generate heat because of the loss characteristics.</p> <p>The amount of heat generated depends on the dielectric materials used, capacitance, applied voltage, frequency, voltage waveform, etc. The surface temperature changes due to emitted heat which differs by capacitor shape or mounting method.</p> <p>Please contact Taiyo Yuden with any questions regarding emitted heat levels in your particular application. It is recommended the temperature rise be measured in the actual circuit to be used.</p>
<p>2. PCB Design</p>	<p>1. When capacitors are mounted onto a PC board, hole dimensions on the board should match the lead pitch of the component, if not it will cause breakage of the terminals or cracking of the component as excess stress travels through the terminal legs. As a result, humidity resistance performance would be lost and may lead to a reduction in insulation resistance and cause a withstand voltage failure.</p>	
<p>3. Considerations for automatic insertion</p>	<p>◆Adjustment Automatic Insertion machines (leaded components)</p> <p>1. When inserting capacitors in a PC board by auto-insertion machines the impact load imposed on the capacitors should be minimized to prevent the leads from chocking or clinching.</p>	
<p>4. Soldering</p>	<p>◆Selection of Flux</p> <p>1. When soldering capacitors on the board, flux should be applied thinly and evenly.</p> <p>2. Flux used should be with less than or equal to 0.1 wt% (equivalent to Chlorine) of halogenated content. Flux having a strong acidity content should not be applied.</p> <p>3. When using water-soluble flux, special care should be taken to properly clean the boards.</p> <p>◆Wave Soldering</p> <p>1. Temperature, time, amount of solder, etc. are specified in accordance with the following recommended conditions.</p>	<p>1. Flux is used to increase solderability in wave soldering, but if too much is applied, a large amount of flux gas may be emitted and may detrimentally affect solderability. To minimize the amount of flux applied, it is recommended to use a flux-bubbling system.</p> <p>2. With too much halogenated substance (Chlorine, etc.) content is used to activate the flux, an excessive amount of residue after soldering may lead to corrosion of the terminal electrodes or degradation of insulation resistance on the surface of the capacitors.</p> <p>3. Since the residue of water-soluble flux is easily dissolved by water content in the air, the residue on the surface of capacitors in high humidity conditions may cause a degradation of insulation resistance and therefore affect the reliability of the components. The cleaning methods and the capability of the machines used should also be considered carefully when selecting water-soluble flux.</p> <p>1. If capacitors are used beyond the range of the recommended conditions, heat stresses may cause cracks inside the capacitors, and consequently degrade the reliability of the capacitors.</p>

Precautions on the use of US Capacitors

Stages	Precautions	Technical considerations
5. Cleaning	<p>◆Board cleaning</p> <p>1. When cleaning the mounted PC boards, make sure that cleaning conditions are consistent with prescribed usage conditions.</p>	<p>1. The resin material used for the outer coating of capacitors is occasionally a wax substance for moisture resistance which can easily be dissolved by some solutions. So before cleaning, special care should be taken to test the component's vulnerability to the solutions used.</p> <p>When using water-soluble flux please clean the PCB with purified water sufficiently and dry thoroughly at the end of the process. Insufficient washing or drying could lower the reliability of the capacitors.</p>
6. Post-cleaning-process	<p>◆Application of resin molding, etc. to the PCB and components.</p> <p>1. Please contact your local Taiyo Yuden sales office before performing resin coating or molding on mounted capacitors. Please verify on the actual application that the coating process will not adversely affect the component quality.</p>	<p>1-1. The thermal expansion and coefficient of contraction of the molded resin are not necessarily matched with those of the capacitor. The capacitors may be exposed to stresses due to thermal expansion and contraction during and after hardening. This may lower the specified characteristics and insulation resistance or cause reduced withstand voltage by cracking the ceramic or separating the coated resin from the ceramics.</p> <p>1-2. With some types of mold resins, the resin's decomposition gas or reaction gas may remain inside the resin during the hardening period or while left under normal conditions, causing a deterioration of the capacitor's performance.</p> <p>1-3. Some mold resins may have poor moisture proofing properties. Please verify the contents of the resins before they are applied.</p> <p>1-4. Please contact Taiyo Yuden before using if the hardening process temperature of the mold resins is higher than the operating temperature of the capacitors.</p>
7. Handling	<p>◆Mechanical considerations</p> <p>1. Be careful not to subject the capacitors to excessive mechanical shocks. Withstanding voltage failure may result.</p> <p>2. If ceramic capacitors are dropped onto the floor or a hard surface they should not be used.</p>	<p>1. Because the capacitor is made of ceramic, mechanical shocks applied to the board may damage or crack the capacitors.</p> <p>2. Ceramic capacitors which are dropped onto the floor or a hard surface may develop defects and have a higher risk of failure over time.</p>
8. Storage conditions	<p>◆Storage</p> <p>1. To maintain the solderability of terminal electrodes and to keep the packaging material in good condition, care must be taken to control temperature and humidity in the storage area. Humidity should especially be kept as low as possible. Recommended conditions: Ambient temperature Below 40 °C Humidity Below 70% RH. Products should be used within 6 months after delivery. After the above period, the solderability should be checked before using the capacitors.</p> <p>2. Capacitors should not be kept in an environment filled with decomposition gases such as (sulfurous hydrogen, sulfurous acid, chlorine, ammonia, etc.)</p> <p>3. Capacitors should not be kept in a location where they may be exposed to moisture, condensation or direct sunlight.</p>	<p>1. Under high temperature/high humidity conditions, the decrease in solderability due to the oxidation of terminal electrodes and deterioration of taping and packaging characteristics may be accelerated.</p>

貫通セラミックコンデンサ(段付形) FEEDTHROUGH CERAMIC CAPACITORS (STEPPED TYPE)

OPERATING TEMP. -25~+85°C



特長 FEATURES

- ・電極がニッケルのため半田くわれやマイグレーションの心配がなく量産性に優れる
- ・Nickel plated electrodes reduce the possibility of corrosion, migration and improve productivity.

用途 APPLICATIONS

- ・チューナ・通信機等の妨害対策として最適・高周波領域におけるノイズ吸収性が優れ、光ディスク関連など各種デジタル機器のEMC対策として有効
- ・Used as an interference countermeasure in tuners and telecommunication equipment
- ・Excellent as a EMC countermeasure in various types of digital equipment due to their noise absorption features in high frequency applications.

形名表記法 ORDERING CODE

G series

1	2	3	4	5
定格電圧 (VDC)	形状	温度特性	公称静電容量 (pF)	容量許容差
U 50	G3 φ2.8 mm 段付形 G1 φ1.85mm 段付形	△Y ± 22% SL +350~-1000ppm/°C △=スペース	例 020 2 102 1,000	D ± 0.5 pF K ± 10 % M ± 20 % V ± $\frac{20}{10}$ % P ± $\frac{100}{0}$ % Z ± 20 %
6	7			
芯線寸法	当社管理記号			
0607 A寸 6.0mm・B寸 7.0mm } } 1714 A寸 17.0mm・B寸 14.0mm	---A 標準品			

U | G | 3 | S | L | 0 | 2 | 0 | D | 0 | 6 | 0 | 7 | ○ | ○ | ○ | ○

1 | 2 | 3 | 4 | 5 | 6 | 7

1	2	3	4	5
Rated voltage[VDC]	Shape	Temperature characteristics	Nominal capacitance[pF]	Capacitance Tolerances
U 50	G3 φ2.8mm G1 φ1.85mm	△Y ± 22% S L +350~-1000ppm/°C △=Blank space	020 2 102 1,000	D ± 0.5 pF K ± 10 % M ± 20 % V ± $\frac{20}{10}$ % P ± $\frac{100}{0}$ % Z ± $\frac{80}{20}$ %
6	7			
Lead Length	Internal code			
0607 A 6.0mm・B 7.0mm } } 1714 A 17.0mm・B 14.0mm	---A Standard product			

		Gシリーズ Series G	
		リード付 Leaded type	
Fig.			
		G1	G3
Dimensions	D1	1.85 ^{+0.1} _{-0.15} (0.073)	2.8±0.2 (0.110±0.008)
	D2	1.4±0.1 (0.055±0.004)	2.0±0.1 (0.079±0.004)
	d	0.6±0.05 (0.024±0.002)	0.6±0.05 (0.024±0.002)
	L	1.4±0.1 (0.055±0.004)	2.0±0.5 (0.079±0.020)
	ℓ	0.5(参考値) (0.020) (reference)	0.7(参考値) (0.028) (reference)
	A	6.0~17.0(1mmステップ) (0.236~0.669)(0.039 Step)	
	B	7.0~14.0(1mmステップ) (0.276~0.551)(0.039 Step)	

Unit : mm(inch)

バリエーション AVAILABLE CAPACITANCE RANGE

G series

形名 Type	温度特性 Temperature characteristics	公称静電容量 Capacitance [pF]	Q or tan δ	容量許容差 Capacitance tolerance	定格電圧 Rated voltage (DC)	耐電圧 withstanding voltage (DC)	
G1	SL	2	Q≥50	± 0.5pF	50V	150V	
		10	Q≥100	± 20%			
		33 43 82	Q≥100	± 10%			
G3	SL	1000	tan δ ≤ 5.0%	± 20%		50V	100V
		1 2	Q≥50	± 0.5pF			
		10 22 33 43	Q≥100	± 10%			
Y(Y5S)	Y(Y5S)	82	tan δ ≤ 5.0%	± 20%	50V		150V
		1000	tan δ ≤ 5.0%	± 100%			
		2000	tan δ ≤ 5.0%	± 80%			

(注)温度特性の()はEIA規格相当表示です。

() Indicates EIA standard.

セレクションガイド
Selection Guide



etc

アイテム一覧
Part Numbers



特性図
Electrical Characteristics



梱包
Packaging



信頼性
Reliability Data



使用上の注意
Precautions



特性図 ELECTRICAL CHARACTERISTICS

インピーダンス—周波数特性例 Impedance - vs - Frequency characteristics

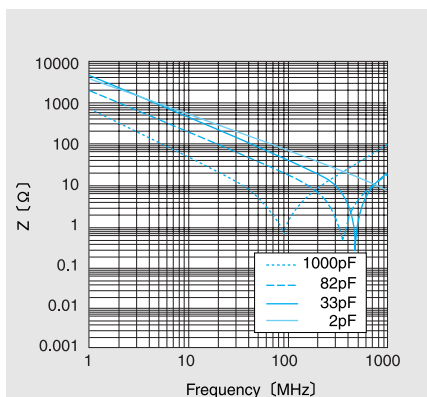

梱包 PACKAGING

標準数量 Standard quantity

区分 Category	形式 Type	標準数量(pcs) 袋詰め Bulk
段付 Stepped type	UG1 UG3	1000

FEEDTHROUGH CERAMIC CAPACITORS (STEPPED TYPE)

No.	Item	Specified Value		Test Methods and Remarks
		Stepped feed-through capacitor		
		series G		
		(Class 1)	(Class 3)	
1.	Operating Temperature Range	-25 to +85°C		
2.	Storage Temperature Range	-25 to +85°C		
3.	Rated Voltage	50 VDC		
4.	Withstanding Voltage	Between terminals	No abnormality	According to JIS C 5102 clause 7.1.3. Applied voltage: 125V DC (Class 1) 100V DC (Class 3) Duration: 60±5 sec.
5.	Insulation Resistance	Between terminals	10000MΩ min.	1000MΩ min. Applied voltage: Rated voltage Duration: 60±5 sec. Charge/discharge current shall not exceed 10mA. (Class 3)
6.	Capacitance and Tolerance	1pF, 2pF : ± 0.5pF 10pF~43pF : ±10% 82pF : ± 20/10 % ※But series G110pF±20%82pF±10%	1000pF: ± 100/0 % 2000pF: ± 80/20 %	Measuring frequency: 1MHz±20% (Class 1) 1KHz±20% (Class 3) Measuring voltage: 1.0±0.5Vrms Bias application: None
7.	Q or Tangent of Loss Angle (tanδ)	See the attached table.		
8.	Temperature Characteristic of Capacitance, without voltage application	SL: +350 to -1000ppm/°C	Y: ±22%	According to JIS C 5102 clause 7.12. Measurement of capacitance at 20°C and 85°C shall be made to calculate temperature characteristic by the following equation. (Class 1) $\frac{(C_{85} - C_{20})}{C_{20} \times \Delta T} \times 10^6 \text{ (ppm/°C)}$ (Class 2, 3) Change of maximum capacitance deviation in step 1 to 5 Temperature at step 1: 20°C Temperature at step 2: -25°C Temperature at step 3: 20°C (Reference temperature) Temperature at step 4: 85°C Temperature at step 5: 20°C
9.	Terminal Strength	Tensile	No abnormalities, such as cuts or looseness of terminals	Applied force : 10N (Leaded type G series) Duration: 5sec.
		Torsional	No abnormality such as cut lead, or looseness.	Fix the body, incline the terminal end through angle of 45° and return it to initial position. Then second bend in the opposite direction shall be made. Number of bends: 2 times
10.	Resistance to Vibration	Appearance: No significant abnormality Capacitance change: Shall satisfy the initial characteristic.		According to JIS C 5102 clause 8.2. Vibration type: A Directions: 2hrs each in X, Y, and Z directions Total: 6hrs Frequency range: 10 to 55 to 10Hz (1min.) Amplitude: 1.5mm Mounting method: Soldering onto PC board
11.	Solderability	At least 75% of terminal electrode is covered by new solder.		According to JIS C 5102 clause 8.4. Solder temperature: 230±5°C
12.	Damp Heat	Appearance: No significant abnormality Capacitance change: Within ±5.0% or ±0.5pF, whichever is larger. Q: 1pF or 2pF : 50min. 10pF to 82pF : 75 min.	Appearance: No significant abnormality Capacitance change : Within ±20% tanδ : 7.5%max.	Temperature: 40±2°C Humidity: 90 to 95% RH Duration: 500 ± 24/0 hrs Recovery: 1hr of recovery under the standard condition after the removal from test chamber.

FEEDTHROUGH CERAMIC CAPACITORS (STEPPED TYPE)

No. Item	Specified Value		Test Methods and Remarks
	Stepped feed-through capacitor		
	series G		
	(Class 1)	(Class 3)	
13. Loading under Damp Heat	Appearance : No significant abnormality Capacitance change : Within $\pm 5.0\%$ or ± 0.5 pF, whichever is the larger. Q : 1pF or 2pF : 50min. 10pF to 82pF : 75min.	Appearance : No significant abnormality Capacitance change : Within $\pm 20\%$ $\tan \delta$: 7.5% max.	Duration: $500 \pm \frac{24}{0}$ hrs Applied voltage: Rated voltage Recovery: 1 hr of recovery under the standard condition after the removal from test chamber.
14. High Temperature Loading Test	Appearance : No significant abnormality Capacitance change : Within $\pm 5.0\%$ or ± 0.5 pF, whichever is the larger. Q : 1pF, 2pF : 50 min. 10pF to 82pF : 75 min.	Appearance : No significant abnormality Capacitance change : Within $\pm 20\%$ $\tan \delta$: 7.5% max.	According to JIS C 5102 clause 9.10. Temperature: $85 \pm 2^\circ\text{C}$ Humidity: 90 to 95% RH Duration: $1000 \pm \frac{48}{0}$ hrs Applied voltage: Rated voltage $\times 2$ Recovery: 1 to 2 hrs of recovery under the standard condition after the removal from test chamber. Charge/discharge current shall not exceed 50mA. (Class 1) Charge/discharge current shall not exceed 10mA. (Class 3)

Withstanding voltage is also referred to as "voltage proof" under IEC specifications.

FEEDTHROUGH CERAMIC CAPACITORS (STEPPED TYPE)

Stages	Precautions	Technical considerations
1. Circuit Design	<p>◆Verification of operating environment, electrical rating and performance</p> <p>1. A malfunction in medical equipment, spacecraft, nuclear reactors, etc. may cause serious harm to human life or have severe social ramifications. As such, any capacitors to be used in such equipment may require higher safety and/or reliability considerations and should be clearly differentiated from components used in general purpose applications.</p> <p>◆Operating Environment precautions</p> <p>1. capacitors should not used in the following environments:</p> <p>(1)Environmental conditions to avoid</p> <p>a. exposure to water or salt water.</p> <p>b. exposure to moisture or condensation.</p> <p>c. exposure to corrosive gases (such as hydrogen sulfide, sulfurous acid, chlorine, and ammonia)</p>	