

2014 **C**hip Resistors

Product catalog

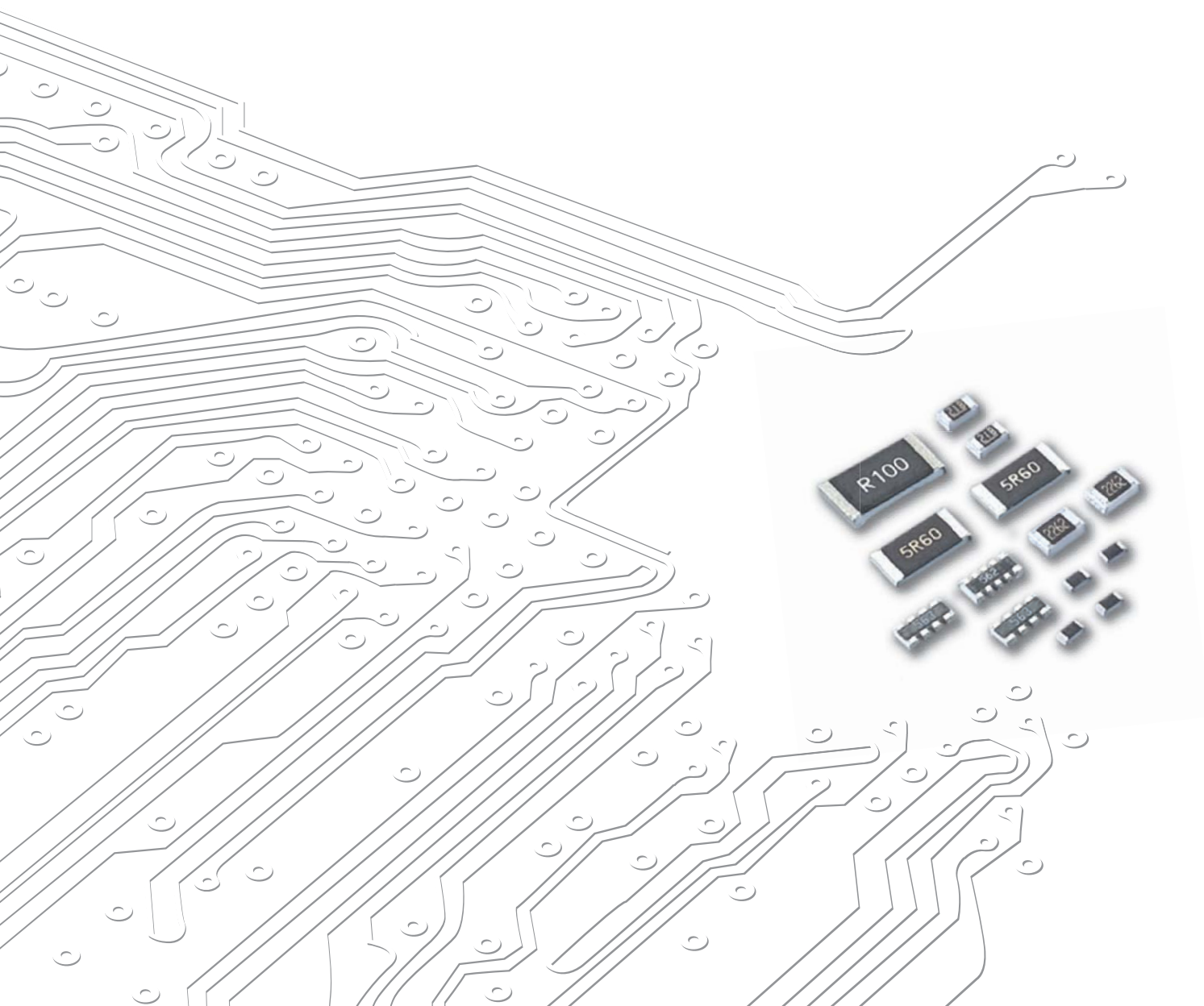

Product Portfolio

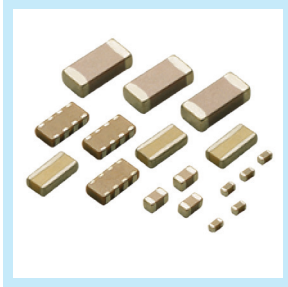

Multilayer Ceramic Capacitors (MLCC)

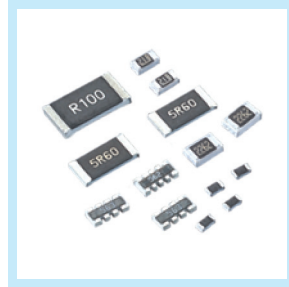

Chip-Resistor

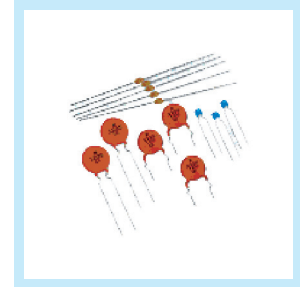

Disc Capacitors



RF Device and High Frequency Inductors

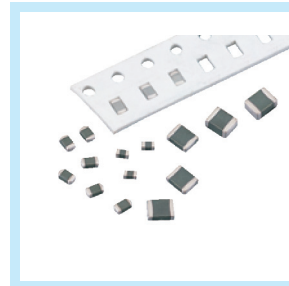

Varistors and SMD-Varistors

IEC-63 Nominal Resistance / Capacitance

E1	100																							
E3	100				220				470															
E6	100	150	220	330	470	680																		
E12	100	120	150	180	220	270	330	390	470	560	680	820												
E24	100	110	120	130	150	160	180	200	220	240	270	300	330	360	390	430	470	510	560	620	680	750	820	910
E96	100	102	121	124	147	150	178	182	215	221	261	267	316	324	383	392	464	475	562	576	681	698	825	845
	105	107	127	130	154	158	187	191	226	232	274	280	332	340	402	412	487	499	590	604	715	732	866	887
	110	113	133	137	162	165	196	200	237	243	287	294	348	357	422	432	511	523	619	634	750	768	909	931
	115	118	140	143	169	174	205	210	249	255	301	309	365	374	442	453	536	549	649	665	787	806	953	976

E6: $\sqrt[6]{10} \approx 1.46$ E12: $\sqrt[12]{10} \approx 1.21$

E1 series resistance: 1Ω, 10Ω, 100Ω, 1000Ω, 10000Ω, 100000Ω

INDEX

Subject	Page
How to Order.....	1
Chip resistors Selection Guide	2
General Purpose Chip Resistors (1Ω ~10MΩ)	5
Thick Film Low Ohm/ Power Low Ohm Chip Resistors (0.02Ω ~ 0.976Ω)	6
Metal Low Ohm Current Sensing Chip resistors (0.001Ω ~ 0.050Ω)	7
Chip Resistor Array:Convex Termination	8
WA06W Chip Resistor Array 16P8R	9
Chip Resistor Array:Concave Termination	10
WT04X Chip Resistor Network	11
WA04P Chip Attenuator	12
Special Chip Resistors	13
MR/SR Series of Automotive & Anti-Sulfuration Chip Resistors.....	13
WR_R Series of Total Lead Free Chip Resistors	13
WKxxM Series of Trimmable Chip Resistors	14
WKxxV Series of High Voltage Chip Resistors.....	14
WFxxP Series of High Power Chip Resistors	15
WKxxS series of Surge Chip Resistors	15
High Precision Chip Resistors	16
Test and Requirements	17
Packing on Tape and Reel	19
Footprint Design	20
Storage and Handling Condition.....	21
Recommendation of Soldering Profiles	21

*The specifications are subject to change or our products in it may be discontinued without advance notice. Please check with our sales representatives or product engineers before ordering.

*This catalog has only typical specifications because there is no space for detailed specifications. Therefore, please approve our product specifications or transact the approval sheet for product specification before ordering.

HOW TO ORDER

WR	12	X	1000	F	T	L
Type code WR : General 1~10MR MR : Automotive SR : Anti-Sulfuration ZR : Non magnetic	Size code 25 : 2512 (6432) 20 : 2010 (5025) 18 : 1218 (3248) 12 : 1206 (3216) 10 : 1210 (3225) 08 : 0805 (2012) 06 : 0603 (1608) 04 : 0402 (1005) 02 : 0201 (0603) 01 : 01005 (0402)	Functional code X : 5% for 1 ~ 10MΩ 1% for 10 ~ 1MΩ W : 1% for <10Ω and >1MΩ Y : 5% for 1 ~ 10MΩ (Low profile) 1% for 10 ~ 1MΩ (Low profile) Z : 1% for <10Ω or >1MΩ (Low profile) F : TC100 1-10ohm, 1% E : TC100, 100-1Mohm, 5%	Resistance E24(J tol.) : 2 significant digits followed by No. of zeros and a blank e.g. : 3ohm = 3R0_ 10ohm = 100_ 220ohm = 221_ 56Kohm = 563_ (" " means blank) E24+E96 (F tol.) : 3 significant digits followed by No. of zeros e.g. : 3Ω = 3R00 10Ω = 10R0 220Ω = 2200 56KΩ = 5602	Tolerance F : ± 1% J : ± 5% P : Jumper H : +5% ~ 0% S : -16.5% ~ -15% X : random	Packaging code P : 4" reel taping T : 7" reel taping A : 7" reel taping 15Kpcs D : 7" reel taping 20Kpcs E : 7" up side down taping V : 7" reel taping 1Kpcs Q : 10" reel taping G : 13" reel taping H : 0402-50K/13" reel R : 0603 2mm pitch taping B : Bulk K : Bulkcase C : Bulk after measuring F : 0402 1mm pitch (30k/ 7" reel)	Termination code L = Sn base (Lead free) R = Pb ≤ 100ppm (total) W = Wide term. A = Anti-leaching
WW	12	M	R002	F	T	L
Type code WW: R < 1Ω MW: R < 1Ω, AUTO SW: R < 1Ω, Anti-Sulfu	Size code 25 : 2512 (6432) 20 : 2010 (5025) 18 : 1218 (3248) 12 : 1206 (3216) 10 : 1210 (3225) 08 : 0805 (2012) 06 : 0603 (1608) 04 : 0402 (1005)	Functional code X : Thick film low ohm W : Thick film low ohm low TCR Q : Metal low ohm M : Metal low ohm R : Metal low ohm high power N : Metal low ohm high power P : Thick film low TCR high Power 2512 = 2W 2010 = 1W 1210 = 0.5W 1206 = 0.5W C : Thick film Power low ohm up side down E : Thick film Power low ohm low cost, up side down	Resistance R followed by 3 significant digits e.g. : 0.1Ω = R100 0.033Ω = R033 0.56Ω = R560	Tolerance F : ± 1% G : ± 2% J : ± 5%	Packaging code P : 4" reel taping T : 7" reel taping Q : 10" reel taping R : 13" reel taping G : 0603 2mm pitch taping B : Bulk K : Bulkcase	Termination code L = Sn base (Lead free) G = Au base S = Ag base
WF	12	T	1001	B	T	L
Type code WF : Special function MF : Special function AUTO SF : Special function Anti-S WK : Special function made in KM	Size code 25 : 2512 (6432) 20 : 2010 (5025) 18 : 1218 (3248) 12 : 1206 (3216) 10 : 1210 (3225) 08 : 0805 (2012) 06 : 0603 (1608) 04 : 0402 (1005)	Functional code G : High ohm (>10MΩ) H : Thick film, High Precision <1% K : Thick film, TCR50ppm M : Trimmable P : High Power S : Surge T : Thin film, TCR50ppm U : Thin film, TCR25ppm Q : Thin film, TCR50ppm, power R : Thin film, TCR25ppm, power F : Thin film TCR15ppm W : Thin film TCR10ppm Z : Thin film TCR 5ppm V : High voltage X : Special resistance Y : E24/E96 resistance with special termination A : Hi-power 2010, 1.5W	Resistance E24(J tol.) : 2 significant digits followed by No. of zeros and a blank e.g. : 3ohm = 3R0_ 10ohm = 100_ 220ohm = 221_ 56Kohm = 563_ (" " means blank) E24+E96 (F tol.) : 3 significant digits followed by No. of zeros e.g. : 3Ω = 3R00 10Ω = 10R0 220Ω = 2200 56KΩ = 5602	Tolerance A : ± 0.05% B : ± 0.1% C : ± 0.25% D : ± 0.5% F : ± 1% G : ± 2% J : ± 5% K : ± 10% L : ± 15% M : ± 20% P : Jumper X : 0/-30% Y : 0/-20% Z : 0/-10% Q : -0.8%~-1.0% R : +0.8%~-1.0% E : -10% ~ -9%	Packaging code P : 4" reel taping T : 7" reel taping Q : 10" reel taping G : 13" reel taping R : 0603 2mm pitch taping B : Bulk K : Bulkcase D : 7" reel taping 20Kpcs V : 7" reel taping 1Kpcs A : 7" reel taping 15Kpcs	Termination code L = Sn base (Lead free) G = Au base S = Ag base C = Cu base D = Cu base + Low profile
WA	04	X	103	J	T	L
Type code WA: Array MA: Convex Array Auto SA: Concave Array Anti-Sulfur	Size code 06 : 0603 (1608) 04 : 0402 (1005) 02 : 0201 (0603)	Functional code X : *4, convex Y : *2, convex W : *8, convex T : *4, concave U : *2, concave P : *3, convex (Attenuator) A : *4, FLAT B : *2, FLAT F : *4, Reverse array G : *2, Reverse array	Resistance E24(J tol.) : 2 significant digits followed by No. of zeros and a blank e.g. : 3ohm = 3R0_ 10ohm = 100_ 220ohm = 221_ 56Kohm = 563_ (" " means blank) E24+E96 (F tol.) : 3 significant digits followed by No. of zeros e.g. : 3Ω = 3R00 10Ω = 10R0 220Ω = 2200 56KΩ = 5602	Tolerance F : ± 1% J : ± 5% P : Jumper	Packaging code T : 7" reel taping A : 7" reel taping 15Kpcs Q : 10" reel taping G : 13" reel taping B : Bulk K : Bulkcase	Termination code L = Sn base (Lead free)
WT	04	X	103	J	T	L
Type code T : Network Resistors	Size code 04 : total package size 1206 (3216)	Functional code X : *8, convex	Resistance E24(J tol.) : 2 significant digits followed by No. of zeros and a blank e.g. : 3ohm = 3R0_ 10ohm = 100_ 220ohm = 221_ 56Kohm = 563_ (" " means blank)	Tolerance J : ± 5% P : Jumper	Packaging code T : 7" reel taping B : Bulk	Termination code L = Sn base (Lead free)

Remark :

1. Detail product part number, functional code, tolerance combination,..... please refer to specific data sheet.
2. Example : (" " means a blank)
Chip-R 0805 size, 4.3ohm, 5%, Normal type, SnPb termination, 5000pcs taped in reel : WR08X4R3_JTL
3. 1218 standard packing q'ty is 3Kpcs in 10" reel and packing code is T code

Chip Resistor Selection Guide

General Purpose Chip-R

Series	Size	Rated Power	TCR (ppm/°C)*	Tolerance	Resistance
WR25X	2512 (6432)	1W	±100	±1%	1 ~ 10MΩ
			±200	±5%	
WR18X	1218 (3248)	1W	±100	±1%	
			±200	±5%	
WR20X	2010 (5025)	1/2W	±100	±1%	
			±200	±5%	
WR10X	1210 (3225)	1/3W	±100	±1%	
			±200	±5%	
WR12X	1206 (3216)	1/4W	±100	±1%	
				±5%	
WR08X	0805 (2012)	1/8W		±1%	
				±5%	
WR06X	0603 (1608)	1/10W		±1%	
				±5%	
WR04X	0402 (1005)	1/16W		±1%	
				±5%	
WR02X	0201 (0603)	1/20W	±200	±1%	
			±200	±5%	
WR01X	01005 (0402)	1/32W	±200	±1%	4.7 ~ 1MΩ
			±200	±5%	

- Remark:**
- Detailed resistance vs. TCR and ordering code please refer to specific specifications.
 - Jumper resistor is not designed for fusing applications, designers shall apply dedicate fusible resistor or standard fuse in application circuits.
 - WRxxW defines for ±1% < 10ohm or > 1Mohm.

Thick Film Low Ohm Chip-R

Series	Size	Rated Power	TCR (ppm/°C)	Tolerance	Resistance
WW25X WW25W	2512 (6432)	1W	≤ 1500**	±1%, ±5%	0.015Ω ~ 0.976Ω
			±1000**	±1%, ±5%	0.010Ω ~ 0.100Ω
WW18X	1218 (3248)	1W	≤ 1500**	±1%	0.020Ω ~ 0.976Ω
				±5%	0.015Ω ~ 0.976Ω
WW20X WW20W	2010 (5025)	1/2W 3/4W	≤ 1500**	±1%, ±5%	0.020Ω ~ 0.976Ω
			±1000**	±1%, ±5%	0.010Ω ~ 0.100Ω
WW10X WW10W	1210 (3225)	1/3W 2/3W	±200	±1%, ±5%	0.100Ω ~ 0.976Ω
			±500**	±1%, ±5%	0.030Ω ~ 0.100Ω
WW12X WW12W	1206 (3216)	1/4W 1/3W	≤ 1500**	±1%, ±5%	0.020Ω ~ 0.976Ω
			±1000**	±1%, ±5%	0.010Ω ~ 0.100Ω
WW08X WW08W	0805 (2012)	1/8W	≤ 1500**	±1%, ±5%	0.020Ω ~ 0.976Ω
			±200	±1%, ±5%	0.050Ω ~ 0.100Ω
WW06X WW06W	0603 (1608)	1/10W	≤ 500**	±1%, ±5%	0.100Ω ~ 0.976Ω
			±400	±1%, ±5%	0.050Ω ~ 0.100Ω
WW04X	0402 (1005)	1/16W	≤ 600**	±1%, ±5%	0.100Ω ~ 0.976Ω

- Remark:**
- Detailed resistance vs. TCR and ordering code please refer to specific specifications.
 - Resistance value will be changed by soldering condition and design of soldering pad, please design products in consideration of this change.

Thick Film Power Low Ohm Chip-R

Series	Size	Rated Power	TCR (ppm/°C)	Tolerance	Resistance
WW25P	2512 (6432)	2W	< 0.1Ω: 150ppm ≥ 0.1Ω: 100ppm	±1%, ±5%	0.047Ω ~ 0.976Ω
WW20P	2010 (5025)	1W	< 0.1Ω: 150ppm ≥ 0.1Ω: 100ppm	±1%, ±5%	0.047Ω ~ 0.976Ω
WW10P	1210 (3225)	1/2W	< 0.1Ω: 500ppm ≥ 0.1Ω: 200ppm	±1%, ±5%	0.020Ω ~ 0.976Ω
WW12P	1206 (3216)	1/2W	< 0.1Ω: 200ppm ≥ 0.1Ω: 100ppm	±1%, ±5%	0.020Ω ~ 0.976Ω
WW08P	0805 (2012)	1/3W	< 0.1Ω: 200ppm ≥ 0.1Ω: 150ppm	±1%, ±5%	0.047Ω ~ 0.976Ω
WW06P	0603 (1608)	1/4W	< 0.1Ω: 250ppm ≥ 0.1Ω: 200ppm	±1%, ±5%	0.047Ω ~ 0.976Ω
WW04P	0402 (1005)	1/8W	< 0.1Ω: 300ppm ≥ 0.1Ω: 200ppm	±1%, ±5%	0.100Ω ~ 0.976Ω
WW12C	1206 (3216)	1/2W	< 0.02Ω: 150ppm ≥ 0.02Ω: 100ppm	±1%, ±5%	0.020Ω ~ 0.100Ω
WW08C	0805 (2012)	1/3W	< 0.03Ω: 200ppm ≥ 0.03Ω: 100ppm	±1%, ±5%	0.010Ω ~ 0.050Ω
WW06C	0603 (1608)	1/4W	< 0.051Ω: 0~+250ppm ≥ 0.051Ω: ±150ppm	±1%, ±5%	0.010Ω ~ 0.100Ω
WW04C	0402 (1005)	1/8W	< 0.051Ω: 0~+350ppm ≥ 0.051Ω: ±150ppm	±1%, ±5%	0.025Ω ~ 0.100Ω
WW02C	0201 (0603)	1/10W	< 0.033Ω: 500ppm < 0.051Ω: 300ppm ≥ 0.051Ω: 100ppm	±1%, ±5%	0.020Ω ~ 0.100Ω

Metal Low Ohm Sensing Type Chip-R

Series	Size	Rated Power	TCR (ppm/°C)*	Tolerance	Resistance
WW59M	5931 (15079)	5W	±100	±1%, ±5%	2, 3, 5mΩ
WW25N	2512 (6432)	2W	±100	±1%, ±5%	3, 5, 10, 15, 20, 25mΩ
WW25R		2W	±100	±1%, ±5%	1, 2, 3, 4, 5, 6, 7, 10mΩ
WW25M		1W	±100	±1%, ±5%	3, 5, 10, 15, 20, 25, 50mΩ
WW25Q		1W	±100	±1%, ±5%	1, 2, 3, 4, 5, 6, 7, 8, 9, 10, 11, 12, 13, 14, 15mΩ
WW20N	2010 (5025)	1W	±75	±1%, ±5%	5, 10, 15, 20mΩ
WW12N	1206 (3216)	1W	±70	±1%, ±5%	5, 10, 15, 20, 25mΩ
WW12R		1W	±100	±1%, ±5%	1 ~ 15mΩ
WW12D		1W	±100	±1%, ±5%	20, 25, 30, 40, 50mΩ
WW08R	0805 (2012)	1/2W	±100	±1%, ±5%	4, 5, 10mΩ
WW08D	0805 (2012)	1/2W	±100	±1%, ±5%	20, 25, 30, 40, 50mΩ
WW06R	0603 (1608)	1/3W	±100	±1%, ±5%	5, 10, 15mΩ

Remark:

- Detailed resistance vs. TCR and ordering code please refer to specific specifications.
- Resistance value will be changed by soldering condition and design of soldering pad, please design products in consideration of this change.

Chip Resistor Array

Series	Size	Rated Power	TCR (ppm/°C)	Termination	Tolerance	Resistance
WA06X	1206 (0603x4)	1/10W	±200	Convex	±1%, ±5%	10 ~ 1MΩ
WA06T	1206 (0603x4)	1/10W	±200	Concave	±1%, ±5%	
WA06Y	0606 (0603x2)	1/10W	±200	Convex	±1%, ±5%	
WA04X	0804 (0402x4)	1/16W	±200	Convex	±1%, ±5%	
WA04T	0804 (0402x4)	1/16W	±300	Concave	±1%, ±5%	
WA04Y	0404 (0402x2)	1/16W	±200	Convex	±1%, ±5%	
WA04U	0404 (0402x2)	1/16W	±300	Concave	±1%, ±5%	10 ~ 100KΩ
WA06W	1606 (0402x8)	1/16W	±200	Convex	±1%, ±5%	
WA02Y	0806 (0201x2)	1/32W	±300	Convex	±1%, ±5%	10 ~ 1MΩ
WA02A	1406 (0201x4)	1/32W	±200	Flat	±1%, ±5%	±5%: 10 ~ 1MΩ; ±1%: 10 ~ 100KΩ
WA02B	0806 (0201x2)	1/32W	±200	Flat	±1%, ±5%	

Remark:

- Detailed resistance vs. TCR and ordering code please refer to specific specifications.
- Resistance value will be changed by soldering condition and design of soldering pad, please design products in consideration of this change.

Chip Attenuator

Series	Size	Type	Termination	Tolerance	Attenuation	Impedance
WA04P	0404 (0402x2)	4P3R, Π type	Convex	±0.1dB ~ 2.5dB	0, 0.5dB ~ 20dB	50Ω

Chip Resistor Network

Series	Size	Rated Power	TCR (ppm/°C)	Termination	Tolerance	Resistance
WT04X	1206 (10P8R)	1/16W	±200	Convex	±5%	10 ~ 100KΩ

High Power Chip-R

Series	Size	Rated Power	TCR (ppm/°C)	Tolerance	Resistance
WF25P	2512 (6432)	2W	±100	±1%, ±5%	Jumper; 1 ~ 1MΩ
WF20P	2010 (5025)	1W	±100		
WF10P	1210 (3225)	1/2W	±100		
WF12P	1206 (3216)	1/2W	±100		
WF08P	0805 (2012)	1/4W	±100		
WF06P	0603 (1608)	1/8W	±100		
WF04P	0402 (1005)	1/8W	±100		

Automotive Chip-R

Series	Size	Rated Power	TCR(ppm/°C)	Tolerance	Resistance
MR12	1206 (3216)	1/4W	±200	±1%, ±5%	1 ~ 10MΩ
MR08	0805 (2012)	1/8W	±200		1 ~ 10MΩ
MR06	0603 (1608)	1/10W	±200		1 ~ 10MΩ
MR04	0402 (1005)	1/16W	±200		1 ~ 10MΩ

Anti-Sulfuration Chip-R

Series	Size	Rated Power	TCR(ppm/°C)	Tolerance	Resistance
SR12	1206 (3216)	1/4W	≤200	±1%, ±5%	1 ~ 10MΩ
SR08	0805 (2012)	1/8W	≤200	±1%, ±5%	1 ~ 10MΩ
SR06	0603 (1608)	1/10W	≤200	±1%, ±5%	1 ~ 10MΩ
SR04	0402 (1005)	1/16W	≤200	±1%, ±5%	1 ~ 10MΩ

Surge Chip-R

Series	Size	Rated Power	TCR(ppm/°C)	Tolerance	Resistance
WK25S	2512 (6432)	1W	≤200	±5%, ±10%	0.27 ~ 22MΩ
WK20S	2010 (5025)	3/4W	≤200	±5%, ±10%	0.27 ~ 22MΩ
WK10S	1210 (3225)	1/2W	≤200	±5%, ±10%	0.27 ~ 22MΩ
WK12S	1206 (3216)	1/4W	≤200	±5%, ±10%	0.27 ~ 22MΩ
WK08S	0805 (2012)	1/8W	≤200	±5%, ±10%	0.27 ~ 22MΩ

High Ohm Chip-R

Series	Size	Rated Power	TCR(ppm/°C)	Tolerance	Resistance
WF12G	1206 (3216)	1/4W	≤ 200	±1%, ±5%	11M~100MΩ
WF08G	0805 (2012)	1/8W	≤ 200	±1%, ±5%	11M~100MΩ
WF06G	0603 (1608)	1/10W	≤ 200	±1%, ±5%	11M~100MΩ
WF04G	0402 (1005)	1/16W	≤ 300	±5%	11M~30MΩ

High Voltage Chip-R

Series	Size	Rated Power	TCR(ppm/°C)	Voltage (V)	Tolerance	Resistance
WK25Z	2512 (6432)	1W	≤ 200	2000	±5%, ±10%, ±20%	4.7M ~ 16MΩ
WK20Z	2010 (5025)	1/2W	≤ 200	1500	±5%, ±10%, ±20%	1M ~ 16MΩ
WK25V	2512 (6432)	1W	≤ 200	800	±1%, ±5%	47~ 51MΩ
WK20V	2010 (5025)	1/2W	≤ 200	500	±1%, ±5%	47~ 51MΩ
WK12V	1206 (3216)	1/4W	≤ 200	500	±1%, ±5%	47~ 51MΩ
WK08V	0805 (2012)	1/8W	≤ 200	400	±1%, ±5%	47~ 51MΩ
WK06V	0603 (1608)	1/10W	≤ 200	200	±1%, ±5%	47~ 10MΩ

Trimmable Chip-R

Series	Size	Rated Power	TCR(ppm/°C)	Tolerance	Resistance
WK25M	2512 (6432)	1W	≤ 200	0/-20%, 0/-30%	1 ~ 4.7MΩ
WK20M	2010 (5025)	1/2W	≤ 200	0/-20%, 0/-30%	1 ~ 4.7MΩ
WK10M	1210 (3225)	1/4W	≤ 200	0/-20%, 0/-30%	1 ~ 4.7MΩ
WK12M	1206 (3216)	1/8W	≤ 200	0/-20%, 0/-30%	1 ~ 4.7MΩ
WK08M	0805 (2012)	1/10W	≤ 200	0/-20%, 0/-30%	1 ~ 4.7MΩ
WK06M	0603 (1608)	1/16W	≤ 100	0/-20%, 0/-30%	10~ 4.7MΩ

Total lead free Chip-R (Pb < 100ppm)

Series	Size	Rated Power	TCR(ppm/°C)	Tolerance	Resistance
WR10X_R	1210 (3225)	1/3W	≤ 200	±1%, ±5%	1~ 10MΩ
WR12X_R	1206 (3216)	1/4W	≤ 200	±1%, ±5%	1~ 10MΩ
WR08X_R	0805 (2012)	1/8W	≤ 200	±1%, ±5%	1~ 10MΩ
WR06X_R	0603 (1608)	1/10W	≤ 200	±1%, ±5%	1~ 10MΩ
WR04X_R	0402 (1005)	1/16W	≤ 200	±1%, ±5%	1~ 10MΩ
WR02X_R	0201 (0603)	1/20W	≤ 200	±1%, ±5%	1~ 10MΩ
WA04X_R	0402X4	1/16W	≤ 200	±1%, ±5%	10 ~ 1MΩ
WA06X_R	0603X4	1/10W	≤ 200	±1%, ±5%	10 ~ 1MΩ

High Precision Chip-R

Series	Size	Rated Power	TCR(ppm/°C)	Tolerance	Resistance
WF10H	1210 (3225)	1/3W	≤ 100	±0.1%, ±0.5%	10 ~ 1MΩ
WF12H	1206 (3216)	1/4W	≤ 100	±0.1%, ±0.5%	10 ~ 1MΩ
WF08H	0805 (2012)	1/8W	≤ 100	±0.1%, ±0.5%	10 ~ 1MΩ
WF06H	0603 (1608)	1/10W	≤ 100	±0.1%, ±0.5%	10 ~ 1MΩ
WF04H	0402 (1005)	1/16W	≤ 100	±0.1%, ±0.5%	10 ~ 1MΩ
WF25T	2512 (6432)	3/4W	≤ 50	±0.05%, ±0.10%, ±0.25%, ±0.50%, ±1.0%	10 ~ 1.5MΩ
WF25Q	2512 (6432)	1W	≤ 50	±0.05%, ±0.10%, ±0.25%, ±0.50%, ±1.0%	10 ~ 1.5MΩ
WF20T	2010 (5025)	1/2W	≤ 50	±0.05%, ±0.10%, ±0.25%, ±0.50%, ±1.0%	10 ~ 1.5MΩ
WF20Q	2010 (5025)	3/4W	≤ 50	±0.05%, ±0.10%, ±0.25%, ±0.50%, ±1.0%	10 ~ 1.5MΩ
WF10T	1210 (3225)	1/4W	≤ 50	±0.05%, ±0.10%, ±0.25%, ±0.50%, ±1.0%	10 ~ 1MΩ
WF10Q	1210 (3225)	2/5W	≤ 50	±0.05%, ±0.10%, ±0.25%, ±0.50%, ±1.0%	10 ~ 1MΩ
WF12T	1206 (3216)	1/8W	≤ 50	±0.05%, ±0.10%, ±0.25%, ±0.50%, ±1.0%	4.7 ~ 1MΩ
WF12Q	1206 (3216)	1/4W	≤ 50	±0.05%, ±0.10%, ±0.25%, ±0.50%, ±1.0%	4.7 ~ 1MΩ
WF08T	0805 (2012)	1/10W	≤ 50	±0.05%, ±0.10%, ±0.25%, ±0.50%, ±1.0%	4.7 ~ 1MΩ
WF08Q	0805 (2012)	1/8W	≤ 50	±0.05%, ±0.10%, ±0.25%, ±0.50%, ±1.0%	4.7 ~ 1MΩ
WF06T	0603 (1608)	1/16W	≤ 50	±0.05%, ±0.10%, ±0.25%, ±0.50%, ±1.0%	4.7 ~ 680KΩ
WF06Q	0603 (1608)	1/10W	≤ 50	±0.05%, ±0.10%, ±0.25%, ±0.50%, ±1.0%	4.7 ~ 680KΩ
WF04T	0402 (1005)	1/16W	≤ 50	±0.05%, ±0.10%, ±0.25%, ±0.50%, ±1.0%	10 ~ 100KΩ
WF25U	2512 (6432)	3/4W	≤ 25	±0.05%, ±0.10%, ±0.25%, ±0.50%, ±1.0%	10 ~ 1.5MΩ
WF25R	2512 (6432)	1W	≤ 25	±0.05%, ±0.10%, ±0.25%, ±0.50%, ±1.0%	10 ~ 1.5MΩ
WF20U	2010 (5025)	1/2W	≤ 25	±0.05%, ±0.10%, ±0.25%, ±0.50%, ±1.0%	10 ~ 1.5MΩ
WF20R	2010 (5025)	3/4W	≤ 25	±0.05%, ±0.10%, ±0.25%, ±0.50%, ±1.0%	10 ~ 1.5MΩ
WF10U	1210 (3225)	1/4W	≤ 25	±0.05%, ±0.10%, ±0.25%, ±0.50%, ±1.0%	10 ~ 1MΩ
WF10R	1210 (3225)	2/5W	≤ 25	±0.05%, ±0.10%, ±0.25%, ±0.50%, ±1.0%	10 ~ 1MΩ
WF12U	1206 (3216)	1/8W	≤ 25	±0.05%, ±0.10%, ±0.25%, ±0.50%, ±1.0%	4.7 ~ 1MΩ
WF12R	1206 (3216)	1/4W	≤ 25	±0.05%, ±0.10%, ±0.25%, ±0.50%, ±1.0%	4.7 ~ 1MΩ
WF08U	0805 (2012)	1/10W	≤ 25	±0.05%, ±0.10%, ±0.25%, ±0.50%, ±1.0%	4.7 ~ 1MΩ
WF08R	0805 (2012)	1/8W	≤ 25	±0.05%, ±0.10%, ±0.25%, ±0.50%, ±1.0%	4.7 ~ 1MΩ
WF06U	0603 (1608)	1/16W	≤ 25	±0.05%, ±0.10%, ±0.25%, ±0.50%, ±1.0%	4.7 ~ 680KΩ
WF06R	0603 (1608)	1/10W	≤ 25	±0.05%, ±0.10%, ±0.25%, ±0.50%, ±1.0%	4.7 ~ 680KΩ
WF04U	0402 (1005)	1/16W	≤ 25	±0.05%, ±0.10%, ±0.25%, ±0.50%, ±1.0%	10 ~ 100KΩ
WF12F	1206 (3216)	1/8W	≤ 15	±0.05%, ±0.10%, ±0.25%	25 ~ 300KΩ
WF08F	0805 (2012)	1/8W	≤ 15	±0.05%, ±0.10%, ±0.25%	25 ~ 200KΩ
WF06F	0603 (1608)	1/10W	≤ 15	±0.05%, ±0.10%, ±0.25%	25 ~ 100KΩ
WF04F	0402 (1005)	1/16W	≤ 15	±0.05%, ±0.10%, ±0.25%	25 ~ 20KΩ
WF12W	1206 (3216)	1/8W	≤ 10	±0.05%, ±0.10%, ±0.25%	25 ~ 300KΩ
WF08W	0805 (2012)	1/8W	≤ 10	±0.05%, ±0.10%, ±0.25%	25 ~ 200KΩ
WF06W	0603 (1608)	1/10W	≤ 10	±0.05%, ±0.10%, ±0.25%	25 ~ 100KΩ
WF04W	0402 (1005)	1/16W	≤ 10	±0.05%, ±0.10%, ±0.25%	25 ~ 20KΩ
WF12Z	1206 (3216)	1/8W	≤ 5	±0.05%, ±0.10%, ±0.25%	25 ~ 120KΩ
WF08Z	0805 (2012)	1/8W	≤ 5	±0.05%, ±0.10%, ±0.25%	25 ~ 80KΩ
WF06Z	0603 (1608)	1/10W	≤ 5	±0.05%, ±0.10%, ±0.25%	25 ~ 40KΩ
WF04Z	0402 (1005)	1/16W	≤ 5	±0.05%, ±0.10%, ±0.25%	25 ~ 8KΩ

General Purpose Chip Resistors (1Ω~10MΩ)

Feature

1. High reliability and stability
2. Reduced size of final equipment
3. Lower assembly costs
4. Higher component and equipment reliability
5. RoHs compliant and lead free products

Description

The resistors are constructed in a high grade ceramic body (aluminum oxide). Internal metal electrodes are added at each end and connected by a resistive paste that is applied to the top surface of the substrate. The composition of the paste is adjusted to give the approximate resistance required and the value is trimmed to within tolerance by laser cutting of this resistive layer.

The resistive layer is covered with a protective coat. Finally, the two external end terminations are added. For ease of soldering the outer layer of these end terminations is Tin solder (Pb free) alloy.

Quick Reference Data

Series No.	WR25X	WR20X	WR18X	WR10X	WR12X	WR08X	WR06X	WR04X	WR02X	WR01X
Size code	2512 (6432)	2010 (5025)	1218 (3248)	1210 (3225)	1206 (3216)	0805 (2012)	0603 (1608)	0402 (1005)	0201 (0603)	01005 (0402)
Resistance Range ±5% Tolerance (E24) ±1% Tolerance (E24+E96)	±5% (E24): 1Ω~10MΩ; Jumper ±1% (E2+E964): 1Ω~10MΩ									
TCR (ppm/°C) R>1MΩ 1MΩ≥R>10Ω R≤10Ω	≤±200 ≤±100 ≤±200		≤±200 ≤±100 ≤±200		≤±100 ≤±100 ≤±200			≤±200 ≤±300		≤±200 ≤±300
Max. dissipation @ Tamb=70°C	1.0 W	1/2 W	1.0 W	1/3 W	1/4 W	1/8 W	1/10 W	1/16 W	1/20 W	1/32 W
Max. Operation Voltage (DC or RMS)	250V	200V	200V	200V	200V	150V	50V	50V	25V	20V
Operation Temperature	-55 ~ +155°C								-55 ~ +125°C	
Basic Specification	JIS C 5201-1 / IEC 60115-1									

Note:

1. This is the maximum voltage that may be continuously supplied to the resistor element, see "IEC publication 60115-8".
2. Max. Operation Voltage: So called RCWW (Rated Continuous Working Voltage) is determined by

$$RCWW = \sqrt{\text{Rated Power} \times \text{Resistance Value}}$$
 or Max. RCWW listed above, whichever is lower.
3. Detailed TCR please refer to specific specification.

Physical Dimensions

Unit: mm

Size	2512 (6432)	2010 (5025)	1218 (3248)	1210 (3225)	1206 (3216)	0805 (2012)	0603 (1608)	0402 (1005)	0201 (0603)	01005 (0402)
L	6.40±0.20	5.00±0.20	3.05±0.15	3.10±0.10	3.10±0.10	2.00±0.10	1.60±0.10	1.00±0.05	0.60±0.03	0.40±0.02
W	3.20±0.20	2.50±0.20	4.60±0.20	2.60±0.10	1.60±0.10	1.25±0.10	0.80±0.10	0.50±0.05	0.30±0.03	0.20±0.02
T	0.60±0.10	0.55±0.10	0.55±0.10	0.55±0.10	0.60±0.15	0.50±0.15	0.45±0.15	0.35±0.05	0.23±0.03	0.13±0.02
Tb	0.90±0.25	0.60±0.25	0.50±0.25	0.50±0.20	0.45±0.20	0.40±0.20	0.30±0.15	0.25±0.10	0.15±0.05	0.10±0.03
Tt	0.65±0.25	0.65±0.25	0.45±0.25	0.50±0.20	0.50±0.20	0.40±0.20	0.30±0.10	0.20±0.10	0.10±0.05	0.08±0.03

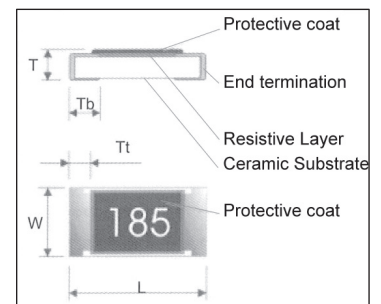

Power Deration Curve

For resistors operated in ambient temperature over 70°C, power rating should be derated in accordance with the following figures.

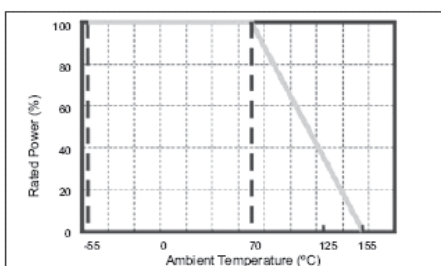

For Climatic category (IEC 60068) 55/155/56

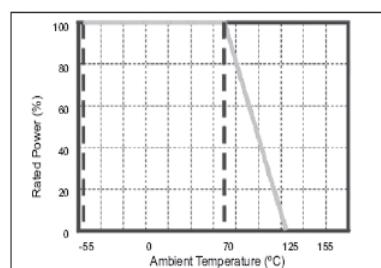

For Climatic category (IEC 60068) 55/125/56 (for 0201 type)

Thick Film Low Ohm/Power Low Ohm Chip Resistors

Function For Low Ohm Chip Resistors

The low ohmic resistors are used to sense output current in power supply, automotive and engine control management system, and other power sensing application. As shows in figure below, the typical function of low ohmic (power) chip resistor is to be a current sensor (R_{sense}) to generate the sensing voltage (V_s) for the purpose of feedback control when output current (I_o) passed on it. The sensing voltage be treated as a signal to trigger the switches (CMOS) ON/OFF duration so that to monitor and/or adjust the output current from inductor.

Simplify to say, $V_s = I_o \times R_{sense}$.

In general case, this feedback voltage is setting around 100mV for considering both on power saving and noise robustness. To sense a 5 ampere average output current, the R_{sense} resistance value therefore be required as $100mV / 5A = 20 m\Omega$, the power dissipation will be :

$$P = I^2 \times R = 5A^2 \times 20m\Omega = 0.5Watt$$

A low ohmic chip resistor with a power rating of 1.0 watt is recommended on this application in case the power safety margin is taken into account.

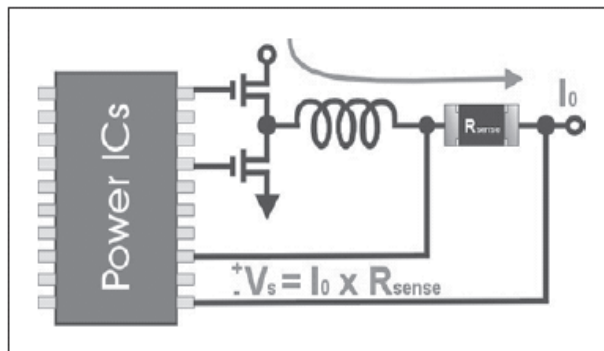

Quick Reference Data of Low Ohm Chip Resistor

Series No.	WW25X	WW20X	WW18X	WW10X	WW12X	WW08X	WW06X	WW04X
Size code	2512 (6432)	2010 (5025)	1218 (3248)	1210 (3225)	1206 (3216)	0805 (2012)	0603 (1608)	0402 (1005)
Resistance Tolerance	±5% , ±1%							
Resistance Range	0.020Ω ~ 0.976Ω					0.100Ω ~ 0.976Ω		
TCR (ppm/°C)	Detailed TCR please refer to specific data sheets							
Max. dissipation @ Tamb=70°C	1 Watt	0.5 Watt	1 Watt	1/3 Watt	1/4 Watt	1/8 Watt	1/10 Watt	1/16 Watt
Max. Operation Voltage (DC or RMS)	250V	200V	200V	200V	200V	100V	50V	50V
Operation Temperature	-55 ~ +155 °C							
Basic Specification	JIS C 5201-1 / IEC 60115-1							

Note :

1. This is the maximum voltage that may be continuously supplied to the resistor element, see "IEC publication 60115-9".
2. Power derating curve, and detail specification please refer to specific data sheets.
3. Resistance value will be changed by soldering condition and design of soldering pad, please design products in consideration of change of resistance value.

Quick Reference Data of Power Low Ohm Chip Resistor

Item	General Specification					
Series No.	WW25P	WW20P	WW12P	WW08P	WW06P	WW04P
Size code	2512 (6432)	2010 (5025)	1206 (3216)	0805(2012)	0603(1608)	0402(1005)
Resistance Tolerance	±5% , ±1%					
Resistance Range	0.047Ω ~ 0.976Ω					0.1Ω~0.976Ω
TCR (ppm/°C) <0.100Ω	±150ppm/°C	±150ppm/°C	±200ppm/°C	±200ppm/°C	±250ppm/°C	-
≥0.100Ω	±100ppm/°C	±100ppm/°C	±100ppm/°C	±150ppm/°C	±200ppm/°C	0~+300ppm/°C
Max. dissipation @ Tamb=70°C	2 W	1 W	1/2 W	1/3 W	1/4 W	1/8 W
Max. Operation Voltage (DC or RMS)	300V	200V	200V	150V	50V	50V
Operation Temperature	-55 ~ +155 °C					

Note :

1. This is the maximum voltage that may be continuously supplied to the resistor element, see "IEC publication 60115-8".
2. Max. Operation Voltage : So called RCWW (Rated Continuous Working Voltage) is determined by $RCWV = \sqrt{\text{Rated Power} \times \text{Resistance Value}}$ or Max. RCWV listed above, whichever is lower.
3. 2W loading with total solder-pad and trace size of 300mm²

Physical Dimensions

Unit: mm

Dimensions	WW25P	WW20P	WW12P	WW08P	WW06P	WW04P
L	6.30±0.20	5.00±0.20	3.10±0.15	2.00±0.15	1.60±0.10	1.00±0.05
W	3.10±0.20	2.50±0.20	1.60±0.15	1.20±0.15	0.80±0.10	0.50±0.05
T	0.60±0.15	0.60±0.10	0.55±0.10	0.50±0.10	0.45±0.10	0.35±0.05
Tt	0.60±0.25	0.60±0.25	0.50±0.25	0.40±0.20	0.30±0.20	0.20±0.10
Tb	1.80±0.25	0.65±0.25	0.50±0.25	0.40±0.20	0.30±0.20	0.25±0.05/-0.1

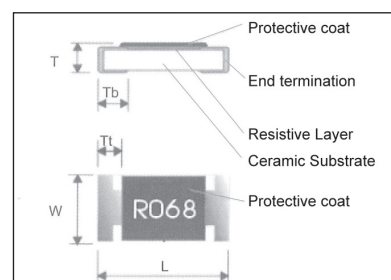

■ Metal Low Ohm Sensing Chip Resistors (0.001Ω~ 0.050Ω)

■ Description

The resistors are constructed in a high grade low resistive metal body. The resistive layer is covered with a protective coat and printed a resistance marking code over it. Finally, the two external end terminations are added. For ease of soldering the outer layer of these end terminations is a lead free terminations.

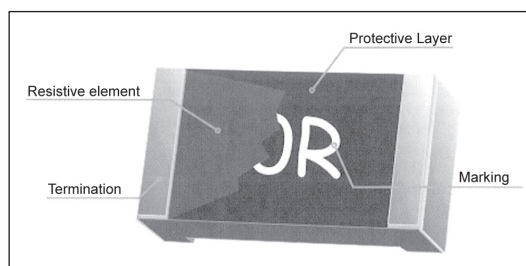

■ Quick Reference Data

Item	General Specification						
Series No.	WW25R	WW25Q	WW12R	WW12D	WW08R	WW08D	WW06R
Size code	2512 (6432)		1206(3216)		0805 (2012)		0603 (1608)
Resistance Tolerance	±5% , ±1%						
Resistance Range	1,2,3,4, 5,7,10mΩ	1 ~ 15mΩ	1 ~ 15mΩ	20, 25, 30, 40, 50mΩ	4, 5, 10mΩ	20, 25, 30, 40 50mΩ	5, 10, 15mΩ
TCR (ppm/°C)	±100ppm		±100ppm		±100ppm		±100ppm
Max. dissipation @ Tamb=70°C	2 W	1 W	1 W	1 W	1/2 W	1/2 W	1/3 W
Max. Operation Current (DC or RMS)	44.7A		14A		11A	5A	8.1A
Operation Temperature	-55 ~ +155°C						

Item	General Specification					
Series No.	WW25M	WW25N	WW20M	WW20N	WW12N	WW12M
Size code	2512 (6432)		2010 (5025)		1206(3216)	
Resistance Tolerance	±5% , ±1%					
Resistance Range	1~10, 12, 15, 20, 25, 30, 40, 50mΩ	1~10, 12, 15, 20, 25mΩ	5, 10, 15, 20mΩ		5, 10, 15, 20, 25mΩ	
TCR (ppm/°C)	1-4mΩ: ±100ppm; > 4m: ± 75 ppm/°C		± 75 ppm/°C		± 70 ppm/°C	
Max. dissipation @ Tamb=70°C	1 W	2 W	1/2 W	1 W	1 W	1/2 W
Max. Operation Voltage (DC or RMS)	250V		250V		200V	
Max. Overload Voltage (DC or RMS)	500V		500V		400V	
Operation Temperature	-55 ~ +155°C					

Note :

1. This is the maximum voltage that may be continuously supplied to the resistor element, see "IEC publication 60115-8" .
2. Power derating curve, and detail specification please refer to specific data sheets.
3. Resistance value will be changed by soldering condition and design of soldering pad, please design products in consideration of change of resistance value.

■ Physical Dimensions:

WW25M(0.002Ω~0.025Ω), WW25N(0.003Ω~0.025Ω), WW20N, WW12N

Unit: mm

Symbol	2512	2010	1206
L	6.40±0.20	5.00±0.20	3.10±0.20
W	3.20±0.20	2.50±0.20	1.60±0.20
T	0.60±0.15	0.60±0.15	0.60±0.25
Tt	0.65±0.25	0.65±0.25	0.60±0.20
Tb	0.65±0.25	0.65±0.25	0.60±0.20

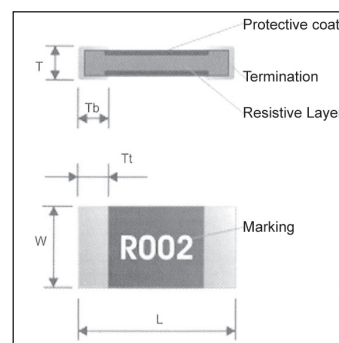

WW25M(0.001Ω), WW25N(0.001Ω~0.002Ω)

Unit: mm

Symbol	2512
L	6.40±0.20
W	3.20±0.20
T	0.60±0.10
Tt	1.60±0.25
Tb	1.60±0.25

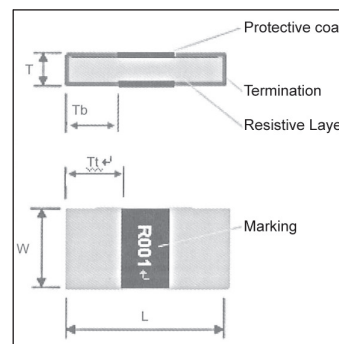

WW25Q, WW25R, WW12R, WW12D, WW06R

Note : 1. The detailed dimensions please refer to data sheet per type!

Chip Resistors Array : Convex Termination

Feature

1. High reliability and stability
2. Reduced size of final equipment
3. Lower assembly cost and higher surface mounted efficiency
4. Higher component and equipment reliability

Application

1. Consumer electrical equipment, PDA Digital Camcorder,
2. EDP, Computer application
3. Mobile phone, Telecom
4. DIMM

Description and Physical Dimensions

The resistors array is constructed in a high grade ceramic body (aluminum oxide). Internal metal electrodes are added at each end and connected by a resistive paste that is applied to the top surface of the substrate. The composition of the paste is adjusted to give the approximate resistance required and the value is trimmed to within tolerance by laser cutting of this resistive layer.

The resistive layer is covered with a protective coat. Finally, the two external end terminations are added. For ease of soldering the outer layer of these end termination is Tin solder alloy. Marking code description is depended on component size and tolerance. Following figure shown the construction of a Chip-R array.

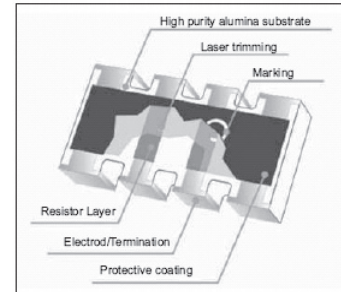

Physical Dimensions

Unit: mm

Type	WA06X	WA04X	WA06Y	WA04Y
L	3.20±0.10	2.00±0.10	1.60±0.10	1.00±0.10
W	1.60±0.10	1.00±0.10	1.50±0.10	1.00±0.10
T	0.50±0.10	0.45±0.10	0.50±0.10	0.35±0.10
P	0.80±0.10	0.50±0.05	1.00±0.10	0.65±0.10
A	0.60±0.10	0.40±0.10	0.60±0.10	0.34±0.10
B	0.30±0.10	0.20±0.10	0.30±0.15	0.20±0.15
C	0.40±0.10	0.30±0.05	-	-
G	0.30±0.20	0.25±0.10	0.30±0.15	0.25±0.17

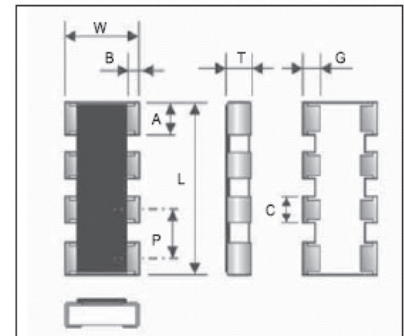

Quick Reference Data

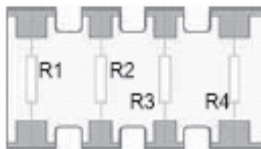
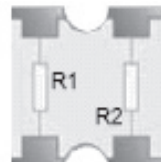
Series No.	WA06X	WA04X	WA06Y	WA04Y
Size	0603×4(1608×4)	0402×4(1005×4)	0603×2(1608×4)	0402×2(1005×2)
Termination construction	8P4R,Convex		4P2R,Convex	
Resistance Tolerance	±5%, ±1% (E24 series)			
Resistance Range	10Ω~1MΩ(E24 series), Jumper (0Ω)			
TCR (ppm/°C)	±200 ppm/°C			
Max. dissipation @ Tamb=70°C	1/10 Watt	1/16 Watt	1/10 Watt	1/16 Watt
Max. Operation Voltage (DC or RMS)	50V	50V	50V	25V
Max. Overload Voltage (DC or RMS)	100V	100V	100V	50V
Operation Temperature	-55 ~ +155°C			
Basic Specification	JIS C5201-1 / IEC 60115-1			
Circuit Mode: R1=R2(=R3=R4)				

Note :
Power derating curve and detail specification please refer to specific data sheets.

WA06W Chip Resistors Array 16P8R

Description

The resistors array is constructed in a high grade ceramic body (aluminum oxide). Internal metal electrodes are added at each end and connected by a resistive paste that is applied to the top surface of the substrate. The composition of the paste is adjusted to give the approximate resistance required and the value is trimmed to within tolerance by laser cutting of this resistive layer.

The resistors layer is covered with a protective coat. Finally, the two external end terminations are added. For ease of soldering the outer layer of these end termination is Tin (Pb free) solder alloy.

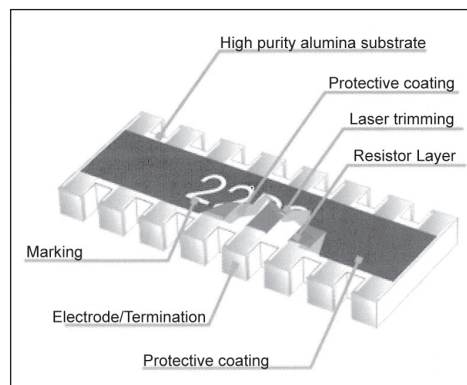

Quick Reference Data

Item	General Specification	
Series No.	WA06W	WA06W_N
Size	1606 (0602×8)	1606 (0602×8)
Termination construction	Convex type	Convex type
Resistance Tolerance	±5% (E24 series)	±5% (E24 series)
Resistance Range	10Ω~100KΩ, Jumper (0Ω)	10Ω~100KΩ, Jumper (0Ω)
TCR (ppm/°C)	± 200 ppm/°C	± 200 ppm/°C
Max. dissipation @ Tamb=70°C	1/16 W	1/16 W
Max. Operation Voltage (DC or RMS)	50V	25V
Max. Overload Voltage (DC or RMS)	100V	50V
Carrier Tape width	12mm	8mm
Operation Temperature	-55 ~ +155°C	
Circuit Mode: R1=R2=R3=R4=R5=R6=R7=R8		

Note :
Power derating curve and detail specification please refer to specific data sheets.

Physical Dimensions:

Unit: mm

Symbol	WA06W	WA06W_N
L	4.00±0.20	3.80±0.10
W	1.60±0.15	1.60±0.10
T	0.45±0.10	0.45±0.10
B	0.30±0.20	0.30±0.10
G	0.30±0.20	0.30±0.10
D	0.20±0.10	0.20±0.10
P	0.50±0.20	0.50±0.10
H1	0.40±0.20	0.30±0.10
H2	0.30±0.10	0.30±0.10

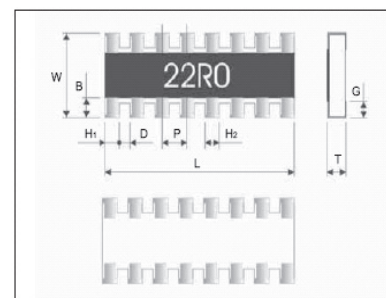

Chip Resistors Array : Concave Termination

Feature

1. High reliability and stability
2. Reduced size of final equipment
3. Lower assembly cost and higher surface mounted efficiency
4. Higher component and equipment reliability
5. Strong body and terminations
6. Excellent performance in surface mounting assembly.

Application

1. Consumer electrical equipment, PDA Digital Camcorder,
2. EDP, Computer application
3. Mobile phone, Telecom
4. DIMM

Description and Physical Dimensions

The resistor array is constructed in a high grade ceramic body (aluminum oxide). Internal metal electrodes are added at each end and connected by a resistive paste that is applied to the top surface of the substrate. The composition of the paste is adjusted to give the approximate resistance required and the value is trimmed to within tolerance by laser cutting of this resistive layer.

The resistive layer is covered with a protective coat. Finally, the two external end terminations are added. For ease of soldering the outer layer of these end termination is Tin solder alloy. Marking code description is depended on component size and tolerance. Following figure shown the construction of a Chip-R array.

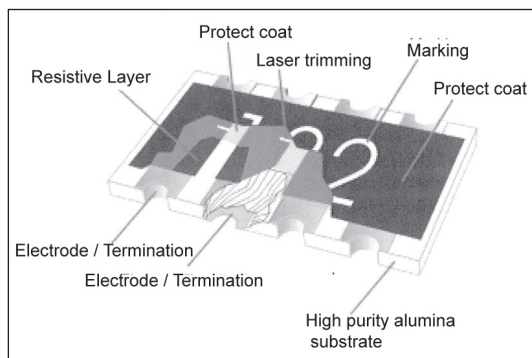

Quick Reference Data

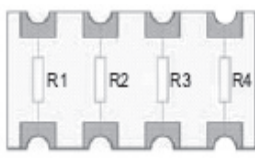
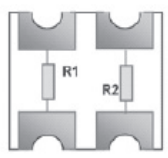
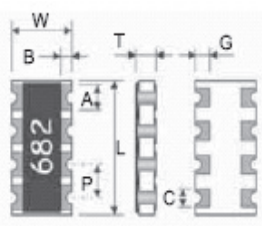
Item	General Specification			
Series No.	WA06T	WA04T	WA04U	
Size	0603×4 (1608×4)	0402×4 (1005×4)	0402×2 (1005×2)	
Termination construction	Concave type			
Resistance Tolerance	±5% , ±1% (E24 series)			
Resistance Range	10Ω~1MΩ, Jumper (0Ω)			
TCR (ppm/°C)	± 200 ppm/°C	± 300 ppm/°C	± 300 ppm/°C	
Max. dissipation @ Tamb=70°C	1/10 W	1/16 W	1/16 W	
Max. Operation Voltage (DC or RMS)	50V	25V	25V	
Max. Overload Voltage	100V	50V	50V	
Operation Temperature	-55 ~ +155°C			
Circuit Mode	 <p>R1=R2=R3=R4</p>		 <p>R1 = R2</p>	
	L	3.20+0.20/-0.10mm	2.00±0.10mm	1.00±0.10mm
	W	1.60+0.20/-0.10mm	1.00±0.10mm	1.00±0.10mm
	T	0.60±0.20mm	0.45±0.10mm	0.30±0.10mm
	P	0.80±0.10mm	0.50±0.05mm	0.50±0.05mm
	A	0.60±0.15mm	0.35±0.05mm	0.35±0.10mm
	B	0.35±0.15mm	0.20±0.15mm	0.25±0.15mm
	C	0.50±0.15mm	0.25±0.05mm	0.35±0.10mm
	G	0.50±0.15mm	0.25±0.15mm	0.25±0.15mm

Note :

1. Power derating curve and detail specification please refer to specific data sheets.
2. Max. Operation Voltage : So called RCWW (Rated Continuous Working Voltage) is determined by $RCWW = \sqrt{\text{Rater Power} \times \text{Resistance Value}}$ or Max. RCWW listed above, whichever is lower.

WT04X Chip Resistor Network 10P8R

Description

The resistor array is constructed in a high grade ceramic body (aluminum oxide). Internal metal electrodes are added at each end and connected by a resistive paste that is applied to the top surface of the substrate. The composition of the paste is adjusted to give the approximate resistance required and the value is trimmed to within tolerance by laser cutting of this resistive layer.

The resistive layer is covered with a protective coat. Finally, the two external end terminations are added. For ease of soldering the outer layer of these end termination is Tin (Pb free) solder alloy.

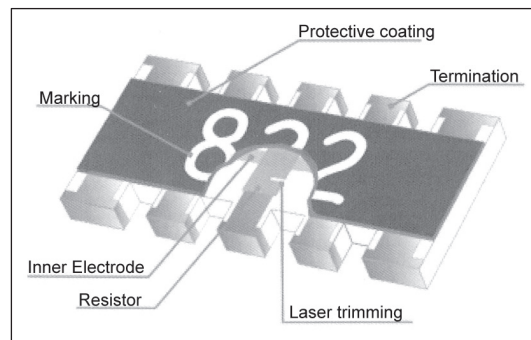

Quick Reference Data

Item	General Specification
Series No.	WT04X
Size	0402x8 (1005x8)
Termination construction	Convex type
Resistance Tolerance	±5% (E24 series)
Resistance Range	10Ω ~ 100KΩ
TCR (ppm/°C)	± 200 ppm/°C
Max. dissipation @ Tamb=70°C	1/16 W
Max. Operation Voltage (DC or RMS)	25V
Max. Overload Voltage (DC or RMS)	50V
Operation Temperature	-55 ~ +155°C
Circuit Mode: Resistor elements on pin1 ~ pin4, pin6 ~ pin9; R1=R2=R3=R4=R6=R7=R8=R9	

Note :

1. Power derating curve and detail specification please refer to specific data sheets.

Physical Dimensions:

Unit: mm

Symbol	
L	3.30±0.20
W	1.60±0.15
T	0.55±0.10
P	0.64±0.05
A	0.50±0.05
B	0.40±0.15
C	0.40±0.15
G	0.40±0.15

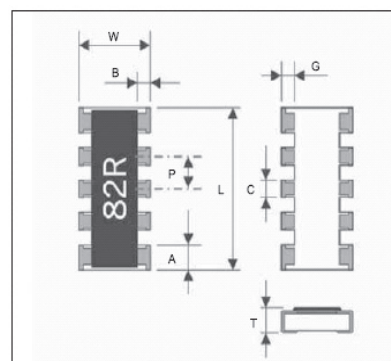

WA04P Chip Attenuator

Typical Application of Chip Attenuator

WA04	P	001	X	B	T	L
Size code	Type code	Attenuation Range	Characteristic Impedance	Attenuation Tolerance	Termination	Packaging
WA04: 0402 per element	P: convex, π type attenuator	000 = 0dB R05 = 0.5dB 001 = 1dB R15 = 1.5dB 002 = 2dB 003 = 3dB 004 = 4dB 005 = 5dB 006 = 6dB 007 = 7dB 008 = 8dB 009 = 9dB 010 = 10dB 011 = 11dB 012 = 12dB 013 = 13dB 014 = 14dB 015 = 15dB 016 = 16dB 017 = 17dB 018 = 18dB 019 = 19dB 020 = 20dB	X:50 Ω	A: ± 0.1 dB B: ± 0.3 dB C: ± 0.4 dB D: ± 0.8 dB E: ± 1.0 dB F: ± 1.5 dB G: ± 2.0 dB H: ± 2.5 dB P: -	T=7" reel taped	L=Sn base (lead free)

π type Attenuator (-6dB, 50W) for VSWR improvement and output frequency level matching on VCO application.

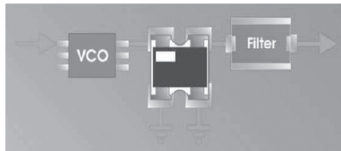

Quick Reference Data

Item	General Specification
Series No.	WA04P
Size	0402x2 (1005x2)
Termination construction	Convex type
Attenuation Range	0dB, 0.5dB ~ 20dB
Attenuation Tolerance	
0dB	-
0.5dB	± 0.1 dB
1dB~ 5dB	± 0.3 dB
6dB~ 10dB	± 0.4 dB
11dB~ 13dB	± 0.8 dB
14dB	± 1.0 dB
15dB~ 16dB	± 1.5 dB
17dB~ 19dB	± 2.0 dB
20dB	± 2.5 dB
Characteristic impedance	50 Ω
Rated power at Tamb=70°C	0.1 W / package
Limiting Voltage (DC)	50V
Frequency range (DC)	MAX. 3 GHz
VSWR (Voltage Standing Wave Ratio)	MAX. 1.2
Number of Resistors	3 resistors
Number of Terminals	4 terminals
Operation Temperature	-40 ~ 125°C

Physical Dimensions:

Unit: mm	WA04P
L	1.00 \pm 0.10
W	1.00+0.10/-0
T	0.35 \pm 0.10
P	0.65 \pm 0.20
A	0.33 \pm 0.10
Ta	0.15 \pm 0.10
Tb	0.25 \pm 0.10

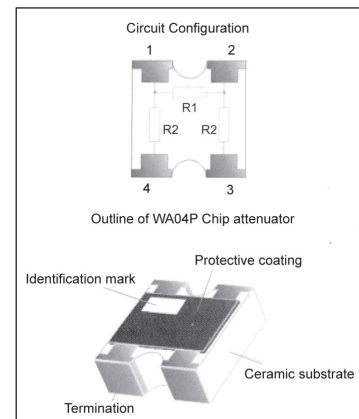
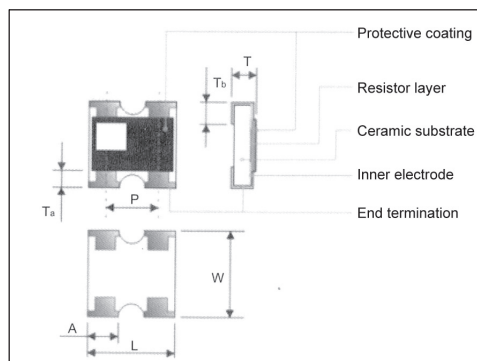

Special Application Chip Resistors

Feature

1. Provided Automotive & Anti-sulfuration resistors (MR/SR series) for Auto & Anti-sulfuration application.
2. Provided Total Lead Free resistors (WR_R series) to fulfill RoHS environmental regulation.
3. Provided trimmable resistors (WKxxM series) for customer special tolerance requirement.
4. Provided high precision tolerance (WFxxH/ WFxxT/ WFxxU/ WFxxW) down to $\pm 0.05\%$ and TCR down to $10\text{ppm}/^\circ\text{C}$ for voltage sensing application.
5. High reliability and stability.
6. Reduced size of final equipment
7. Lower assembly costs.
8. Higher component and equipment reliability
9. Special resistance, tolerance are available upon customer's request.

MR/SR Series of Automotive & Anti-sulfuration Chip Resistor

Feature

1. High reliability and stability $\pm 1\%$.
2. Sulfuration resistant
3. Automotive grade AEC Q-200 compliant.
4. 100% CCD inspection.
5. RoHS compliant and lead free.

Application

1. Automotive application.
2. Consumer electrical equipment.
3. EDP, Computer application.
4. Telecom Application.

Quick Reference Data

Series No.	MR12X	MR08X	MR06X	MR04X
Size code	1206(3126)	0805(2012)	0603(1608)	0402(1005)
Resistance Range	1 Ω ~10M Ω ($\pm 1\%$, $\pm 5\%$) ,Jumper			
TCR (ppm/ $^\circ\text{C}$)	± 200 ppm*			
Max. dissipation @ Tamb=70 $^\circ\text{C}$	1/4 W	1/8 W	1/10 W	1/16 W
Max. Operation Voltage (DC or RMS)	200V	150V	75V	50V
Operation Temperature	-55 ~ +155 $^\circ\text{C}$			

Series No.	SR12X	SR08X	SR06X	SR04X
Size code	1206(3126)	0805(2012)	0603(1608)	0402(1005)
Resistance Range	1 Ω ~10M Ω ($\pm 1\%$, $\pm 5\%$) ,Jumper			
TCR (ppm/ $^\circ\text{C}$)	± 200 ppm*			
Max. dissipation @ Tamb=70 $^\circ\text{C}$	1/4 W	1/8 W	1/10 W	1/16 W
Max. Operation Voltage (DC or RMS)	200V	150V	75V	50V
Operation Temperature	-55 ~ +155 $^\circ\text{C}$			

Remark: *Detail specification please refer to specific data sheets!

*MR series can withstand H2S 3ppm \times 1000hrs.

*SR series can withstand H2S 1000ppm \times 720hrs.

WR_R Series of Total Lead Free Chip Resistors

Feature

1. High reliability and stability
2. Reduced size of final equipment
3. Lower assembly cost
4. Higher component and equipment reliability
5. RoHS compliant and total lead free

Quick Reference Data

Series No.	WR12_R	WR12_R	WR08_R	WR06_R	WR04_R	WR02_R
Size code	1210(3225)	1206(3126)	0805(2012)	0603(1608)	0402(1005)	0201(0603)
Resistance Range	1 Ω ~10M Ω ($\pm 1\%$, $\pm 5\%$) ,Jumper					
TCR (ppm/ $^\circ\text{C}$)	± 200 ppm*					
Max. dissipation @ Tamb=70 $^\circ\text{C}$	1/3 W	1/4 W	1/8 W	1/10 W	1/16 W	1/20 W
Max. Operation Voltage (DC or RMS)	200V	200V	150V	50V	50V	25V
Operation Temperature	-55 ~ +155 $^\circ\text{C}$					-55 ~ +125 $^\circ\text{C}$

Remark: *Detail specification please refer to specific data sheets!

Part No. Definition

1 st code	2 nd code	3 rd ~4 th code	5 th code	6 th ~9 th code	10 th code	11 th code	12 th code
□	□	□□	□	□□□□	□	□	R
WTC	Type code	Size code	Functional code	Marking code (Resistance)	Tolerance code	Packaging code	Termination code
For example:							
W	R	04	X	1000	F	T	R

WKxxM Series of Trimmable Chip Resistors

Feature

1. High precision, reliability and stability
2. Miniature size down to 00603 (1608)

Description

The resistors are constructed on a high grade ceramic body (aluminum oxide). Internal metal electrodes are added at each end and connected by a resistive paste that is applied to the top surface of the substrate. The composition of the paste is adjusted to give the approximate resistance required.

The resistive layer is covered with a transparent protective coat. Finally, the two external end terminations are added. For ease of soldering the outer layer of these end termination is Tin (Pb free) solder alloy.

Application

1. Automotive application.
2. Consumer electrical equipment.
3. EDP, Computer application.
4. Telecom Application.

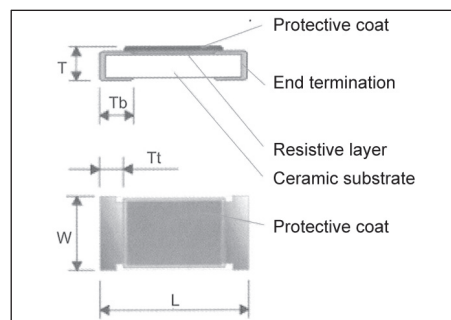
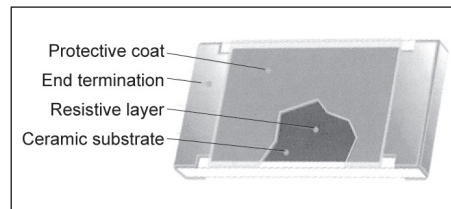

Physical Dimensions

Unit: mm

Type	WK25M	WK20M	WK10M	WK12M	WK08M	WK06M
L	6.30±0.15	5.00±0.15	3.10±0.15	3.10±0.15	2.00±0.10	1.60±0.10
W	3.20±0.15	2.50±0.15	2.50±0.15	1.60±0.15	1.25±0.10	0.80+0.15/-0.10
T	0.55±0.15	0.55±0.15	0.55±0.15	0.55±0.10	0.55±0.10	0.45±0.10
Tb	0.60±0.20	0.60±0.20	0.50±0.25	0.50±0.25	0.40±0.20	0.30±0.10
Tt	0.60±0.20	0.60±0.20	0.50±0.25	0.50±0.25	0.40±0.20	0.30±0.10

Quick Reference Data

Series No.	WK25M	WK20M	WK10M	WK12M	WK08M	WK06M
Size code	2512 (6332)	2010 (5025)	1210(3225)	1206(3216)	0805(2012)	0603(1608)
Resistance Tolerance	0/-20%(Y) and 0/-30%(X) E24 series					
Resistance Range	1Ω ~ 4.7MΩ					10Ω ~ 4.7MΩ
TCR (ppm/°C)	10Ω ~ 4.7MΩ: ±200 ppm/°C 1Ω ~ 9.1Ω: -200 ~ +500 ppm/°C					±200 ppm/°C
Max. dissipation @ Tamb=70°C	1 W	1/2 W	1/4 W	1/8 W	1/10 W	1/16 W
Max. Operation Voltage (DC or RMS)	200V	200V	200V	200V	150V	50V
Operation Temperature	-55 ~ +125°C					
Basic Specification	JIS C 5201-1 / IEC 60115-1					

WKxxV Series of High Voltage Chip Resistors

Feature

1. Special material and design for high working voltage required
2. Compatible with flow and reflow soldering.
3. Suitable for lead free soldering.

Application

1. Power supply.
2. Automotive industry.
3. Measurement instrument.
4. Back light inverter.
5. Medical or Military equipment

Quick Reference Data

Series No.	WK25V	WK20V	WK12V	WK08V	WK06V
Size code	2512 (6332)	2010 (5025)	1206(3216)	0805(2012)	0603(1608)
Resistance Tolerance	±5% ; ±1%				
Resistance Range	47Ω ~ 51MΩ				47Ω ~ 10MΩ
TCR (ppm/°C)	± 200 ppm/°C * detail refer to data sheet				
Max. dissipation @ Tamb=70°C	1 W	1/2 W	1/4 W	1/8 W	1/10 W
Max. Operation Voltage (DC or RMS)	800V	500V	500V	400V	200V
Operation Temperature	-55 ~ +125°C				

Note :

1. This is the maximum voltage that may be continuously supplied to the resistor element, see "IEC publication 60115-8".
2. Max. Operation Voltage : So called RCWW (Rated Continuous Working Voltage) is determined by $RCWW = \sqrt{\text{Rater Power} \times \text{Resistance Value}}$ or Max. RCWW listed above, whichever is lower.

Physical Dimensions

Unit: mm

Symbol	WK25V	WK20V	WK12V	WK08V	WK06V
L	6.30±0.15	5.00±0.15	3.10±0.15	2.00±0.10	1.60±0.10
W	3.20±0.15	2.50±0.15	1.60±0.15	1.25±0.10	0.80+0.15/-0.10
T	0.55±0.15	0.55±0.15	0.55±0.10	0.55±0.10	0.45±0.10
Tt	0.60±0.20	0.60±0.20	0.50±0.25	0.40±0.20	0.30±0.10
Tb	0.60±0.20	0.60±0.20	0.50±0.25	0.40±0.20	0.30±0.10

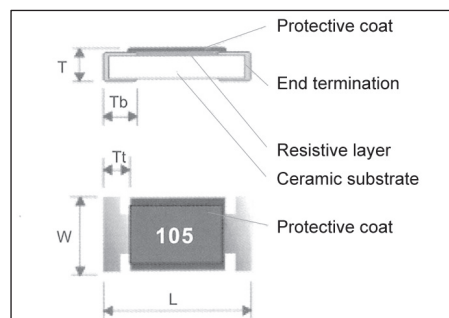

WFxxP Series of High Power Chip Resistors

Feature

1. High power rating and compact size
2. High reliability and stability
3. Reduced size of final equipment
4. Lead free product is upon customer requested

Application

1. Power supply
2. PDA
3. Digital meter
4. Computer
5. Automotives.

Quick Reference Data

Item	General Specification						
Series No.	WF25P	WF20P	WF10P	WF12P	WF08P	WF06P	WF04P
Size code	2512(6432)	2010(5025)	1210(3225)	1206(3216)	0805(2012)	0603 (1608)	0402(1005)
Resistance Tolerance	±1% , ±5%						
Resistance Range	0Ω, 1Ω ~ 1MΩ						
TCR (ppm/°C)	± 100 ppm/°C						
Max. dissipation @ Tamb=70°C	2W	1W	1/2W	1/2W	1/4W	1/8W	1/8W
Max. Operation Voltage (DC or RMS)	300V	200V	200V	200V	150V	50V	50V
Operation Temperature	-55 ~ +155°C						

Note :

1. This is the maximum voltage that may be continuously supplied to the resistor element, see "IEC publication 60115-8".
2. Max. Operation Voltage : So called RCWW (Rated Continuous Working Voltage) is determined by
 $RCWW = \sqrt{\text{Rater Power} \times \text{Resistance Value}}$ or Max. RCWW listed above, whichever is lower.
3. 2W loading with total solder-pad and trace size of 300mm²
4. 0Ω maximum resistance Rmax < 15mΩ and rated current < 4Amp

Physical Dimensions

Unit: mm

Symbol	WF25P	WF20P	WF10P	WF12P	WF08P	WF06P	WF04P
L	6.30±0.20	5.00±0.20	3.10±0.10	3.10±0.15	2.00±0.15	1.60±0.10	1.00±0.05
W	3.10±0.20	2.50±0.20	2.60±0.10	1.60±0.15	1.20±0.15	0.80±0.10	0.50±0.05
T	0.60±0.15	0.60±0.10	0.55±0.10	0.55±0.10	0.50±0.10	0.45±0.10	0.35±0.05
Tt	0.60±0.25	0.60±0.25	0.50±0.20	0.50±0.25	0.40±0.20	0.30±0.20	0.25±0.10
Tb	1.80±0.25	0.60±0.25	0.50±0.20	0.50±0.25	0.40±0.20	0.30±0.20	0.25±0.10

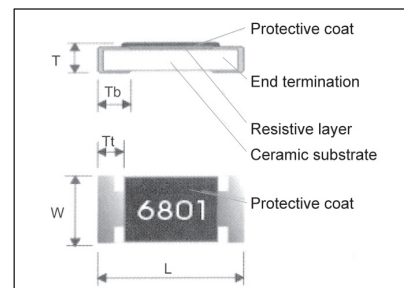

WKxxS Series of Anti-Surge Chip Resistors

Feature

1. Power rating and compact size
2. High reliability and stability
3. Reduced size of final equipment
4. Surge protection

Application

1. Power supply.
2. Measurement instrument.
3. Automotive industry.
4. Medical or Military equipment.

Quick Reference Data

Item	General Specification				
Series No.	WK25S	WK20S	WK10S	WK12S	WK08S
Size code	2512(6432)	2010(5025)	1210(3225)	1206(3216)	0805(2012)
Resistance Tolerance	±5% , ±10% , ±20% , (E24)				
Resistance Range	0.27Ω ~ 22MΩ				
TCR (ppm/°C)	± 200 ppm/°C				
Max. dissipation @ Tamb=70°C	1 W	3/4W	1/2W	1/4W	1/8W
Max. Operation Voltage (DC or RMS)	200V				150V
Operation Temperature	-55 ~ +155°C				

Note :

1. This is the maximum voltage that may be continuously supplied to the resistor element, see "IEC publication 60115-8".
2. Max. Operation Voltage : So called RCWW (Rated Continuous Working Voltage) is determined by
 $RCWW = \sqrt{\text{Rater Power} \times \text{Resistance Value}}$ or Max. RCWW listed above, whichever is lower.

Physical Dimensions

Unit: mm

Symbol	WK25S	WK20S	WK10S	WK12S	WK08S
L	6.30±0.15	5.00±0.15	3.20±0.15	3.20±0.15	2.00±0.10
W	3.20±0.15	2.50±0.15	2.50±0.15	1.60±0.15	1.25±0.10
T	0.55±0.15	0.55±0.15	0.55±0.15	0.55±0.10	0.55±0.10
Tt	0.30±0.15	0.30±0.15	0.30±0.20	0.30±0.20	0.30±0.20
Tb	0.60±0.20	0.60±0.20	0.50±0.25	0.50±0.25	0.40±0.20

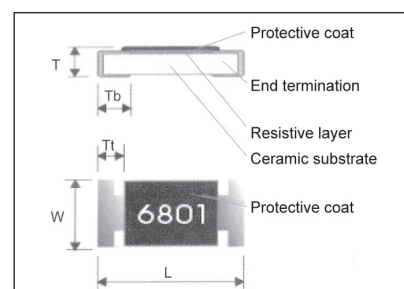
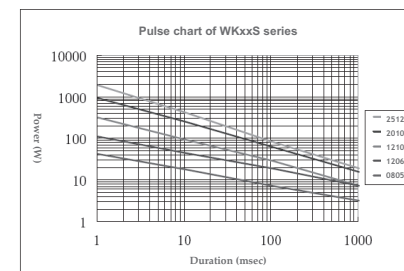

High Precision Chip Resistors

Narrow Tolerance Thick Film TC100 WFxxH Series

Series No.	WF12H	WF08H	WF06H	WF04H
Size	1206(3216)	0805(2012)	0603(1608)	0402(1005)
Resistance Tolerance	±0.5% , ±0.1%			
Resistance Range	10Ω ~ 1MΩ (E96+E24 series)			
TCR (ppm/°C)	±100 ppm/°C			
Max. dissipation @ Tamb=70°C	1/4 W	1/8 W	1/10 W	1/16 W
Max. Operation Voltage (DC or RMS)	200V	100V	50V	50V
Operation Temperature	-55 ~ +155°C			
Basic Specification	JIS C5201-1 / IEC 60115-1			

(Detail specification please refer to specific data sheets)

Narrow Tolerance Thin Film TC50 WFxxT/ WFxxQ Series

Series No.	WF25T	WF25Q	WF20T	WF20Q	WF10T	WF10Q	WF12T	WF12Q	WF08T	WF08Q	WF06T	WF06Q	WF04T
Size	2512 (6432)	2512 (6432)	2010 (5025)	2010 (5025)	1210 (3225)	1210 (3225)	1206 (3216)	1206 (3216)	0805 (2012)	0805 (2012)	0603 (1608)	0603 (1608)	0402 (1005)
Resistance Tolerance	±1%, ±0.5% , ±0.1%, ±0.05%												
Resistance Range	10 ~ 1.5MΩ				10 ~ 1MΩ		4.7 ~ 1MΩ			4.7 ~ 680KΩ		10 ~ 100KΩ	
TCR (ppm/°C)	±50 ppm/°C												
Max. dissipation @ Tamb=70°C	3/4W	1W	1/2W	3/4W	1/4W	2/5W	1/8W	1/4W	1/10W	1/8W	1/16W	1/10W	1/16W
Max. Operation Voltage (DC or RMS)	200V	200V	200V	200V	200V	200V	200V	200V	100V	150V	50V	75V	25V
Operation Temperature	-55 ~ +155°C												
Basic Specification	JIS C5201-1 / IEC 60115-1												

(Detail specification please refer to specific data sheets)

Narrow Tolerance Thin Film TC25 WFxxU/ WFxxR Series

Series No.	WF25U	WF25R	WF20U	WF20R	WF10U	WF10R	WF12U	WF12R	WF08U	WF08R	WF06U	WF06R	WF04U
Size	2512 (6432)	2512 (6432)	2010 (5025)	2010 (5025)	1210 (3225)	1210 (3225)	1206 (3216)	1206 (3216)	0805 (2012)	0805 (2012)	0603 (1608)	0603 (1608)	0402 (1005)
Resistance Tolerance	±1%, ±0.5% , ±0.1%, ±0.05%												
Resistance Range	10 ~ 1.5MΩ				10 ~ 1MΩ		4.7 ~ 1MΩ			4.7 ~ 680KΩ		10 ~ 100KΩ	
TCR (ppm/°C)	±25 ppm/°C												
Max. dissipation @ Tamb=70°C	3/4W	1W	1/2W	3/4W	1/4W	2/5W	1/8W	1/4W	1/10W	1/8W	1/16W	1/10W	1/16W
Max. Operation Voltage (DC or RMS)	200V	200V	200V	200V	200V	200V	200V	200V	100V	150V	50V	75V	25V
Operation Temperature	-55 ~ +155°C												
Basic Specification	JIS C5201-1 / IEC 60115-1												

(Detail specification please refer to specific data sheets)

Narrow Tolerance Thin Film TC15 WFxxF Series

Series No.	WF12F	WF08F	WF06F	WF04F
Size	1206 (3216)	0805 (2012)	0603 (1608)	0402 (1005)
Resistance Tolerance	±0.5% , ±0.1% , ±0.05%			
Resistance Range	25 ~ 300KΩ	25 ~ 200KΩ	25 ~ 100KΩ	25 ~ 20KΩ
TCR (ppm/°C)	± 15 ppm/°C			
Max. dissipation @ Tamb=70°C	1/8W	1/8W	1/10W	1/16W
Max. Operation Voltage (DC or RMS)	150V	100V	50V	25V
Operation Temperature	-55 ~ +155°C			
Basic Specification	JIS C5201-1 / IEC 60115-1			

(Detail specification please refer to specific data sheets) * Sample is available upon request

Narrow Tolerance Thin Film TC10 WFxxW Series

Series No.	WF12W	WF08W	WF06W	WF04W
Size	1206(3216)	0805(2012)	0603(1608)	0402(1005)
Resistance Tolerance	±0.5% , ±0.1% , ±0.05%			
Resistance Range	25 ~ 300KΩ	25 ~ 200KΩ	25 ~ 100KΩ	25 ~ 20KΩ
TCR (ppm/°C)	± 10 ppm/°C			
Max. dissipation @ Tamb=70°C	1/8W	1/8W	1/10W	1/16W
Max. Operation Voltage (DC or RMS)	150V	100V	50V	25V
Operation Temperature	-55 ~ +155°C			
Basic Specification	JIS C5201-1 / IEC 60115-1			

(Detail specification please refer to specific data sheets)

Narrow Tolerance Thin Film TC5 WFxxZ Series

Series No.	WF12Z	WF08Z	WF06Z	WF04Z
Size	1206(3216)	0805(2012)	0603(1608)	0402(1005)
Resistance Tolerance	±0.5% , ±0.1% , ±0.05%			
Resistance Range	25 ~ 120KΩ	25 ~ 80KΩ	25 ~ 40KΩ	25 ~ 8KΩ
TCR (ppm/°C)	±5 ppm/°C			
Max. dissipation @ Tamb=70°C	1/8W	1/8W	1/10W	1/16W
Max. Operation Voltage (DC or RMS)	150V	100V	50V	25V
Operation Temperature	-55 ~ +155°C			
Basic Specification	JIS C5201-1 / IEC 60115-1			

(Detail specification please refer to specific data sheets)

Test and Requirements

For WR Series

Test	Procedure / Test Method	Requirements	
		Resistor	0Ω
Electrical Characteristics JISC5201-1: 1998 Clause 4.8	- DC resistance values measurement - Temperature Coefficient of Resistance (T.C.R) Natural resistance change per change in degree centigrade. $[(R2-R1)/R1(T2-T1)] \times 10^6$ (ppm /°C) T1:20°C+5°C-1°C R1:Resistance at reference temperature (20°C+5°C/-1°C) R2:Resistance at test temperature (-55°C or +155°C)	Within the specified tolerance Refer to "QUICK REFERENCE DATA"	< 50mΩ
Resistance to soldering heat(R.S.H) JISC5201-1:1998 Clause 4.18	Un-mounted chips completely immersed for 10±1second in a SAC solder bath at 260°C±5°C	±5%: $\Delta R/R_{max}$. (1%+0.05Ω) ±1%: $\Delta R/R_{max}$. (0.5%+0.05Ω) no visible damage	< 50mΩ
Solder ability JISC5201-1:1998 Clause 4.17	Un-mounted chips completely immersed for 2±0.5 second in a SAC solder bath at 235°C±5°C	95% coverage min., good tinning and no visible damage	
Temperature cycling JISC5201-1:1998 Clause 4.19	30minutes at -55°C±3°C, 2~3minutes at 20°C+5°C-1°C,30minutes at +155°C±3°C,2~3minutes at 20°C+5°C-1°C,total 5continuous cycles	±5%: $\Delta R/R_{max}$. (1%+0.05Ω) ±1%: $\Delta R/R_{max}$. (0.5%+0.05Ω) no visible damage	< 50mΩ
High Temperature Exposure MIL-STD-202 Mothod 108	1000+48/-0 hours; without load in a temperature chamber controlled 155°C±3°C	±5%: $\Delta R/R_{max}$. (2%+0.1Ω) ±1%: $\Delta R/R_{max}$. (1%+0.1Ω) no visible damage	< 50mΩ
Bending strength JISC5201-1:1998 Clause 4.33	Resistors mounted on a 90mm glass epoxy resin PCB(FR-4), bending once 3mm for 10sec, 5mm for WR04	±5%: $\Delta R/R_{max}$. (1%+0.05Ω) ±1%: $\Delta R/R_{max}$. (1%+0.05Ω) no visible damage	< 50mΩ
Adhesion JISC5201-1:1998 Clause 4.32	Pressurizing force: 5N, Test time: 10±1sec.	No remarkable damage or removal of the terminations	
Short Time Overload (STOL) JISC5201-1:1998 Clause 4.13	2.5 times RCWV or max. overload voltage, for 5seconds	±5%: $\Delta R/R_{max}$. (2%+0.1Ω) ±1%: $\Delta R/R_{max}$. (1%+0.1Ω) no visible damage	< 50mΩ
Load life in Humidity JISC5201-1:1998 Clause 4.24	1000+48/-0 hours, loaded with RCWV or Vmax in humidity chamber controller 40°C±2°C at and 90~95% relative humidity, 1.5 hours on and 0.5 hours off	±5%: $\Delta R/R_{max}$. (2%+0.1Ω) ±1%: $\Delta R/R_{max}$. (1%+0.1Ω) no visible damage	< 50mΩ
Load life (endurance) JISC5201-1:1998 Clause 4.25	1000+48/-0 hours, loaded with RCWV or Vmax in chamber controller 70°C±2°C 1.5 hours on and 0.5 hours off	±5%: $\Delta R/R_{max}$. (2%+0.1Ω) ±1%: $\Delta R/R_{max}$. (1%+0.1Ω) no visible damage	< 50mΩ
Insulation Resistance JISC5201-1:1998 Clause 4.6	Apply the maximum overload voltage (DC) for 1minute	$R \geq 10G\Omega$	
Dielectric Withstand Voltage JISC5201-1:1998 Clause 4.7	Apply the maximum overload voltage (AC) for 1minute	No breakdown or flashover	

■ For WW Series

Test	Procedure / Test Method	Requirements
		Resistor
Electrical Characteristics JISC5201-1: 1998 Clause 4.8	- DC resistance values measurement - Temperature Coefficient of Resistance (T.C.R) Natural resistance change per change in degree centigrade. $[(R2-R1)/R1(T2-T1)] \times 10^6$ (ppm/°C) T1:20°C+5°C-1°C R1:Resistance at reference temperature (20°C+5°C/-1°C) R2:Resistance at test temperature (-55°C or +155°C)	Within the specified tolerance Refer to "QUICK REFERENCE DATA"
Resistance to soldering heat(R.S.H) JISC5201-1:1998 Clause 4.18	Un-mounted chips completely immersed for 10±1second in a SAC solder bath at 260°C±5°C	ΔR/R max. ±(1%+0.005Ω) no visible damage
Solder ability JISC5201-1:1998 Clause 4.17	Un-mounted chips completely immersed for 2±0.5 second in a SAC solder bath at 235°C±5°C	95% coverage min., good tinning and no visible damage
Temperature cycling JISC5201-1:1998 Clause 4.19	30minutes at -55°C±3°C, 2~3minutes at 20°C+5°C-1°C,30minutes at +155°C±3°C,2~3minutes at 20°C+5°C-1°C,total 5continuous cycles	ΔR/R max. ±(1%+0.005Ω) no visible damage
High Temperature Exposure MIL-STD-202 Method 108	1000+48/-0 hours; without load in a temperature chamber controlled 155°C±3°C	ΔR/R max. ±(3%+0.005Ω) no visible damage
Bending strength JISC5201-1:1998 Clause 4.33	Resistors mounted on a 90mm glass epoxy resin PCB(FR-4), bending once 3mm for 10sec, 5mm for WR04	ΔR/R max. ±(1%+0.005Ω) no visible damage
Adhesion JISC5201-1:1998 Clause 4.32	Pressurizing force: 5N, Test time: 10±1sec.	No remarkable damage or removal of the terminations
Short Time Overload (STOL) JISC5201-1:1998 Clause 4.13	2.5 times RCWV or max. overload voltage, for 5 seconds	ΔR/R max. ±(2%+0.005Ω) no visible damage
Load life in Humidity JISC5201-1:1998 Clause 4.24	1000+48/-0 hours, loaded with RCWV or Vmax in humidity chamber controller 40°C±2°C at and 90~95% relative humidity, 1.5 hours on and 0.5 hours off	ΔR/R max. ±(3%+0.005Ω) no visible damage
Load life (endurance) JISC5201-1:1998 Clause 4.25	1000+48/-0 hours, loaded with RCWV or Vmax in chamber controller 70°C±2°C 1.5 hours on and 0.5 hours off	ΔR/R max. ±(3%+0.005Ω) no visible damage
Insulation Resistance JISC5201-1:1998 Clause 4.6	Apply the maximum overload voltage (DC) for 1minute	$R \geq 10G\Omega$
Dielectric Withstand Voltage JISC5201-1:1998 Clause 4.7	Apply the maximum overload voltage (AC) for 1minute	No breakdown or flashover

■ Packing on Tape and Reel: All specifications are in accordance with IEC 60286-3 !

■ Paper Tape Specifications for WR,WF,WW Series and WA,WT Series

Unit: mm

Component Size / Series	W	F	E	PO	ΦD
1206, 0805, 0603, 0402, WA06X, WA06T, WA04X, WA04Y, WA04P, WA04T, WA04U, WT04X	8.00±0.30	3.50±0.20	1.75±0.10	4.00±0.10	Φ1.50±0.1
WA06W	12.0±0.10	5.50±0.05			
WR02X	8.00±0.20	3.50±0.05			

Component Size / Series	A	B	P1	T
1206(3216), WA06X, WA06T	3.60±0.20	2.00±0.20	4.00±0.10	Max. 1.0
0805(2012)	2.40±0.20	1.65±0.20		0.65±0.05
0603(1608)	1.90±0.20	1.10±0.20		
0402(1005)	1.20±0.10	0.70±0.10	2.00±0.10	0.40±0.05
WA04X, WA04T	2.20±0.20	1.20±0.20	2.00±0.05	Max. 0.6
WA04Y, WA04P, WA04U	1.15±0.10	1.15±0.10	2.00±0.05	0.45±0.05
WT04X	3.45+0.2/-0	1.85+0.2/-0	4.00±0.10	0.85±0.05
WA06W	4.20+0.2/-0	1.80+0.2/-0	4.00±0.10	0.65±0.05
WR02X	0.67±0.05	0.37±0.05	2.00±0.05	0.45±0.05

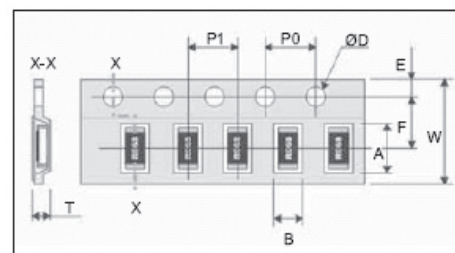
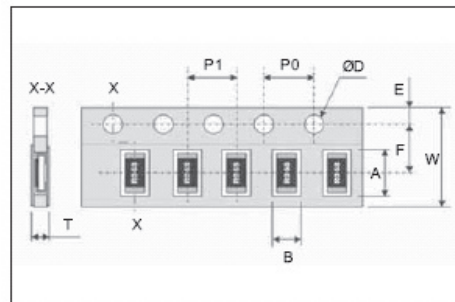

■ Plastic Tape Specifications for WR, WF, WW Series of Chip-R

Unit: mm

Component Size	2512(6432)	2010(5025)	1218(3248)
A	6.90±0.20	5.50±0.20	3.55±0.30
B	3.60±0.20	2.80±0.20	4.90±0.20
W	12.00±0.30		
F	5.50±0.10		
E	1.75±0.10		
P1	4.00±0.10		8.00±0.10
P0	4.00±0.10		
ΦD	Φ1.50±0.1		
T	Max. 1.2		

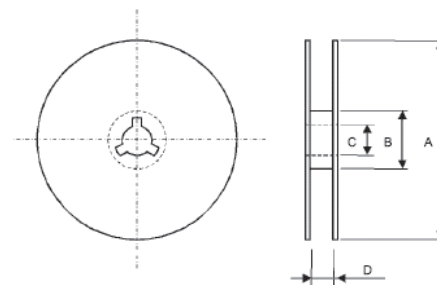

■ Plastic Tape Specifications for WR, WF, WW Series of Chip-R

Unit: mm

Reel/Tape	A	B	C	D
7" reel for 8mm tape	Φ178.0±0.20	Φ60.0±1.00	13.0±0.20	9.00±0.50
7" reel for 12mm tape				12.4±1.00
10" reel for 8mm tape	Φ254.0±2.00	Φ100.0±1.00	13.0±0.20	9.00±0.50
10" reel for 12mm tape	Φ254.0±2.00	Φ100.0±1.00	13.0±0.20	14.0±0.20
13" reel for 8mm tape	Φ330.0±2.00	Φ100.0±1.00	13.0±0.20	9.00±0.50

■ Paper Tape Specifications for WR,WF,WW Series and WA,WT Series

Unit: mm

Component Size / Series	Q'ty per reel	Reel Diameter
0603, 0805, 1206	1,000 pcs	4" reel
1210, 1206, 0805, 0603, WA06X, WA06T, WT04X	5,000 pcs	7" reel
0201,0402, WA04X, WA04Y, WA04P, WA04T, WA04U	10,000 pcs	7" reel
0201, 0402	15,000 pcs	7" reel
WA06X, WA06Y	5,000 pcs	7" reel
2512, 2010	4,000 pcs	7" reel
1218	3,000 pcs	10" reel
1206, 0805, 0603, WA06X, WA06T	10,000 pcs	10" reel
0201, 0402, WA04X, WA04Y	20,000 pcs	10" reel
2010, 2512	8,000 pcs	10" reel
0201	70,000 pcs	13" reel
0402	50,000 pcs/70,000 pcs	13" reel
WA04X, WA04Y	40,000 pcs	13" reel
1206, 0805, 0603, WA06X,	20,000 pcs	13" reel
2010, 2512	16,000 pcs	13" reel

Footprint Design

Footprint Design for WRxx, WFxx, WWxx Series :

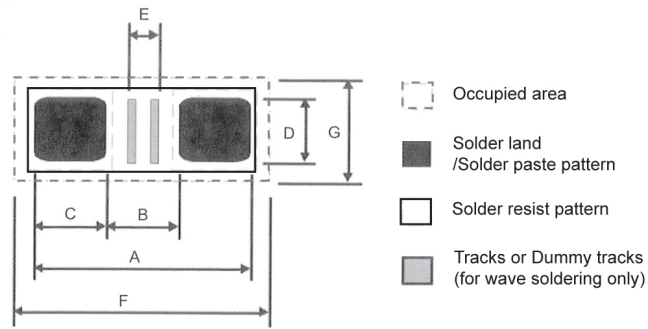

Unit: mm

Size	Reflow Soldering							Processing Remarks	Placement Accuracy
	A	B	C	D	E	F	G		
01005	0.58	0.18	0.20	0.20	0.10	0.90	0.40	IR or hot plate soldering	±0.03
0201	0.75	0.30	0.30	0.30	0.20	1.10	0.50		±0.05
0402	1.50	0.50	0.50	0.60	0.10	1.90	1.00		±0.15
0603	2.10	0.90	0.60	0.90	0.50	2.35	1.45		±0.25
0805	2.60	1.20	0.70	1.30	0.75	2.85	1.90		±0.25
1206	3.80	2.00	0.90	1.60	1.60	4.05	2.25		±0.25
1210	3.80	2.00	0.90	2.80	1.60	4.05	3.15		±0.25
1218	3.80	2.00	0.90	4.80	1.40	4.20	5.50		±0.25
2010	5.60	3.80	0.90	2.80	3.40	5.85	3.15		±0.25
2512	7.00	3.80	1.60	3.50	3.40	7.25	3.85		±0.25

Size	Wave Soldering							Processing Number & Dimensions of dummy tracks	Placement Accuracy
	A	B	C	D	E	F	G		
0603	2.70	0.90	0.90	0.80	0.15	3.40	1.90	1× (0.15 × 0.80)	±0.25
0805	3.40	1.30	1.05	1.30	0.20	4.30	2.70	1× (0.20 × 1.30)	±0.25
1206	4.80	2.30	1.25	1.70	1.25	5.90	3.20	3× (0.25 × 1.70)	±0.25
1210	4.80	2.30	1.25	2.50	1.25	5.90	3.60	3× (0.25 × 1.70)	±0.25
1218	4.80	2.30	1.25	4.80	1.30	5.90	5.60	3× (0.25 × 4.80)	±0.25
2010	6.30	3.50	1.40	2.50	3.00	7.00	3.60	3× (0.75 × 2.50)	±0.25
2512	8.50	4.50	2.00	3.20	3.00	9.00	4.30	3× (1.00 × 3.20)	±0.25

Footprint Design for Array Resistor/Attenuator :

Unit: mm

Symbol	0603*4 array	0402*4 array	WA04Y, WA04P	WA06W	WA02Y	WA02A	WA02B
A	2.85±0.10/-0.05	1.80±0.15/-0.05	1.20±0.05	3.85±0.20/-0.05	1.00±0.05	1.40±0.05	0.80±0.05
B	0.45±0.05	0.30±0.05	0.40 +0/-0.05	0.28 +0/-0.05	0.40 +0/-0.05	0.20 +0/-0.05	0.30 +0/-0.05
D	0.80±0.10	0.50±0.10	0.50±0.05	1.00 +0.1/-0.20	0.30±0.05	0.30±0.05	0.30±0.05
P	0.8	0.5	0.65	0.5	0.5	0.4	0.5
F	3.10±0.30	2.00±0.40/-0.20	1.5 +0.20/-0.10	3.20±0.40	1.00±0.10	0.9±0.10	0.9±0.10

Footprint Design for 10P8R Network Resistor :

Unit: mm

Symbol	WT04X
W1	0.50±0.05
W2	0.35±0.05
H2	0.80±0.10
P1	0.70±0.05
P2	0.65±0.05
A	3.20±0.10
F	2.80 + 0.40 / -0.20

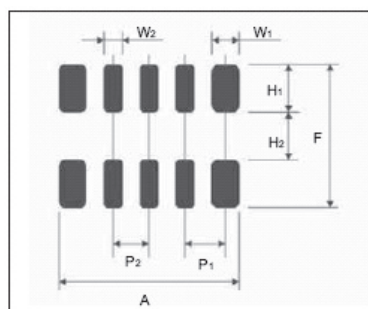
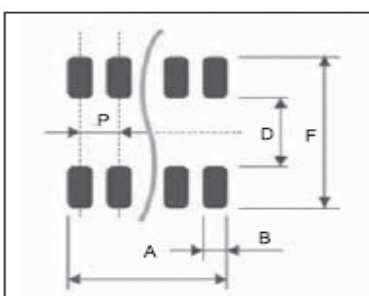

Storage and Handling Conditions:

1. Products are recommended to be used up within one year. Check solders ability in case shelf life extension is needed.
2. To store products with following condition:
 - Temperature :5 to 40°C
 - Humidity : 20 to 70% relative humidity
3. Caution:
 - a. Don't store products in a corrosive environment such as sulfide, chloride gas, or acid. It may cause oxidization of electrode, which easily be resulted in poor soldering
 - b. To store products on the shelf and avoid exposure to moisture.
 - c. Don't expose products to excessive shock, vibration, direct sunlight and so on

Precaution of Soldering

1. It is recommended to use a mildly activated rosin flux (less than 0.1% wt chlorine)
2. Excessive flux must be avoided
3. When water-soluble flux is used, enough washing is necessary
4. Two times limitations for reflow soldering is highly recommended
5. Solder repair by soldering iron
 - a. Max. 350°C for below 3 seconds is highly recommended
 - b. Do not directly contact termination to avoid thermal shock.
6. Prevent any external force on the products until solder is cooled

Mounting

1. Imperfect adjustment of mounting machine may cause the cracks, the chipping and the alignment error. Check and inspect the mounting machine in advance.
2. Set the backup pins in proper layout otherwise the components mounted on the backside of the board are damaged. Do not set these pins at the position of the nozzle.
3. Adjust the bottom dead point of dispenser away from the board when you apply adhesive.
4. Confirm that the products are corresponding to flow soldering when you perform it.
5. Pay attention to the amount of solder because improper amount of solder place large stress on the products and cause cracks or malfunctions.

Recommendation of Soldering Profiles:

In general application, the lead free (Pb-free) termination CRs are used and may be mounted on PCB by IR reflow or wave soldering process with lead-free solder material. The recommended soldering profiles are shown as Fig.1 & 2.

The lead-free termination CRs are also suitable on SMT process against lead-containing solder paste. But the soldering temperature should be higher than the melting point of solder paste 30°C at least.

If the optimized solder joint is requested, increasing soldering time, temperature and concentration of N₂ within oven are recommended. Advised IR reflow soldering profile is shown as Fig.3.

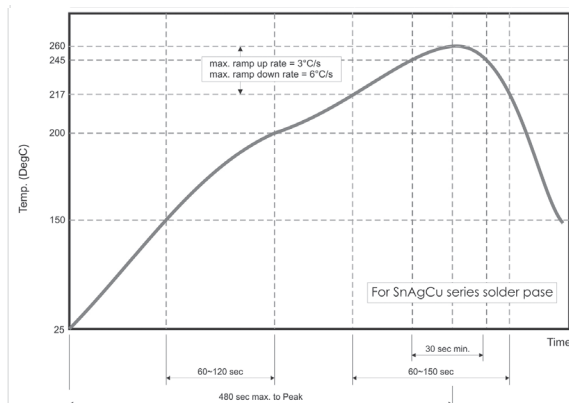

Fig. 1 Recommended IR reflow soldering profile for SMT process with SnAgCu series solder paste.

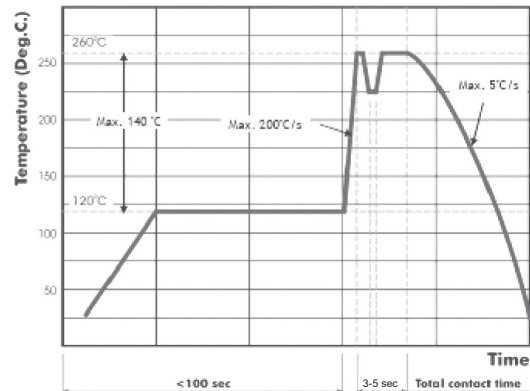

Fig. 2 Recommended wave soldering profile for SMT process with SnAgCu series solder.

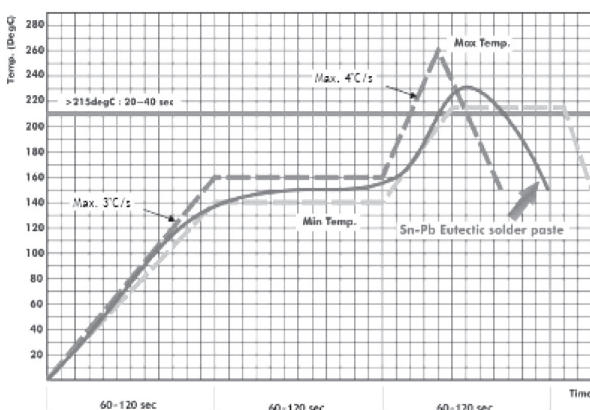

Fig. 3 Recommended reflow soldering profile for SMT process with eutectic SnPb solder paste.

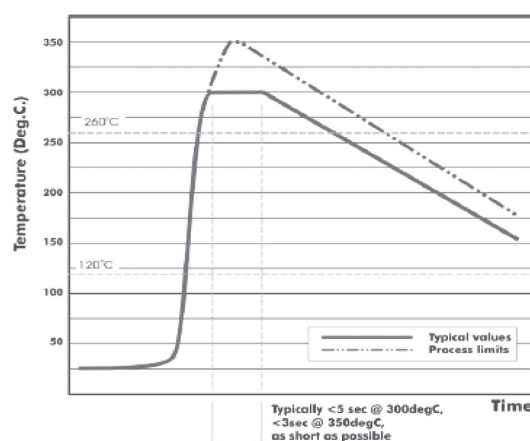

Fig. 4 Recommended soldering profile by manual with SnAgCu series solder.

Taiwan - Yang-Mei Plant / Sales Office

Walsin Technology Corporation
566-1, Kao-Shi Road, Yang-Mei,
Tao-Yuan, Taiwan
Tel: +886-3-475-8711
Fax: +886-3-475-7130
Email: info@passivecomponent.com

Taiwan - Kaohsiung Plant

Walsin Technology Corporation
1st, West 13 Street, K.E.P.Z.
Kaohsiung, Taiwan
Tel: +886-7-821-8171
Fax: +886-7-813-1661
Email: info@passivecomponent.com

China - Dalang Plant / Sales Office

Dongguan Walsin Tech. Electronics CO., Ltd.
Xiniupo Administrative Zone,
Dalang Town, Dongguan City,
Guangdong Province 523799
Tel: +86-769-831-15168
Fax: +86-769-831-15188
Email: stlin@passivecomponent.com

China - Suzhou Plant / Sales Office

Suzhou Walsin Technology Electronics Co., Ltd.
No. 369, Changyan Street,
Suzhou Industrial Park,
Jiangsu Province 215126
Tel: +86-512-628-36888
Fax: +86-512-628-37888
Email: davidcheng@passivecomponent.com

China - Guangzhou Plant / Sales Office

Pan Overseas (Guangzhou) Electronic Co., Ltd.
No. 277, Hong Ming Road, Eastern Section,
Guangzhou Economic and Technology
Development Zone, China
Tel: +86-20-8223-7476
Fax: +86-20-8223-7475
Email: info@passivecomponent.com

China - Chongqing Sales Office

Avenue of Stars Yongchuan District No.999
Chongqing , China
Tel: +86-512-628-36888 Ext:5329
Fax: +86-512-628-37888
Email: tommylee@passivecomponent.com

Germany - Munich Sales Office

Walsin Technology Corporation Europe
Stefan-George-Ring 29, 81929 Munich, Germany
Tel: +49-(0)89-9308-6475
Fax: +49-(0)89-9308-6464
Email: aw@passivecomponent.com

Singapore - Sales Office

WTC Singapore Sales Office, Singapore
8 Ubi View #04-01 Serial System Building
Singapore 408554
Tel: +65-6896-3877
Fax: +65-6861-3381
Email: michaelchee@sg.passivecomponent.com

United States - West Coast Sales Office

Walsin Technology Corporation, USA
39500 Stevenson Place Suite 101,
Fremont, CA 94539, USA
Tel: +1-214-708-5182
E-mail: fctseng@passivecomponent.com

JAPAN - Sales Office

WTC Japan Sales Office, Japan
8-4-17, Fukayanaka, Ayase-shi,
Kanagawa, 252-1107, Japan.
Tel: +81-467-71-0884
Fax: +81-467-71-0910
Email: tsakano@kamaya.co.jp



Walsin Technology Corporation

TAIWAN - WTC Yang-Mei Plant / Sales Office

Walsin Technology Corporation

566-1, Kao-Shi Road, Yang-Mei, Tao-Yuan, Taiwan

Tel: +886-3-475-8711

Fax: +886-3-475-7130

Email: info@passivecomponent.com

Kaohsiung Plant, Taiwan

Walsin Technology Corporation

1st, West 13 Street, K.E.P.Z. Kaohsiung, Taiwan

Tel: +886-7-821-8171

Fax: +886-7-813-1661

Email: info@passivecomponent.com



Jan 2014